

PRO 2022





#IZAR50yearsinternational



Carlos Pujana

CEO

IZAR Cutting Tools SAL

izar@izartool.com

Amorebieta 02.01.2022

Estimados clientes, colaboradores y amigos,

Este Catálogo Profesional supone la culminación de un trayecto que comenzó en 1998, con el primer catálogo de IZAR que tuve el honor de prologar.

Continuamos ampliando sin descanso la gama de soluciones innovadoras para nuestros clientes en brocas para metal, madera y pared, así como todo tipo de herramientas relacionadas con las mismas.

Ejemplo de ello, la nueva broca de Zirkonio en envase individual EV pack 1065, los rompe-machos 9016, la nueva gama de aceites de corte 3415 y los nuevos estuches de brocas 1459, que incluyen las medidas previas al roscado.

Reforzamos nuestro compromiso con la sostenibilidad y el medioambiente, consumiendo energía con garantía de origen 100% renovable y unimos a ello, incluso, nuestra gama de envasados OLATU, concebida bajo parámetros de eco-diseño que, como ya es bien conocido, supone una reducción del impacto ambiental en todo el ciclo de vida del producto de un 64%. Esta gama se ampliará, presentando importantes novedades y mejoras en un futuro muy cercano.

Hemos querido modernizar, no solo el diseño de las herramientas y los envasados, sino incluso el propio catálogo, que como podrán observar, con 400 páginas y 8.700 artículos, es el más amplio editado hasta la fecha. Ahora es más sencillo y fácil identificar que nunca antes la herramienta que necesitamos, y el modo más responsable y eficiente de utilizarla.

Finalmente, a pesar de nuestro compromiso con la estabilidad de precios, la evolución de las materias primas, de la energía y de los fletes, se han combinado de tal forma, que han generado la mayor espiral inflacionista imaginable. Esto nos obliga a actualizar nuestros precios, que se incrementan en el entorno de un 6%, como media, aproximadamente. No es un incremento lineal, sino que hemos querido ser cuidadosos y hemos evaluado el impacto de la subida de forma individual, artículo por artículo.

Todo ello viene además combinado con un reajuste de la política de descuentos, que tiene un impacto cero en nuestros distribuidores, pero que acerca los precios publicados a los precios reales de venta al usuario final, lo que es esencial en esta nueva era de las nuevas tecnologías y de la transparencia en la que vivimos.

Estamos muy agradecidos de contar con su confianza pues, sin ustedes, nada de lo que hacemos tendría sentido.

Dear customers, business partners and friends,

This Professional Catalogue is the culmination of a journey that began in 1998, with the first IZAR catalogue, which I had the honour of prefacing.

We continue to relentlessly expand the range of innovative solutions for our customers, in drill bits for metal, wood and masonry, as well as all types of related tools.

For example, the new 1065 Zirkonio drill bit in individual EV packaging, the 9016 tap breakers, the new 3415 range of cutting oils and the new 1459 drill bit sets, which include measures prior to threading.

We reinforce our commitment to sustainability and the environment, consuming energy with a guarantee of 100% renewable origin. We add to this our OLATU range of packaging, conceived under eco-design parameters which, as is already well known, means a 64% reduction in the environmental impact throughout the product's life cycle. This range will be expanded, with important new features and improvements in the very near future.

We wanted to modernise not only the design of the tools and packaging, but also the catalogue itself. As you will see, with 400 pages and 8,700 articles, it is the most extensive catalogue published to date. It is now simpler and easier than ever before to identify the tool we need, and the most responsible and efficient way to use it.

Finally, despite our commitment to price stability, the evolution of raw materials, energy and freight rates have combined in such a way as to generate the largest inflationary spiral imaginable. This forces us to update our prices, which increase by approximately 6% on average. It is not a linear increase; instead, we wanted to be careful and we have assessed the impact of the increase on an item-by-item basis.

This is combined with a readjustment of the discount policy, which has zero impact on our distributors, but brings the published prices closer to the real sales prices to the end user. This is essential in this new era of new technologies and transparency in which we live.

We are very grateful for your trust, as, without you, none of what we do would make sense.

Chers clients, collaborateurs et amis,

Ce catalogue professionnel est l'aboutissement d'un parcours qui a commencé en 1998, avec le premier catalogue IZAR, dont j'ai eu l'honneur de préfacer.

Nous continuons à élargir sans relâche la gamme de solutions innovantes pour nos clients en matière de forets pour le métal, le bois et la maçonnerie, ainsi que tous les outils connexes.

Citons par exemple les nouveaux forets Zirkonio en pack individuel EV 1065, les forets à mortaiser 9016, la nouvelle gamme d'huiles de coupe 3415 et les nouveaux coffrets de forets 1459, qui incluent les mesures préalables au taraudage.

Nous renforçons notre engagement envers la durabilité et l'environnement, en consommant de l'énergie avec une garantie d'origine 100 % renouvelable et nous ajoutons à cela notre gamme d'emballages OLATU, conçue selon des paramètres d'éco-conception qui, comme on le sait déjà, signifie une réduction de 64 % de l'impact environnemental tout au long du cycle de vie du produit. Cette gamme sera étendue, avec d'importantes nouveautés et améliorations dans un avenir très proche.

Nous avons voulu moderniser non seulement le design des outils et des emballages, mais aussi le catalogue lui-même, qui, comme vous pouvez le constater, avec 400 pages et 8 700 articles, est le catalogue le plus complet publié à ce jour. Il est aujourd'hui plus simple et plus facile que jamais d'identifier l'outil dont nous avons besoin, ainsi que la manière la plus responsable et la plus efficace de l'utiliser.

Enfin, malgré notre engagement en faveur de la stabilité des prix, l'évolution des matières premières, de l'énergie et des frets se sont combinés de manière à générer la plus grande spirale inflationniste imaginable. Cela nous oblige à actualiser nos prix, qui augmentent d'environ 6 % en moyenne. Il ne s'agit pas d'une augmentation linéaire, mais nous avons voulu être prudents et nous avons évalué l'impact de l'augmentation article par article. Ceci est combiné à un réajustement de la politique de réductions, qui a un impact nul sur nos distributeurs, mais rapproche les prix publiés des prix de vente réels à l'utilisateur final, ce qui est essentiel dans cette nouvelle ère de nouvelles technologies et de transparence dans laquelle nous vivons.

Nous vous remercions vivement de votre confiance, car sans vous, rien de ce que nous faisons n'aurait de sens.

UNA EMPRESA CON VALORES

A Company With Values

Une entreprise avec des valeurs

Valores IZAR

- La honestidad
- El enfoque al cliente
- La adaptación al cambio
- El compromiso con la calidad y con el trabajo bien hecho
- El trabajo en equipo
- El interés por la tecnología y por la innovación

IZAR Values

- Honesty
- Customer focus
- Adaptation to change
- Commitment to quality and to the job well done
- Team-work
- Interest for technology and innovation

Valeurs IZAR

- L'honnêteté
- L'orientation client
- L'adaptation au changement
- L'engagement pour la qualité et pour le travail bien fait
- Le travail en équipe
- L'intérêt pour la technologie et l'innovation

UNA EMPRESA SOCIALMENTE RESPONSABLE

A socially responsible company

Une entreprise socialement responsable



Premio PYME del año 2021 en Bizkaia

SME of the year 2021 in Bizkaia award

Prix PME de l'année 2021 en Biscaye



COMPROMETIDOS CON LA FABRICACIÓN Y EL EMPLEO

Committed to manufacturing and jobs

Engagés dans la fabrication et l'emploi



LA CALIDAD TOTAL NOS DISTINGUE

Total quality makes the difference

La qualité totale nous différencie



EXPORTADORES A NIVEL MUNDIAL

A Major Figure in the global market

Présent sur tous les marchés mondiaux

Export Sales

Tel. (+34) 94 630 02 46

Fax. (+34) 94 630 02 37

export@izartool.com

Ventes France

Tel. (+34) 94 630 02 45

Fax. (+34) 94 630 02 37

france@izartool.com



1 Idoia Luengas

iluengas@izartool.com

3 Joseba Del Pozo

Chef Produit Technique
jdelpozo@izartool.com

5 Mikel Goyarrola

Export Manager
mgoyarrola@izartool.com

7 Maite Olariaga

molariaga@izartool.com

9 Ostaizka Badiola

obadiola@izartool.com

2 Aitxiber Soutiño

asoutino@izartool.com

4 Itziar Urrutxua

iurrutxua@izartool.com

6 Xabier Asensio

Export Area Manager
xasensio@izartool.com

8 Juan Garaizar

General Sales Manager
jgaraizar@izartool.com



Presencia Internacional
International Presence
Présence Internationale

Top Service
Opening Hours:
8.00 - 19.00

Service 24h
en France

Pour commandes de articles
en stock reçues avant 14.30h

LÍDERES EN MERCADO NACIONAL

Domestic market leaders

Leader sur le marché national



Ventas Mercado Nacional

Tel. 94 630 02 41

Fax. 94 630 02 36

comercial@izartool.com

1 Leticia González
Administrativa Comercial

3 Mari Feli Arrizabalaga
Administrativa Comercial

5 Juan Garaizar
Director Comercial
jgaraizar@izartool.com

7 Mónica González
Directora de Ventas Nacional
mgonzalez@izartool.com

9 Yolanda Barrena
Administrativa Comercial

2 Oiane Gortazar
Product Manager
Professional
ogortazar@izartool.com

4 Olaia Etxebarria
Administrativa Comercial

6 Iskander Ibarriuri
Asistencia Técnica
iibarriuri@izartool.com

8 Leire Layana
Administrativa Comercial

10 Iker Beobide
Product Manager Industrial
ibeobide@izartool.com

11 Isabel Hernández
Administrativa Comercial



Servicio 24h
Horario de
Atención al Cliente:
8.00 - 19.00



ÍNDICE VISUAL

Visual Index
Index visuel

METAL





































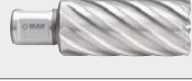







				Pag.
Ref. 1021	HSSE 5% Co		Multi INOX	16
MULTI-PACK				
Ref. 1004	HSSE 5% Co		Multi INOX	19
BLISTER				
Ref. 1016	HSSE 5% Co	DIN 338 N	Hard Mats. Duros	22
MULTI-PACK				
Ref. 1006	HSSE 5% Co	DIN 338 N	Hard Mats. Duros	26
BLISTER				
Ref. 1020	HSSE 5% Co		INOX Stainless	31
MULTI-PACK				
Ref. 1005	HSSE 5% Co		INOX Stainless	34
BLISTER				
Ref. 1027	HSSE 5% Co	L30 mm		37
MULTI-PACK				
Ref. 9015	Metal Duro			38
Ref. 9289	MD/HM Carbure			38
New!				
Ref. 9100	Metal Duro			39
Ref. 1015	HSS + ZIRKONIO	DIN 338 N		40
MULTI-PACK				
Ref. 1065	HSS + ZIRKONIO	DIN 338 N		43
BLISTER				
New!				
Ref. 1010	HSS + TIN	DIN 338 N	Usos General	45
MULTI-PACK				
Ref. 1001	HSS + TIN	DIN 338 N	Usos General	50
BLISTER				
Ref. 1013	HSS + TIALSIN		Max. 5 mm	56
MULTI-PACK				
Ref. 1002	HSS		Max. 5 mm	60
BLISTER				
Ref. 1007	HSS	L30 mm		65
BLISTER				
Ref. 1025	HSS	DIN 338 N		67
MULTI-PACK				

				Pag.
Ref. 1660	HSS		Max. 3 mm	68
MULTI-PACK				
Ref. 1050	HSS	DIN 1897 N	Extra-Corta	69
MULTI-PACK				
Ref. 1030	HSS	DIN 340 N	Larga Long	70
MULTI-PACK				
Ref. 1003	HSS	DIN 340 N	Larga Long	72
MULTI-PACK				
Ref. 1040	HSS	DIN 1869 N	Extra Larga	74
Ref. 1090	HSS	Laminada Rolled Laminé		75
MULTI-PACK				
Ref. 1009	HSS	Laminada Rolled Laminé		75
BLISTER				
Ref. 1110	HSS	DIN 345 N	Cónica Taper	76
Ref. 1802				79
Ref. 1806			Reversible	80
Ref. 1804			Dcha. Right	80
Ref. 1803			Dcha. Right	81
Ref. 1101	HSS	DIN 2185		84
Ref. 1102	HSS	DIN 2187		84
Ref. 1103	HSS			85
MÁQUINA AFILADORA BROCAS Drill Bit Sharpening Machine Machine affûteuse forets				
Ref. 9994				86
Ref. 1602	HSS		Max. 4 mm	87

ÍNDICE VISUAL

Visual Index
Index visuel

METAL

				Pag.					Pag.
Ref. 1612	HSS	Espiral		89	Ref. 4061	HSS	Serie Larga Long Length Série longue		109
Ref. 1607	HSSE 5% Co			90	Ref. 4062	HSS	S. Extra-Larga Extra-Long S. S. extra-longue		110
Ref. 1617	HSSE 5% Co	Espiral		91	Ref. 1667	HSS			111
Ref. 1603	HSS			92	Ref. 1663	INOX Stainless	PVC Aluminio		113
Ref. 1609	HSSE 5% Co			93	Ref. 1665	INOX Stainless	PVC Aluminio		114
Ref. 1611	HSS			94	Ref. 1636	HSS	New!		115
Ref. 1606	HSS			95	Ref. 2010	HSS	DIN 206 B ISO 236		116
Ref. 1610	HSS	DIN 3126		96	Ref. 2015	HSS	Reforzado Reinforced Renforcée		117
Ref. 4078	TCT	Serie Corta Short Length Série courte		97	Ref. 2016	HSS	Con guía Guided Avec guide		117
Ref. 4077	TCT	Serie Larga Long Length Série longue		98	Ref. 2575	HSSE 5% Co	DIN 335 C		118
Ref. 4070	HSS	Serie Corta Short Length Série courte		99	Ref. 2530	HSS	DIN 373 Allen		119
Ref. 4071	TCT	Serie Larga Long Length Série longue		100	Ref. 2572	HSSE 5% Co			120
Ref. 4072	HSS	S. Extra-Larga Extra-Long S. S. extra-longue		101	Ref. 3030	HSS	DIN 352 Mano Hand Main	  	121
Ref. 4079	HSS	Serie Corta Short Length Série courte		102				PACK	
Ref. 4076	HSS	DOBLE WELDON		103	Ref. 3003	HSS	DIN 352 Mano Hand Main	  	122
Ref. 4074	DOBLE WELDON			104				BLISTER	
Ref. 4067	TCT	Serie Larga Long Length Série longue		107	Ref. 3036	HSSE 5% Co	DIN 352 / 2181 INOX Stainless	  	124
Ref. 4060	HSS	Serie Corta Short Length Série courte		108				PACK	
					Ref. 3037	HSSE 5% Co	DIN 352 / 2181 INOX Stainless		125

METAL

















				Pag.
Ref. 3020	HSS	DIN 2181	Nº1 Nº3	126
				
PACK				
Ref. 3010	HSS	DIN 352 / 2181	Nº3	128
				
PACK				
Ref. 3001	HSS	DIN 352	Nº3	130
				
BLISTER				
Ref. 3023	HSS	DIN 352		131
				
PACK				
Ref. 3040	HSS	ISO 529	Nº3	132
				
PACK				
Ref. 3032	HSS	DIN 352	Whitworth	133
				
PACK				
Ref. 3012	HSS	DIN 352	Whitworth	134
				
PACK				
Ref. 3026	HSS	DIN 5157	BSPP (Gas)	135
				
PACK				
Ref. 3016	HSS	DIN 5157	BSPP (Gas)	135
				
PACK				
Ref. 3100	HSSE 5% Co	DIN 371	Máq.	136
				
PACK				
Ref. 3200	HSSE 5% Co	DIN 376/ 374	Máq.	137
				
PACK				
Ref. 3150	HSSE 5% Co	DIN 371	Máq.	139
				
PACK				
Ref. 3250	HSSE 5% Co	DIN 376/ 374	Máq.	140
				
PACK				

				Pag.
Ref. 3119	HSSE 5% Co	ISO 529		141
				
PACK				
Ref. 3113	HSSE 5% Co	ISO 529		142
				
PACK New!				
Ref. 3109	HSS	ISO 529		143
				
PACK				
Ref. 3157	HSS	ISO 529		145
				
PACK				
Ref. 3500	M / MF	HSS	DIN 223	147
				
PACK				
Ref. 3005	HSS	DIN 223	Mano Hand Main	149
				
Ref. 3536	HSSE 5% Co	DIN 22568	INOX Stainless	150
				
PACK				
Ref. 3510	HSS	ISO 529		151
				
PACK				
Ref. 3502	DIN 223	Whitworth		151
				
PACK				
Ref. 3546	HSSE 5% Co	DIN 24231	INOX Stainless	152
				
PACK				
Ref. 3506	BSPP (Gas)	HSS	DIN 24231	152
				
PACK				
Ref. 3191	DIN 1814			153
				
Ref. 3912	"T" + Crique			153
				
Ref. 9016	MD/HM Carbure	IZAR Std.		154
				
New!				
Ref. 3409				155
				
Ref. 3181	DIN 225			156
				

ÍNDICE VISUAL

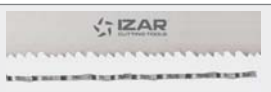
Visual Index
Index visuel

METAL













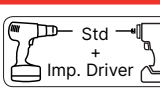

				Pag.					Pag.	
<div style="border: 2px solid red; padding: 5px;"> <p>New! Ref. 3415 ACEITES DE CORTE Y REFRIGERANTES Cutting Oils & Water Soluble Fluids Huiles de coupe et lubrifiants</p>  <p>UNI INOX ALU Universal Heavy Duty Non Ferrous</p> <p>STD TOP Standard Top Line</p> </div>				159						
Ref. 3300	HSS	M / MF		165	Ref. 9240	MD/HM Carbure	Tipo B Type		176	
Ref. 3305	HSS	M / MF		166	Ref. 9230	MD/HM Carbure	Tipo A Type		177	
Ref. 3303				167	Ref. 9231	MD/HM Carbure	Tipo C Type	Radial Radial Hemisférique	177	
Ref. 3307				167	Ref. 9237	MD/HM Carbure	Tipo E Type	Gota Oval Ovale	178	
Ref. 9260	K20 + ALTiN	Tipo B Type		170	Ref. 9238	MD/HM Carbure	Tipo D Type	Esférica Ball Sphérique	178	
Ref. 9250	K20 + ALTiN	Tipo A Type		171	Ref. 9247	MD/HM Carbure	Tipo L Type	Cónica Redon. Ball Nosed Cone Conique rayon	179	
Ref. 9251	K20 + ALTiN	Tipo C Type	Radial Radial Hemisférique	171	Ref. 9248	MD/HM Carbure	Tipo F Type	Ojiva Redon. Ball Nosed Tree Ogive rayon	179	
Ref. 9252	MD/HM K20	Tipo N Type	Cono Invertido Inverted Cone Coupe en bout	172	Ref. 9674	MD/HM Carbure	IZAR Std.		182	
Ref. 9254	K20 + ALTiN	Tipo G Type	Ojiva Tree Ogive	172	Ref. 9459	MD/HM Carbure	1Z	Grabado Engraving Gravure	183	
Ref. 9255	MD/HM K20	Tipo M Type	Cónica Cone Conique	173	Ref. 9419	K10F + ALTiN	W	Alumi-nio	184	
Ref. 9256	MD/HM K20	Tipo K Type	Cónica 90° 90° Cone Conique 90°	173	Ref. 9411	K10F + ALTiN	W	Alumi-nio	184	
Ref. 9257	MD/HM K20	Tipo E Type	Gota Oval Ovale	174	Ref. 4412	HSS	W	Alumi-nio	185	
Ref. 9258	K20 + ALTiN	Tipo D Type	Esférica Ball Sphérique	174	Ref. 4414	HSS	W	Alumi-nio	185	
Ref. 9266	MD/HM K20	Tipo H Type	Llama Flame Flamme	175	Ref. 4223	HSSE 8% Co			187	
Ref. 9267	MD/HM K20	Tipo L Type	Redondeada Ball Nosed Conique rayon	175	Ref. 4228	HSSE 8% Co	4% Cr		189	
Ref. 9268	K20 + ALTiN	Tipo F Type	Ojiva redondeada Ball Nosed Tree Ogive rayon	176	Ref. 4229	HSSE 8% Co	4% Cr		191	
					Ref. 1994	TPI 24			192	
					Ref. 1999	Bimetal	TPI 18-24 32	INOX Stainless		192
					Ref. 1997	HSS	TPI 18-24 32	No Flexible		192

ÍNDICE VISUAL









Visual Index
Index visuel







METAL

				Pag.
Ref. 1996	CrV	TPI 24		192
Ref. 8901	DIN 4971	ISO 1	Cilindrado 70° 70° Straight Cylindrage 70°	194
Ref. 8900	DIN 4972	ISO 2	Escuadrado 45° 45° Bent Décolletage 45°	194
Ref. 8904	DIN 4976	ISO 4	Ranurado Ext. Wide Face Square Rainurage ext.	195
Ref. 8910	DIN 4980	ISO 6	Escuadrado 90° 90° Offset Side Décolletage 90°	195
Ref. 8920	DIN 4981	ISO 7	Tronzado Parting Tronçonnage	196
Ref. 8925	DIN 4973	ISO 8	Mandrinado Boring Straight Alésage	196
Ref. 8930	DIN 4974	ISO 9	Cilindrado int. Internal Sharped Cylindrage int.	197
Ref. 8940	DIN 4975	ISO 10	Cilindrado Recto Sharped Straight Cylindrage Droit	197
Ref. 8950	DIN 263	ISO 11	Ranurado Int. Int. Undercutting Rainurage int.	198
Ref. 8960	DIN 282	ISO 12	Roscado Ext. Ext. Threading Taraudage ext.	198
Ref. 8970	DIN 283	ISO 13	Roscado Int. Int. Threading Taraudage int.	199

				Pag.
Ref. 8990	HSSE 10% Co	DIN 4964B		200
Ref. 8991	HSSE 10% Co	DIN 4964A		200
Ref. 8992	HSSE 10% Co	DIN 4964E		201
Ref. 8352	Std + Imp. Driver			204
Ref. 8350				204
Ref. 8325	3-25 mm	1/8-1"		206
Ref. 8330	3-30 mm	1/8-1" 1/8		206
Ref. 8335	3-35 mm	1/8-1" 3/8		206
Ref. 8341				206
Ref. 8326	26 mm	1" Inox + Teflon		207
Ref. 8342	42 mm	1" 5/8 Inox + Teflon		207
Ref. 8321				207
Ref. 8345				208

CONSTRUCCIÓN Construction

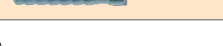
				Pag.
Ref. 1891	SDS plus			210
Ref. 1890	SDS plus			214
Ref. 1695	SDS plus			219
Ref. 1892	SDS max			220

				Pag.
Ref. 1894	SDS max			222
Ref. 1697	SDS max			223
Ref. 1875	SDS max			225
Ref. 1870	SDS plus			226

ÍNDICE VISUAL





































































Visual Index
Index visual

CONSTRUCCIÓN Construction

Ref.	Icons	Pag.
1872	SDS max	227
1871	New!	229
1882	Porcelain	230
1879	Porcelain	231
1883	Porcelain	232
1877	Granito	233
1886	MD/HM TCT	234
1846	MD/HM TCT	235
1880	MD/HM TCT	238
1881	Ceramic	242
1876	Ceramic New!	243
1836	MD/HM Ceramic	244
1601	MD/HM TCT	245
1645	HSSE 8% Co	247
1647	Ceramic	250
1661	Ceramic	252
1662	Ceramic	253

Ref.	Icons	Pag.
1860		256
1851		258
1852		258
1858		259
1854		259
1855	Abrasivos	260
1853	Porcelain	260
1861		261
1857		261
1864		262
1862		262
1863		263
1849		263
8309	9 mm	264
8318	18 mm New!	264
8319	19 mm New!	265

MADERA Wood Bois

				Pag.					Pag.
Ref. 1641	HSS			268	Ref. 1670	MD/HM Carbure			287
Ref. 1640	CrV			270	Ref. 1671	MD/HM Carbure			287
Ref. 1651	Heavy Duty	 		274	Ref. 1672	MD/HM Carbure			288
Ref. 1650		 		276	Ref. 1673	MD/HM Carbure			288
Ref. 1655	CrV			278	Ref. 1681	MD/HM Carbure			288
Ref. 1644	SDS plus	 		280	Ref. 1682	MD/HM Carbure			289
Ref. 1643		 		281	Ref. 1686	MD/HM Carbure			289
Ref. 1621	CrV			282	Ref. 1615	Diente MD			291
Ref. 1639	HSS			283	Ref. 1620	C60			292
Ref. 1637	C45	New!		284	Ref. 1625				292
Ref. 1685	MD/HM Carbure			285	Ref. 1689	MD/HM Carbure	EVA		293
Ref. 1669	MD/HM Carbure			285	Ref. 9001	MD/HM Carbure	 Max. 1 mm		293
Ref. 1679	MD/HM Carbure			285	Ref. 7009	MD/HM Carbure	 Ceramic		294
Ref. 1678	MD/HM Carbure			286	Ref. 7002	HSS	 Pladur Escayola		294
Ref. 1674	MD/HM Carbure			286	Ref. 7003	HSS	 Auto center		295
Ref. 1676	MD/HM Carbure			286	Ref. 7001	HSS			295
Ref. 1677	MD/HM Carbure			287	Ref. 1690	MD/HM Carbure			296

ÍNDICE VISUAL

Visual Index
Index visuel

SIERRAS Saw Blades Lames scies

Ref.	Iconos	Imagen	Pag.
2940	STARLOCK, Madera		301
2910	STARLOCK, Madera		305
2930	STARLOCK, Especial		310
2950	QUICK-FIT, Especial		318
1950	Sable, Madera		322
1920	Sable, Madera		325

Ref.	Iconos	Imagen	Pag.
1960	Sable, Especial		330
1940	Calar, Inserción "T", Madera		338
1910	Calar, Inserción "T", Madera		347
1930	Calar, Inserción "T", Especial		352
1945	Calar, Inserción "U", Madera		353
1915	Calar, Inserción "U", Madera		355

PUNTAS ATORNILLAR Screwdriver Bits Embouts vissage

Ref.	Iconos	Imagen	Pag.
1520	Std.		358
1521	Torsión		362
1522	Zirkonio		363

Ref.	Iconos	Imagen	Pag.
1523	S2 material, New!		363
1524	Std., New!		364

DOBLE BLISTER Double Blister Double Blister

Ref.	Iconos	Imagen	Pag.
M021	Cobalto 5% HSSE, Madera		370
M020	Cobalto 5% HSSE, Madera		371
M013	HSS, Madera		372
M007	HSS, L30, Madera		373
M890	SDS plus, Madera		374
M882	Punta MD/HM Point, Sin percusión		375

Ref.	Iconos	Imagen	Pag.
M886	Punta MD/HM Point, Madera, Percusión		376
M880	Punta MD/HM Point, Madera, Percusión		377
M881	Madera		378
M836	Punta MD/HM Point, Sin percusión		378
M640	CrV		379
M650	Madera		380



METAL

Metal
Métal

15

BROCAS

Drill Bits
Forets

16

PORTA-BROCAS Y ACCESORIOS

Drill Chucks & Accessories
Mandrins et accessoires

79



CONSTRUCCIÓN

Construction
Construction

209



MADERA

Wood
Bois

267

BROCAS

Drill Bits
Forets

268

FRESAS

Router Cutters
Fraises

285

SIERRAS

Saw Blades
Lames scies

297

OSCILANTES MULTI-FUNCIÓN

Oscillating Multi-Tools
Outils Multifonction

298

SIERRAS SABLE

Sabre Saw Blades
Lames scie sabre

320

SIERRAS CALAR

Jig Saw Blades
Lames scies sauteuses

336

PUNTAS

ATORNILLAR

Screwdriver Bits
Embouts vissage

357

BROCAS ESPECIALES

Special Drill Bits
Forets Spéciales

87

FRESAS HUECAS

Hole-Cutters
Fraises à carotter

97

CORONAS

Hole Saws
Trépan

111

ESCARIADORES

Reamers
Alésoirs

116

AVELLANADORES

Countersinks / Counterbores
Outils

118

MACHOS Y COJINETES

Taps & Dies
Tarauds et filières

121

HERRAMIENTAS SDS PLUS

SDS plus Tools
Outils SDS plus

210

HERRAMIENTAS SDS MAX

SDS max Tools
Outils SDS max

220

ADAPTADOR iCONNECT

iConnect Adaptor
Adaptateur iConnect

224

CINCELES

Chisels
Burins

226

ACEITE / LUBRICANTE CORTE

Cutting Oil / Coolant
Huile / Lubrifiant de coupe

159

REPARADORES ROSCAS

Thread Repairs
Filets rapportes

164

FRESAS ROTATIVAS, FRESAS FRONTALES

Rotary Burrs, End Mills
Fraises limes rotativas, Fraises

170

HOJAS DE SIERRAS DE CINTA

Band Saw Blades
Lames de scie à ruban

186

HERRAMIENTAS TORNEADO

Brazed Turning Tools
Outils de tour

193

BROCAS MANGO CILÍNDRICO

Straight Shank Drill Bits
Forets queue cylindrique

230

CORONAS

Hole Saws
Trépan

247

DISCOS DIAMANTE

Diamond Cutting Blades
Disques diamant

257



DOBLE BLISTER

Double Blister
Double Blister

369

METAL

Metal
Métal

370

CONSTRUCCIÓN

Construction
Construction

374

MADERA

Wood
Bois

379

PRESENTACIONES

Presentations
Presentations

381

PRESENTACIÓN IZAR EN LÍNEA

IZAR Line Presentation
Presentation IZAR ligne

382

PRESENTACIÓN IZAR EN CASCADA

IZAR Cascade Presentation
Presentation IZAR cascade

390

EXPOSITORES APILABLES

Stacking Exhibitors
Présentoirs apilables

394



METAL

Metal
Métal

BROCAS

Drill Bits
Forets

16

MACHOS Y COJINETES

Taps & Dies
Tarauds et filières

121

PORTABROCAS Y ACCESORIOS

Drill Chucks & Accessories
Mandrins et accessoires

79

ACEITE / LUBRICANTE CORTE

Cutting Oil / Coolant
Huile / Lubrifiant de coupe

159

BROCAS ESPECIALES

Special Drill Bits
Forets spéciales

87

REPARADORES ROSCAS

Thread Repairs
Filets rapportes

164

FRESAS HUECAS

Hole-Cutters
Fraises à carotter

97

FRESAS ROTATIVAS, FRESAS FRONTALES

Rotary Burrs, End Mills
Fraises limes rotatives, fraises

170

CORONAS

Hole Saws
Trépan

111

HOJAS DE SIERRAS DE CINTA

Band Saw Blades
Lames de scie à ruban

186

ESCARIADORES

Reamers
Alésoirs

116

HERRAMIENTAS TORNEADO

Brazed Turning Tools
Outils de tour

193

AVELLANADORES

Countersinks / Counterbores
Outils

118

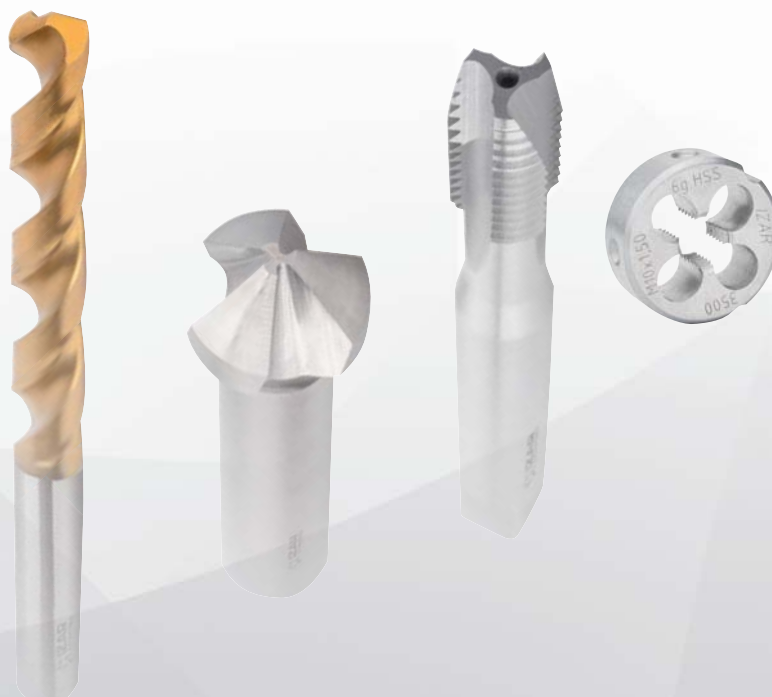

BROCAS

Drill Bits
Forets

Ref. **1021**

BROCA UNIVERSAL COBALTO MULTI INOX

Multi-STAINLESS Cobalt Universal Drill Bit
Foret universel cobalt Multi INOX



BOROA



Aceros <850 N/mm ² Steel / Aciers	INOX Stainless Steel Acier INOX	Cobre Copper Cuivre	Aluminio Aluminium
---	--	----------------------------------	------------------------------

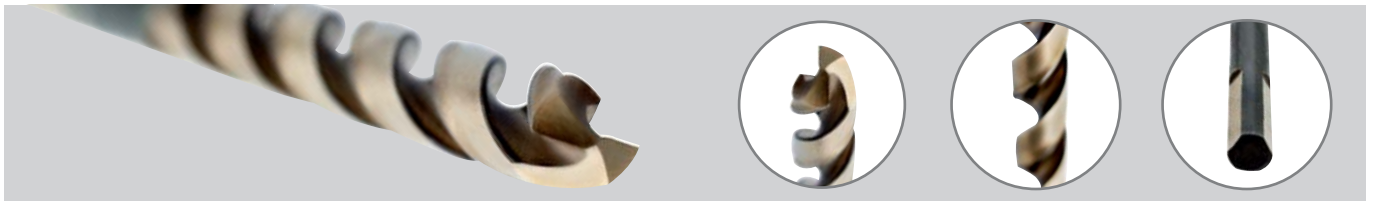

Ángulo de Punta 135°:

- Especial taladro mano.
- Aguzado de gran precisión.
- Menor fuerza de corte.
- Buen centrado superficies curvas.

Hélice 40°:

- Excelente evacuación de viruta.
- Taladrado más rápido y estable.
- Agujeros precisos hasta el final.

Mango de 3 Planos:

- Óptimo agarre y sujeción.
- Menor esfuerzo.
- Evita que se resbale la broca.
- Inmejorable transmisión de la energía.

135° Point Angle:

- Special portable drilling machine.
- High precision Split Point.
- Lower cutting-forces.
- Good centering on concave surfaces.

40° Helix:

- Excellent chip removal.
- Faster & stable drilling.
- Accurate holes right to the end.

3-Flat Shank:

- Optimum fixing.
- Low effort.
- No spinning in the drill-chuck.
- Ideal energy-transmission.

Angle de pointe 135°:

- Perceuses à main
- Affûtage précision
- Force de coupe inférieure
- Autocentrage surfaces courbes

Helix 40°:

- Excellente évacuation copeaux
- Perçage plus rapide et stable
- Trous précis jusqu'au bout

Queue 3 plans:

- Fixation optimale
- Effort inférieur
- Pas de glissement du foret
- Transmission d'énergie parfait

D	L	I	📦	Nº	€
mm	mm	mm		Art.	
1,00	34	12	10	25641	2,58
1,25	38	16	10	25642	3,07
1,50	40	18	10	25644	2,46
1,75	46	22	10	69953	3,07
2,00	49	24	10	25645	2,46
2,25	53	27	10	25646	2,71
2,50	57	30	10	25647	2,24
2,75	61	33	10	25648	2,71
3,00	61	33	10	25650	2,18
3,20	65	36	10	25710	2,69
3,25	65	36	10	25728	2,69
3,30	65	36	10	25730	2,69
3,50	70	39	10	25733	2,64
3,75	70	39	10	25738	3,19
4,00	75	43	10	25744	2,87
4,20	75	43	10	25751	3,19
4,25	75	43	10	25756	3,19
4,50	80	47	10	25762	3,19
4,75	80	47	10	25764	3,55
5,00	86	52	10	25769	3,42
5,20	86	52	10	25774	4,24

D	L	I	📦	Nº	€
mm	mm	mm		Art.	
5,25	86	52	10	25777	4,00
5,50	93	57	10	25780	4,32
5,75	93	57	10	25786	4,83
6,00	93	57	10	25788	4,61
6,25	101	63	10	25790	5,29
6,50	101	63	10	25793	5,38
6,75	109	69	10	25795	6,32
6,80	109	69	10	25798	6,30
7,00	109	69	10	25801	5,86
7,25	109	69	10	25803	8,05
7,50	109	69	10	25805	6,24
7,75	117	75	10	69952	9,66
8,00	117	75	10	25807	7,30
8,25	117	75	5	25809	9,29
8,50	117	75	5	25811	7,63
8,75	125	81	5	69950	11,71
9,00	125	81	5	25813	9,71
9,10	125	81	5	48842	13,77
9,20	125	81	5	48845	13,77
9,25	125	81	5	69949	12,95
9,30	125	81	5	48848	13,77

D	L	I	📦	Nº	€
mm	mm	mm		Art.	
9,50	125	81	5	25815	10,05
9,75	133	87	5	69947	15,27
10,00	133	87	5	25817	11,10
10,20	133	87	1	32666	14,96
10,25	133	87	1	25819	19,50
10,50	133	87	1	25821	14,96
10,75	142	94	1	69946	21,50
11,00	142	94	1	25823	16,51
11,10	142	94	1	48851	22,68
11,20	142	94	1	48854	22,68
11,25	142	94	1	69945	23,55
11,30	142	94	1	48857	22,68
11,50	142	94	1	25825	19,00
11,75	142	94	1	69944	24,39
12,00	151	101	1	25827	20,37
12,25	151	101	1	69943	25,87
12,50	151	101	1	25829	22,67
12,75	151	101	1	69941	27,00
13,00	151	101	1	25831	23,00
14,00	160	108	1	81564	24,61

Expo
1021

BROCA UNIVERSAL COBALTO MULTI INOX

Multi-STAINLESS Cobalt Universal Drill Bit
Foret universel cobalt Multi INOX



Cuartos / Quarters / Quarts

ø	1	1,5	2	2,5	3	3,25
Pcs	10	10	10	10	10	10
ø	3,5	4	4,25	4,5	5	
Pcs	10	10	10	10	10	
ø	5,5	6	6,5	7		
Pcs	10	10	10	10		
ø	7,5	8	8,5	9		
Pcs	10	10	10	10		
ø	9,5	10	11	12	13	
Pcs	5	5	2	2	2	

Nº Art. 57527: 1.035,50 €

Previos Roscado / Before Threading / Pré-Tarudage

ø	1	1,5	2	2,5	3	3,3
Pcs	10	10	10	10	10	10
ø	3,5	4	4,2	4,5	5	
Pcs	10	10	10	10	10	
ø	5,5	6	6,5	6,8		
Pcs	10	10	10	10		
ø	7	7,5	8	8,5		
Pcs	10	10	10	10		
ø	9	9,5	10	10,2	11	12
Pcs	10	5	5	2	2	2

Nº Art. 57981: 1.128,37 €

Línea 1m
1021

BROCA UNIVERSAL COBALTO MULTI INOX

Multi-STAINLESS Cobalt Universal Drill Bit
Foret universel cobalt Multi INOX



Cuartos / Quarters / Quarts

1,5 10	3	4	5	6	7	8	9	10	12	mm pcs
	10	10	10							
1 10	2,5	3,5	4,5	5,5	6,5	7,5	8,5	9,5	11	13
	10	10	10							

Nº Art. 71647: 1.035,50 €

Previos Roscado / Before Threading / Pré-Tarudage

1,5 10	3	4	5	6	7	8	9,5	10,2	12	mm pcs
	10	10	10				5			
1 10	2,5	3,5	4,5	5,5	6,5	7,5	9	10	11	13
	10	10	10				10			

Nº Art. 71648: 1.128,37 €

Cabinet 1021

BROCA UNIVERSAL COBALTO MULTI INOX

Multi-STAINLESS Cobalt Universal Drill Bit

Foret universel cobalt Multi INOX



176 Pcs

∅	1	1,5	2	2,5	3	3,5	4	4,5
Pcs	10	10	10	10	10	10	10	10
∅	5	5,5	6	6,5	7			
Pcs	10	10	10	10	10			
∅	7,5	8	8,5	9				
Pcs	10	10	5	5				
∅	9,5	10	10,5	11				
Pcs	5	5	1	1				
∅	11,5	12	12,5	13				
Pcs	1	1	1	1				

N° Art. 55448: **886,70 €**



Ref. **1004**

BROCA UNIVERSAL COBALTO MULTI INOX

Multi-STAINLESS Cobalt Universal Drill Bit
Foret universel cobalt Multi INOX



BOROA



Aceros <850 N/mm ² Steel / Aciers	INOX Stainless Steel Acier INOX	Cobre Copper Cuivre	Aluminio Aluminium
---	--	----------------------------------	------------------------------



D mm	L mm	I mm		Nº Art.	€
1,00	34	12	2	55605	5,99 *
1,50	40	18	2	55606	5,70 *
2,00	49	24	2	34051	5,70 *
2,50	57	30	2	34052	5,18 *
3,00	61	33	2	34053	5,07 *
3,25	65	36	2	34054	6,00 *
3,30	65	36	2	39917	6,00 *
3,50	70	39	2	34055	5,91 *
4,00	75	43	2	34056	6,38 *
4,20	75	43	1	39918	3,58
4,25	75	43	1	34057	3,58
4,50	80	47	1	34058	3,58
5,00	86	52	1	34059	3,82
5,50	93	57	1	34060	4,82
6,00	93	57	1	34061	5,14

D mm	L mm	I mm		Nº Art.	€
6,50	101	63	1	34062	5,80
6,80	109	69	1	39919	6,78
7,00	109	69	1	34063	6,32
7,50	109	69	1	34064	6,73
8,00	117	75	1	34065	7,90
8,50	117	75	1	34066	8,24
9,00	125	81	1	34067	10,48
9,50	125	81	1	72629	10,84
10,00	133	87	1	34068	11,66
10,20	133	87	1	39920	15,72
10,50	133	87	1	74942	15,72
11,00	142	94	1	34069	17,32
11,50	142	94	1	74943	19,95
12,00	151	101	1	34070	21,39
13,00	151	101	1	34071	24,15

* € = 2 uds.



Línea 1m
1004

BROCA UNIVERSAL COBALTO MULTI INOX

Multi-STAINLESS Cobalt Universal Drill Bit
Foret universel cobalt Multi INOX



ø	1	1,5	2	2,5	3	3,25	3,5	4	4,25	4,5	5	5,5	6	6,5	7	7,5	8	9	10
Packs	3	3	5	5	10	5	5	10	5	5	10	5	10	5	5	3	5	3	3

Ref. 4995 - Nº Art. 70933: 599,74 €

Display 62



BROCA UNIVERSAL COBALTO MULTI INOX

Multi-STAINLESS Cobalt Universal Drill Bit
Foret universel cobalt Multi INOX

∅	7,5	8	8,5	9	10	11	12	13		
Packs	3	5	3	3	3	2	2	2		
∅	4,25	4,25	4,5	5	5	5,5	6	6	6,5	7
Packs	3	2	5	3	2	5	3	2	5	5
∅	2	2,5	2,5	3	3	3,25	3,5	3,5	4	4
Packs	5	3	2	3	2	5	3	2	3	2

Ref. 4995 - N° Art. 34377: 613,10 €

Display 50



BROCA UNIVERSAL COBALTO MULTI INOX + PREVIOS ROSCADO

Multi-STAINLESS Cobalt Universal Drill Bit + Before Threading
Foret universel cobalt Multi INOX + Pré-Taraudage

∅	8	8,5	9	10	10,2	11	12	13		
Packs	5	3	3	3	2	2	2	2		
∅	4,25	4,5	5	5	5,5	6	6,5	6,8	7	7,5
Packs	5	5	3	2	5	5	5	5	5	3
∅	2	2,5	3	3	3,25	3,3	3,5	4	4	4,2
Packs	5	5	3	2	5	5	5	3	2	3

Ref. 4995 - N° Art. 55633: 719,19 €

Display 52 Mixto PRO



BROCAS MULTI INOX + PARED PRO + MADERA PRO

Multi-Stainless + Concrete Pro + Wood Pro Drill Bits
Forets Multi INOX + Béton Pro + Bois Pro

Ref. 1886	∅	3	4	5	6	7	8	9	10	12	14
	Pcs	5	5	10	10	5	5	3	3	3	3
Ref. 1641	∅	3	3	4	4	5	5	6	6	8	10
	Pcs	3	2	3	2	3	2	3	2	5	5
Ref. 1004	∅	1	2	3	3,5	4	4,5	5	6	8	10
	Pcs	2	2	3	3	5	5	5	5	5	3

Ref. 4995 - N° Art. 68575: 491,16 €

Sets 1021

BROCA UNIVERSAL COBALTO MULTI INOX

Multi-STAINLESS Cobalt Universal Drill Bit
Foret universel cobalt Multi INOX



Set **1462**

6 Pcs

Cont. Ø	Nº Art.	€
2 - 3 - 4 - 5 - 6 - 8 mm	34204	23,71



New!

Set **1459**

29 Pcs

Cont. Ø	Nº Art.	€
1 - 13 x 0,5 mm *	15114	242,42

* + Previos Roscado / Before Threading
Pré-Taroudage (3,3 - 4,2 - 6,8 - 10,2 mm)



Set **1466**

19 Pcs

Cont. Ø	Nº Art.	€
1 - 10 x 0,5 mm	34201	98,64



Set **1456**

25 Pcs

Cont. Ø	Nº Art.	€
1 - 13 x 0,5 mm	34199	215,94



Box-Pallet
1021

5 Sets 1466

Cont. Set	Nº Art.	€
1 - 10 x 0,5 mm	80669	468,57



Box-Pallet
1021

5 Sets 1456

Cont. Set	Nº Art.	€
1 - 13 x 0,5 mm	80684	1.025,71

Ref. **1016**

BROCA MANGO CILÍNDRICO COBALTO

Cobalt Straight Shank Drill Bit
Foret queue cylindrique Cobalt



PROFESSIONAL

HSSE
5% Co

DIN
338 N



Materiales Duros
Hard Materials
Matériaux durs

Aceros
<1300 N/mm²
Steel / Aciers

INOX Ferríticos-Martensíticos
Ferritic-Martensitic Stainless
INOX Ferritiques-Martensitiques

Titanio
Titanium
Titane



Video



D mm	L mm	I mm		Nº Art.	€
0,50	22	6	10	37442	1,92
0,60	27	7	10	37443	2,45
0,70	28	9	10	37444	2,45
0,75	28	9	10	37445	1,75
0,80	30	10	10	37446	1,83
0,90	32	11	10	37447	1,83
1,00	34	12	10	27309	1,41
1,10	36	14	10	20107	1,74
1,20	38	16	10	28861	1,73
1,25	38	16	10	20112	1,67
1,30	38	16	10	20116	1,73
1,40	40	18	10	20125	1,73
1,50	40	18	10	27170	1,36
1,60	43	20	10	20133	1,73
1,70	43	20	10	20142	1,73
1,75	46	22	10	20146	1,67
1,80	46	22	10	20151	1,73
1,90	46	22	10	20155	1,73
2,00	49	24	10	19247	1,40
2,10	49	24	10	20161	1,65
2,20	53	27	10	20166	1,65
2,25	53	27	10	20170	1,58
2,30	53	27	10	20175	1,65
2,40	57	30	10	20184	1,65
2,50	57	30	10	19251	1,28
2,60	57	30	10	20199	1,60
2,65	57	30	10	80109	1,60
2,70	61	33	10	20203	1,60
2,75	61	33	10	19262	1,58
2,80	61	33	10	20209	1,60
2,90	61	33	10	20214	1,60
3,00	61	33	10	19256	1,26

D mm	L mm	I mm		Nº Art.	€
3,05	65	36	10	79847	1,71
3,10	65	36	10	20220	1,53
3,15	65	36	10	79848	1,71
3,20	65	36	10	20224	1,53
3,25	65	36	10	19259	1,53
3,30	65	36	10	20230	1,53
3,40	70	39	10	20235	1,60
3,50	70	39	10	19268	1,52
3,60	70	39	10	20241	1,92
3,70	70	39	10	20245	1,92
3,75	70	39	10	19269	1,79
3,80	75	43	10	20251	1,92
3,90	75	43	10	20256	1,92
4,00	75	43	10	19286	1,61
4,05	75	43	10	18949	2,01
4,10	75	43	10	20265	1,79
4,15	75	43	10	65326	2,01
4,20	75	43	10	20269	1,79
4,25	75	43	10	19271	1,79
4,30	80	47	10	20278	1,92
4,40	80	47	10	20283	1,92
4,50	80	47	10	19274	1,86
4,60	80	47	10	20289	2,13
4,70	80	47	10	20293	2,13
4,75	80	47	10	20298	2,01
4,80	86	52	10	20302	2,13
4,90	86	52	10	20311	2,13
5,00	86	52	10	19277	1,94
5,05	86	52	10	76128	2,59
5,10	86	52	10	20320	2,31
5,15	86	52	10	79849	2,59
5,20	86	52	10	20328	2,31

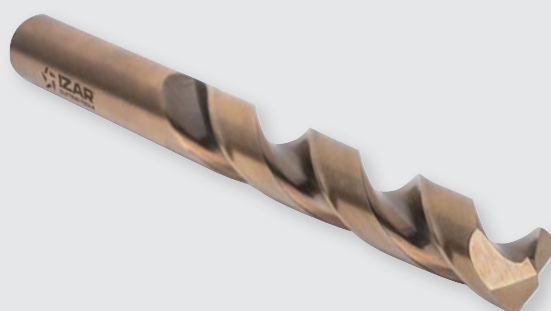





Ref. **1016**

BROCA MANGO CILÍNDRICO COBALTO

Cobalt Straight Shank Drill Bit

Foret queue cylindrique Cobalt

D mm	L mm	I mm		Nº Art.	€	D mm	L mm	I mm		Nº Art.	€
5,25	86	52	10	19280	2,29	9,80	133	87	10	26809	9,47
5,30	86	52	10	20340	2,31	9,90	133	87	10	27121	9,47
5,40	93	57	10	20349	2,31	10,00	133	87	10	27291	6,48
5,50	93	57	10	19290	2,45	10,10	133	87	5	27318	10,87
5,60	93	57	10	20361	2,92	10,20	133	87	5	27541	9,17
5,70	93	57	10	20370	2,92	10,25	133	87	5	27544	11,28
5,75	93	57	10	20379	2,76	10,30	133	87	5	27585	10,87
5,80	93	57	10	20388	2,92	10,40	133	87	5	27682	10,87
5,90	93	57	10	20397	2,92	10,50	133	87	5	27685	9,17
6,00	93	57	10	19301	2,63	10,60	133	87	5	27690	12,65
6,05	101	63	10	79855	3,64	10,70	142	94	5	27693	12,65
6,10	101	63	10	20415	3,24	10,75	142	94	5	27696	13,12
6,15	101	63	10	79856	3,64	10,80	142	94	5	27699	12,65
6,20	101	63	10	20424	3,24	10,90	142	94	5	27702	12,65
6,25	101	63	10	20433	3,06	11,00	142	94	5	27705	10,13
6,30	101	63	10	20442	3,24	11,10	142	94	5	27708	14,39
6,35	101	63	10	79858	3,24	11,20	142	94	5	27711	14,39
6,40	101	63	10	20451	3,24	11,25	142	94	5	27714	14,94
6,45	101	63	10	64140	3,24	11,30	142	94	5	27717	14,39
6,50	101	63	10	27290	3,13	11,40	142	94	5	27720	14,39
6,60	101	63	10	20466	3,89	11,50	142	94	5	19307	12,11
6,70	101	63	10	20475	3,89	11,60	142	94	5	27724	14,88
6,75	109	69	10	20481	3,66	11,70	142	94	5	27727	14,88
6,80	109	69	10	20488	3,66	11,75	142	94	5	27730	15,45
6,90	109	69	10	20493	3,89	11,80	142	94	5	27733	14,88
7,00	109	69	10	19305	3,42	11,90	151	101	5	27736	14,88
7,10	109	69	10	20499	4,95	12,00	151	101	5	19311	12,94
7,20	109	69	10	20503	4,95	12,10	151	101	5	27742	17,26
7,25	109	69	10	20508	4,65	12,20	151	101	5	27745	17,26
7,30	109	69	10	20512	4,95	12,25	151	101	5	19313	17,91
7,40	109	69	10	20517	4,95	12,30	151	101	5	27749	17,26
7,50	109	69	10	19292	3,66	12,40	151	101	5	27752	17,26
7,60	117	75	10	20523	5,98	12,50	151	101	5	27755	15,77
7,70	117	75	10	20527	5,98	12,60	151	101	5	27758	18,01
7,75	117	75	10	20532	5,64	12,70	151	101	5	27761	18,01
7,80	117	75	10	20536	5,98	12,75	151	101	5	19316	18,72
7,90	117	75	10	20541	5,98	12,80	151	101	5	27765	18,01
8,00	117	75	10	20208	4,28	12,90	151	101	5	27768	18,01
8,10	117	75	10	22734	5,70	13,00	151	101	5	27771	16,15
8,20	117	75	10	22737	5,70	13,25	160	108	1	27777	22,31
8,25	117	75	10	22740	5,38	13,50	160	108	1	27774	17,78
8,30	117	75	10	22743	5,70	13,75	160	108	1	27780	22,31
8,40	117	75	10	22746	5,70	14,00	160	108	1	27783	17,59
8,50	117	75	10	19298	4,44	14,25	169	114	1	27786	29,34
8,60	125	81	10	22752	7,26	14,50	169	114	1	27789	24,93
8,70	125	81	10	22755	7,26	14,75	169	114	1	27792	29,34
8,75	125	81	10	22758	6,86	15,00	169	114	1	27795	25,32
8,80	125	81	10	22761	7,26	15,25	178	120	1	27798	40,49
8,90	125	81	10	22764	7,26	15,50	178	120	1	27801	29,31
9,00	125	81	10	20358	5,67	15,75	178	120	1	27804	40,49
9,10	125	81	10	22768	8,05	16,00	178	120	1	27807	30,37
9,20	125	81	10	22771	8,05	16,50	184	125	1	27811	34,70
9,25	125	81	10	22774	7,57	17,00	184	125	1	27814	34,70
9,30	125	81	10	22777	8,05	17,50	191	130	1	27817	38,47
9,40	125	81	10	22780	8,05	18,00	191	130	1	27820	41,88
9,50	125	81	10	20545	5,89	18,50	198	135	1	27823	46,27
9,60	133	87	10	22784	9,47	19,00	198	135	1	27826	46,27
9,70	133	87	10	23567	9,47	19,50	205	140	1	27829	51,29
9,75	133	87	10	26697	8,93	20,00	205	140	1	27832	54,95

Expo
1016

BROCA MANGO CILÍNDRICO COBALTO

Cobalt Straight Shank Drill Bit
Foret queue cylindrique Cobalt



Cuartos / Quarters / Quarts

Ø	1	1,5	2	2,5	3	3,25
Pcs	10	10	40	10	40	10
Ø	3,5	4	4,25	4,5	5	
Pcs	10	40	10	10	40	
Ø	5,5	6	6,5	7		
Pcs	10	40	10	10		
Ø	7,5	8	8,5	9		
Pcs	10	30	10	10		
Ø	9,5	10	11	12	13	
Pcs	10	10	5	5	5	

Nº Art. 57525: **1.137,01 €**

Previos Roscado / Before Threading / Pré-Taraudage

Ø	1	1,5	2	2,5	3	3,3
Pcs	10	10	40	10	40	10
Ø	3,5	4	4,2	4,5	5	
Pcs	10	40	10	10	40	
Ø	5,5	6	6,5	6,8		
Pcs	10	40	10	10		
Ø	7	7,5	8	8,5		
Pcs	10	10	30	10		
Ø	9	9,5	10	10,2	11	12
Pcs	10	10	10	5	5	5

Nº Art. 57978: **1.219,46 €**

Línea 1m
1016

BROCA MANGO CILÍNDRICO COBALTO

Cobalt Straight Shank Drill Bit
Foret queue cylindrique Cobalt



Cuartos / Quarters / Quarts

1,5 10	3	4	5	6 40	7 10	8 30	9 10	10 10	12 5	mm pcs
	2,5 10	3,5 10	4,5 10							
1 10	2 40	3,25 10	4,25 10	5,5 10	6,5 10	7,5 10	8,5 10	9,5 10	11 5	13 5

Nº Art. 71642: **1.137,01 €**

Previos Roscado / Before Threading / Pré-Taraudage

1,5 10	3	4	5	6 40	7 10	8 30	9,5 10	10,2 5	12 5	mm pcs
	2,5 10	3,5 10	4,5 10				9 10			
1 10	2 40	3,3 10	4,2 10	5,5 10	6,5 10	7,5 10	8,5 10	10 10	11 5	13 5

Nº Art. 71643: **1.219,46 €**

Cabinet 1016

BROCA MANGO CILÍNDRICO COBALTO

Cobalt Straight Shank Drill Bit
Foret queue cylindrique Cobalt



220 Pcs

∅	1	1,5	2	2,5	3	3,5	4	4,5
Pcs	10	10	10	10	10	10	10	10
∅	5	5,5	6	6,5	7			
Pcs	10	10	10	10	10			
∅	7,5	8	8,5	9				
Pcs	10	10	10	10				
∅	9,5	10	10,5	11				
Pcs	10	10	5	5				
∅	11,5	12	12,5	13				
Pcs	5	5	5	5				

Nº Art. 55449: **938,29 €**

Ref. **1006**

BROCA MANGO CILÍNDRICO COBALTO

Cobalt Straight Shank Drill Bit
Foret queue cylindrique Cobalt



PROFESSIONAL



HSSE
5% Co

DIN
338 N



Materiales Duros
Hard Materials
Matériaux durs

Aceros
<1300 N/mm²
Steel / Aciers

INOX Ferríticos-Martensíticos
Ferritic-Martensitic Stainless
INOX Ferritiques-Martensitiques

Titanio
Titanium
Titane

D mm	L mm	I mm		Nº Art.	€
1,00	34	12	2	30163	3,31 *
1,50	40	18	2	30164	3,16 *
2,00	49	24	2	18480	3,26 *
2,50	57	30	2	30165	2,97 *
2,80	61	33	2	79615	3,63 *
3,00	61	33	2	18481	2,84 *
3,25	65	36	2	30166	3,43 *
3,30	65	36	2	34035	3,43 *
3,50	70	39	2	30167	3,40 *
3,80	75	43	2	79616	4,35 *
4,00	75	43	2	18483	3,66 *
4,20	75	43	1	34036	2,02
4,25	75	43	1	30168	2,02
4,50	80	47	1	30169	2,09
4,80	86	52	1	79617	2,43
5,00	86	52	1	18484	2,18
5,50	93	57	1	30170	2,78
6,00	93	57	1	18486	2,85
6,50	101	63	1	30171	3,40
6,80	109	69	1	34037	4,01
7,00	109	69	1	18487	3,72
7,50	109	69	1	30172	4,00
8,00	117	75	1	18489	4,67
8,50	117	75	1	30162	4,89
9,00	125	81	1	18490	6,20
9,50	125	81	1	66997	6,24
10,00	133	87	1	18492	6,87
10,20	133	87	1	34038	9,71
10,50	133	87	1	66998	9,71
11,00	142	94	1	30161	10,73
11,50	142	94	1	66999	12,84
12,00	151	101	1	18493	13,74
12,50	151	101	1	67000	16,73
13,00	151	101	1	30160	17,13
14,00	160	108	1	79618	18,66
15,00	169	114	1	79619	26,87

* € = 2 uds.

Línea 1m
1006

BROCA MANGO CILÍNDRICO COBALTO

Cobalt Straight Shank Drill Bit
Foret queue cylindrique Cobalt



∅	1	1,5	2	2,5	3	3,25	3,5	4	4,25	4,5	5	5,5	6	6,5	7	7,5	8	9	10	
Packs	5	5	10	5	10	5	10	10	10	10	10	10	10	10	10	10	10	10	10	10

Ref. 4995 - N° Art. 70936: 604,08 €

Display
13

BROCA MANGO CILÍNDRICO COBALTO

Cobalt Straight Shank Drill Bit
Foret queue cylindrique Cobalt



∅	7,5	8	8,5	9	10	11	12	13		
Packs	5	5	5	5	5	3	3	3		
∅	4	4,25	4,5	5	5	5,5	6	6	6,5	7
Packs	5	10	5	5	5	5	5	5	5	5
∅	1	1,5	2	2,5	3	3	3,25	3,5	3,5	4
Packs	5	5	10	5	5	5	10	5	5	5

Ref. 4995 - N° Art. 22181: 601,73 €

Display
48

BROCA MANGO CILÍNDRICO COBALTO + PREVIOS ROSCADO

Cobalt Straight Shank Drill Bit + Before Threading
Foret Queue Cylindrique Cobalt + Pré-Taraudage



∅	8	8,5	9	10	10,2	11	12	13		
Packs	5	5	5	5	3	3	3	3		
∅	4,25	4,5	5	5	5,5	6	6,5	6,8	7	7,5
Packs	5	5	5	5	5	10	5	5	5	5
∅	1	1,5	2	2,5	3	3,25	3,3	3,5	4	4,2
Packs	5	5	5	5	10	5	5	10	10	5

Ref. 4995 - N° Art. 55621: 634,58 €

Sets 1016

BROCA MANGO CILÍNDRICO COBALTO

Cobalt Straight Shank Drill Bit
Foret queue cylindrique Cobalt



Set **1462**

6 Pcs

Cont. Ø	Nº Art.	€
2 - 3 - 4 - 5 - 6 - 8 mm	30231	13,98



New!

Set **1459**

29 Pcs

Cont. Ø	Nº Art.	€
1 - 13 x 0,5 mm *	15073	150,98

* + Previos Roscado / Before Threading
Pré-Tarudage (3,3 - 4,2 - 6,8 - 10,2 mm)



Set **1466**

19 Pcs

Cont. Ø	Nº Art.	€
1 - 10 x 0,5 mm	25274	58,08

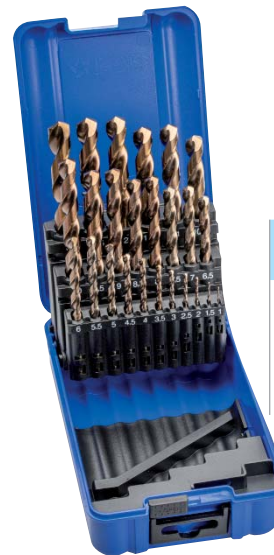

Set **1456**

25 Pcs

Cont. Ø	Nº Art.	€
1 - 13 x 0,5 mm	18370	135,12



Box-Pallet
1016

5 Sets 1466

Cont. Set	Nº Art.	€
1 - 10 x 0,5 mm	80664	275,88



Box-Pallet
1016

5 Sets 1456

Cont. Set	Nº Art.	€
1 - 13 x 0,5 mm	80680	641,84

Display
24

SETS BROCAS MANGO CILINDRICO HSS + HSSE

HSS + HSSE Straight Shank Drill Bit Sets
Jeux Forets Queue Cylindrique HSS + HSSE



HSSE	Ref. 1462 - 1016 Metal Pro 5 Pcs.	Ref. 1466 - 1016 Metal Pro 19 Pcs.	Ref. 1456 - 1016 Metal Pro 25 Pcs.
	Pcs 5	1	1
HSS	Ref. 1462 - 1010 Metal 5 Pcs.	Ref. 1466 - 1010 Metal 19 Pcs.	Ref. 1456 - 1010 Metal 25 Pcs.
	Pcs 5	2	2

Ref. 4995 - N° Art. 22320: 516,71 €

Sets
1016

BROCA MANGO CILÍNDRICO COBALTO

Cobalt Straight Shank Drill Bit
Foret queue cylindrique Cobalt

Set 1407



37 Pcs

Cont. Ø	N° Art.	€
1 - 10 x 0,25 mm	18367	148,61

Set 1409



49 Pcs

Cont. Ø	N° Art.	€
1 - 13 x 0,25 mm	18369	318,46

Set 1405



50 Pcs

Cont. Ø	N° Art.	€
1 - 5,9 x 0,1 mm	10788	103,80

Sets 1016

BROCA MANGO CILÍNDRICO COBALTO

Cobalt Straight Shank Drill Bit
Foret queue cylindrique Cobalt

Set 1408

41 Pcs

Cont. Ø	Nº Art.	€
6 - 10 x 0,1 mm	18366	252,13



Set 1406

91 Pcs

Cont. Ø	Nº Art.	€
1-10 x 0,10 mm	56686	354,78



* Base roja / Red base / Base rouge

Mida y ubique las brocas en un solo movimiento

Gauge and place the drills in one single movement

Measurer et classer les forets en une seule course

- Almacene y trabaje con este juego de 55 brocas para metal
- Manejo fácil para colocar las brocas en los huecos correspondientes
- Posibilidad de colgar en la pared gracias al colgador trasero
- Storage and management in a 55 metalworking drill set
- Easy use to put drills in suitable socket
- Possibility to hang on the wall
- Stockez et travaillez avec ce jeu de 55 forets
- Utilisation facile pour ranger les forets dans le trou correspondant
- Possibilité d'accrocher au mur grâce au crochet arrière

Set 1410

NOVABOX

New!



55 Pcs

Cont. Ø	Nº Art.	€
1 - 13 x 0,5 mm Ø1,0 - 4,0 mm: 3 pcs Ø4,2 - 8,0 mm: 2 pcs Ø8,50 - 13,0 mm: 1 pcs	19537	235,30

Agujeros para:

- Brocas desde 1 a 13 mm x 0,5 mm
- Incluye los siguientes diámetros previos al roscado: Ø2,5 / 3,3 / 4,2 / 5,0 / 6,8 / 8,5 / 10,2 / 12,0 mm para las métricas de roscado M3 / M4 / M5 / M6 / M8 / M10 / M12 / M14

Holes for:

- Drill diameters from 1 to 13 mm x 0,5 mm
- Includes core hole sizes: Ø2,5 / 3,3 / 4,2 / 5,0 / 6,8 / 8,5 / 10,2 / 12,0 mm for threading dimensions M3 / M4 / M5 / M6 / M8 / M10 / M12 / M14

Trous pour:

- Forets de 1 à 13 mm x 0,5 mm
- Inclut les diamètres suivantes pré-taraudage: Ø2,5 / 3,3 / 4,2 / 5,0 / 6,8 / 8,5 / 10,2 / 12,0 mm pour les métriques de taraudage M3 / M4 / M5 / M6 / M8 / M10 / M12 / M14

Sets 1470

170 Pcs

Cont. Ø	Nº Art.	€
1-10 x 0,5 mm Ø 1-8: 10 pcs/Ø Ø 8,5-10: 5 pcs/Ø	10676	456,33



220 Pcs

Cont. Ø	Nº Art.	€
1-13 x 0,5 + 3,3 + 4,2 mm Ø 1-8: 10 pcs/Ø Ø 8,5-13: 5 pcs/Ø	25391	906,06



Ref. **1020**

BROCA MANGO CILÍNDRICO COBALTO INOX

STAINLESS Cobalt Straight Shank Drill Bit

Foret queue cylindrique Cobalt INOX



SPEED MAX

HSSE 5% Co
DIN 338 W
135°
40°
< 5 mm
Chapa Sheets Tôle

INOX Stainless Steel Acier INOX
Aluminio Aluminium



D mm	L mm	I mm	Art.	€	D mm	L mm	I mm	Art.	€	D mm	L mm	I mm	Art.	€		
1,00	34	12	10	14115	2,08	5,60	93	57	10	13987	9,40	125	81	5	14026	10,87
1,25	38	16	10	14116	2,46	5,70	93	57	10	25134	9,50	125	81	5	16316	8,06
1,50	40	18	10	14117	1,97	5,75	93	57	10	16299	9,60	133	87	5	14027	12,95
2,00	49	24	10	21615	1,97	5,80	93	57	10	13989	9,70	133	87	5	14028	12,95
2,10	49	24	10	13961	2,29	5,90	93	57	10	13991	9,75	133	87	5	69935	12,21
2,20	53	27	10	13962	2,29	6,00	93	57	10	16302	9,80	133	87	5	14029	12,95
2,25	53	27	10	21616	2,17	6,10	101	63	10	13993	9,90	133	87	5	14060	12,95
2,30	53	27	10	13963	2,29	6,20	101	63	10	13994	10,00	133	87	5	16318	8,89
2,40	57	30	10	13965	2,29	6,25	101	63	10	21627	10,10	133	87	5	14064	14,78
2,50	57	30	10	21618	1,79	6,30	101	63	10	14002	10,20	133	87	5	14248	11,98
2,60	57	30	10	13966	2,29	6,40	101	63	10	14003	10,25	133	87	5	21634	15,60
2,70	61	33	10	13968	2,29	6,50	101	63	10	16304	10,30	133	87	5	74568	14,78
2,75	61	33	10	21625	2,17	6,60	101	63	10	14004	10,40	133	87	5	74567	14,78
2,80	61	33	10	12964	2,35	6,70	101	63	10	14005	10,50	133	87	5	16320	11,98
2,90	61	33	10	13969	2,35	6,75	109	69	10	21628	10,60	133	87	5	74566	17,43
3,00	61	33	10	16283	1,76	6,80	109	69	10	16306	10,70	142	94	5	74565	17,43
3,10	65	36	10	17970	2,16	6,90	109	69	10	14006	10,75	142	94	5	69934	17,19
3,20	65	36	10	16284	2,16	7,00	109	69	10	16307	10,80	142	94	5	14249	17,43
3,25	65	36	10	16285	2,16	7,10	109	69	10	14007	10,90	142	94	5	74564	17,43
3,30	65	36	10	16286	2,16	7,20	109	69	10	14008	11,00	142	94	5	16321	13,23
3,40	70	39	10	13971	2,35	7,25	109	69	10	21631	11,10	142	94	5	30587	19,28
3,50	70	39	10	16287	2,14	7,30	109	69	10	14009	11,20	142	94	5	14250	19,28
3,60	70	39	10	13972	2,82	7,40	109	69	10	14010	11,25	142	94	5	69932	18,85
3,70	70	39	10	14120	2,82	7,50	109	69	10	16309	11,30	142	94	5	74563	19,28
3,75	70	39	10	16288	2,55	7,60	117	75	10	14011	11,40	142	94	5	74562	19,37
3,80	75	43	10	12507	2,82	7,70	117	75	10	14012	11,50	142	94	5	16322	15,22
3,90	75	43	10	13974	2,82	7,75	117	75	10	69940	11,60	142	94	5	74561	19,95
4,00	75	43	10	16289	2,29	7,80	117	75	10	14013	11,70	142	94	5	74560	19,95
4,10	75	43	10	16290	2,55	7,90	117	75	10	14014	11,75	142	94	5	69931	19,50
4,20	75	43	10	16291	2,55	8,00	117	75	10	16311	11,80	142	94	5	14252	19,95
4,25	75	43	10	16292	2,55	8,10	117	75	5	14015	11,90	151	101	5	74559	19,95
4,30	80	47	10	14122	2,82	8,20	117	75	5	14016	12,00	151	101	5	16323	16,33
4,40	80	47	10	13975	2,82	8,25	117	75	5	21633	12,10	151	101	5	74558	20,95
4,50	80	47	10	16293	2,55	8,30	117	75	5	14017	12,20	151	101	5	14276	20,95
4,60	80	47	10	13979	2,99	8,40	117	75	5	14018	12,25	151	101	5	69929	20,69
4,70	80	47	10	13981	2,99	8,50	117	75	5	16313	12,30	151	101	5	74557	20,95
4,75	80	47	10	16294	2,84	8,60	125	81	5	14019	12,40	151	101	5	74556	20,95
4,80	86	52	10	14123	3,14	8,70	125	81	5	14020	12,50	151	101	5	16324	18,17
4,90	86	52	10	13983	3,14	8,75	125	81	5	69938	12,60	151	101	5	74554	21,86
5,00	86	52	10	16295	2,75	8,80	125	81	5	14021	12,70	151	101	5	74553	21,86
5,10	86	52	10	16296	3,24	8,90	125	81	5	14022	12,75	151	101	5	69928	21,62
5,20	86	52	10	28626	3,39	9,00	125	81	5	16314	12,80	151	101	5	14288	21,86
5,25	86	52	10	16297	3,20	9,10	125	81	5	14023	12,90	151	101	5	74552	21,86
5,30	86	52	10	13984	3,25	9,20	125	81	5	14024	13,00	151	101	5	16325	18,44
5,40	93	57	10	13986	3,25	9,25	125	81	5	69937						
5,50	93	57	10	16298	3,47	9,30	125	81	5	14025	10,87					

Expo
1020

BROCA MANGO CILÍNDRICO COBALTO INOX

STAINLESS Cobalt Straight Shank Drill Bit

Foret queue cylindrique Cobalt INOX



Cuartos / Quarters / Quarts

∅	1	1,5	2	2,5	3	3,25
Pcs	10	10	20	10	20	10
∅	3,5	4	4,25	4,5	5	
Pcs	20	20	10	10	20	
∅	5,5	6		6,5	7	
Pcs	10	20		10	10	
∅	7,5	8		8,5	9	
Pcs	10	10		5	10	
∅	9,5	10	11	12	13	
Pcs	5	5	5	5	5	

Nº Art. 57526: **1.089,11 €**

Previos Roscado / Before Threading / Pré-Tarudage

∅	1	1,5	2	2,5	3	3,3
Pcs	10	10	20	10	20	10
∅	3,5	4	4,2	4,5	5	
Pcs	20	20	10	10	20	
∅	5,5	6		6,5	6,8	
Pcs	10	20		10	10	
∅	7	7,5	8	8,5		
Pcs	10	10	10	5		
∅	9	9,5	10	10,2	11	12
Pcs	10	5	5	5	5	5

Nº Art. 57979: **1.199,45 €**

Línea 1m
1020

BROCA MANGO CILÍNDRICO COBALTO INOX

STAINLESS Cobalt Straight Shank Drill Bit

Foret queue cylindrique Cobalt INOX

Cuartos / Quarters / Quarts

1,5	3	4	5	6	7	8	9	10	12	mm pcs
20	20	20	20	20	10	10	10	5	5	
10	2,5	3,5	4,5	5,5	6,5	7,5	8,5	9,5	11	13
10	10	20	10							

Nº Art. 71644: **1.089,11 €**

Previos Roscado / Before Threading / Pré-Tarudage

1,5	3	4	5	6	7	8	9,5	10,2	12	mm pcs
20	20	20	20	20	10	10	5			
10	2,5	3,5	4,5	5,5	6,8	7,5	8,5	9	10	11
10	10	20	10							
10	2	3,3	4,2	5,5	6,5	7,5	8,5	9,5	10,5	11,5
10	20	10	10	10	10	10	5	5	5	5

Nº Art. 71646: **1.199,45 €**



Cabinet 1020

BROCA MANGO CILÍNDRICO COBALTO INOX

STAINLESS Cobalt Straight Shank Drill Bit

Foret queue cylindrique Cobalt INOX



200 Pcs

∅	1	1,5	2	2,5	3	3,5	4	4,5
Pcs	10	10	10	10	10	10	10	10
∅	5	5,5	6	6,5	7			
Pcs	10	10	10	10	10			
∅	7,5	8	8,5	9				
Pcs	10	10	5	5				
∅	9,5	10	10,5	11				
Pcs	5	5	5	5				
∅	11,5	12	12,5	13				
Pcs	5	5	5	5				

Nº Art. 55446: **1.084,01 €**

Ref. **1005**

BROCA MANGO CILÍNDRICO COBALTO INOX

STAINLESS Cobalt Straight Shank Drill Bit
Foret queue cylindrique Cobalt INOX



SPEED MAX



INOX
Stainless Steel
Acier INOX

Aluminio
Aluminium

D mm	L mm	I mm		Nº Art.	€
1,00	34	12	2	70000	4,67 *
1,50	38	16	2	70001	4,46 *
2,00	49	24	2	24757	4,59 *
2,50	57	30	2	24758	4,18 *
3,00	61	33	2	24759	4,07 *
3,25	65	36	2	24760	4,82 *
3,30	65	36	2	55632	4,82 *
3,50	70	39	2	24761	4,74 *
4,00	75	43	2	24762	5,11 *
4,20	75	43	1	55635	2,85
4,25	75	43	1	24763	2,85
4,50	80	47	1	24764	2,85
5,00	86	52	1	24765	3,05
5,50	93	57	1	24766	3,86
6,00	93	57	1	24767	4,12
6,50	101	63	1	24768	4,65
6,80	109	69	1	55636	5,45
7,00	109	69	1	24769	5,07
7,50	109	69	1	24770	5,40
8,00	117	75	1	24771	6,32
8,50	117	75	1	24772	6,59
9,00	125	81	1	24773	8,43
10,00	133	87	1	24774	9,33
10,20	133	87	1	55638	12,55
11,00	142	94	1	24775	13,88
12,00	151	101	1	24776	17,14
13,00	151	101	1	24777	19,37



* € = 2 uds.



Línea 1m
1005

BROCA MANGO CILÍNDRICO COBALTO INOX

STAINLESS Cobalt Straight Shank Drill Bit

Foret queue cylindrique Cobalt INOX



∅	1	1,5	2	2,5	3	3,25	3,5	4	4,25	4,5	5	5,5	6	6,5	7	7,5	8	9	10
Packs	3	3	5	5	10	5	5	10	5	5	10	5	10	5	5	3	5	3	3

Ref. 4995 - Nº Art. 70940: 480,01 €

Display
16

BROCA MANGO CILÍNDRICO COBALTO INOX

STAINLESS Cobalt Straight Shank Drill Bit

Foret queue cylindrique Cobalt INOX



∅	7,5	8	8,5	9	10	11	12	13		
Packs	5	5	5	5	3	2	2	2		
∅	4,25	4,25	4,5	5	5	5,5	6	6	6,5	7
Packs	3	2	5	5	5	5	3	2	5	5
∅	2	2,5	2,5	3	3	3,25	3,5	3,5	4	4
Packs	5	3	2	5	5	5	3	2	5	5

Ref. 4995 - Nº Art. 22497: 593,42 €

Display
49

BROCA MANGO CILÍNDRICO COBALTO INOX + PREVIOS ROSCADO

STAINLESS Cobalt Straight Shank Drill Bit + Before Threading

Foret queue cylindrique Cobalt INOX + Pré-Tarudage



∅	8	8,5	9	10	10,2	11	12	13		
Packs	5	3	3	3	3	2	2	2		
∅	4,25	4,5	5	5	5,5	6	6,5	6,8	7	7,5
Packs	5	5	5	5	5	10	5	5	5	3
∅	2	2,5	3	3	3,25	3,3	3,5	4	4	4,2
Packs	5	5	5	5	5	5	5	5	5	5

Ref. 4995 - Nº Art. 55629: 676,50 €

Sets 1020

BROCA MANGO CILÍNDRICO COBALTO INOX

STAINLESS Cobalt Straight Shank Drill Bit
Foret queue cylindrique Cobalt INOX



Set **1462**

6 Pcs

Cont. Ø	Nº Art.	€
2 - 3 - 4 - 5 - 6 - 8 mm	25367	19,16



New!

Set **1459**

29 Pcs

Cont. Ø	Nº Art.	€
1 - 13 x 0,5 mm *	15113	195,11

* + Previos Roscado / Before Threading
Pré-Taroudage (3,3 - 4,2 - 6,8 - 10,2 mm)

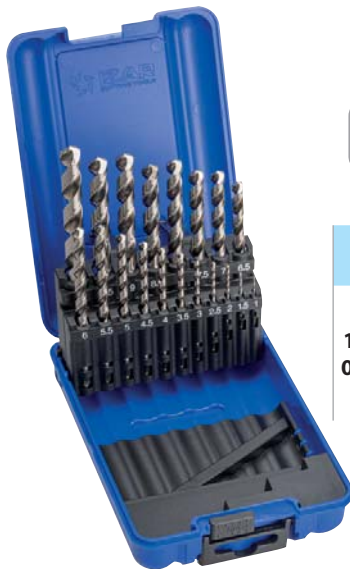

Set **1466**

19 Pcs

Cont. Ø	Nº Art.	€
1 - 10 x 0,5 mm	24636	79,51

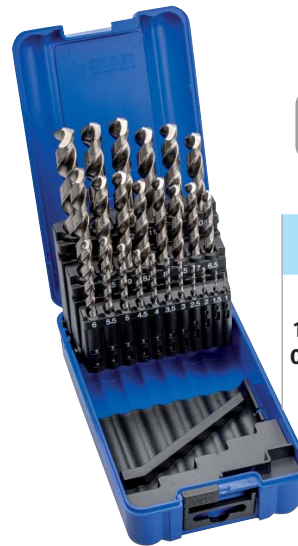

Set **1456**

25 Pcs

Cont. Ø	Nº Art.	€
1 - 13 x 0,5 mm	24638	173,66



Box-Pallet
1020

5 Sets 1466

Cont. Set	Nº Art.	€
1 - 10 x 0,5 mm	80667	377,69



Box-Pallet
1020

5 Sets 1456

Cont. Set	Nº Art.	€
1 - 13 x 0,5 mm	80682	824,90

Ref. **1027**

BROCA MANGO REBAJADO COBALTO

Cobalt Reduced Shank Drill Bit
Foret queue reduite Cobalt



HSSE
5% Co

DIN
338 N



Aceros
<1300 N/mm²
Steel / Aciers

INOX Ferríticos-Martensíticos
Ferritic-Martensitic Stainless
INOX Ferritiques-Martensitiques

Titanio
Titanium
Titane

D mm	d mm	L mm	l mm		N° Art.	€
10,50	10,00	133	87	1	54954	11,90
11,00	10,00	142	94	1	54955	13,15
11,50	10,00	142	94	1	54956	15,75
12,00	10,00	151	101	1	22346	16,84
12,50	10,00	151	101	1	54957	20,49
13,00	10,00	151	101	1	22347	21,61
13,50	12,70	160	108	1	49200	23,13
14,00	12,70	160	108	1	22344	23,55
14,50	12,70	169	114	1	49201	32,43
15,00	12,70	169	114	1	22348	33,88
15,50	12,70	178	120	1	49223	38,10
16,00	12,70	178	120	1	22349	39,08
16,50	12,70	184	125	1	54979	45,09
17,00	12,70	184	125	1	22350	44,66
17,50	12,70	191	130	1	54958	50,01
18,00	12,70	191	130	1	22351	53,93
18,50	12,70	198	135	1	54959	60,17
19,00	12,70	198	135	1	22353	59,55
19,50	12,70	205	140	1	54960	66,71
20,00	12,70	205	140	1	22354	70,71
20,50	12,70	205	145	1	66946	74,45
21,00	12,70	205	145	1	66941	74,45
21,50	12,70	210	150	1	66945	82,13
22,00	12,70	210	150	1	66940	82,13
22,50	12,70	210	150	1	66944	89,85
23,00	12,70	210	150	1	66939	89,85
23,50	12,70	220	160	1	66943	99,15
24,00	12,70	220	160	1	66938	99,15
24,50	12,70	220	160	1	66942	108,11
25,00	12,70	220	160	1	66937	108,11

Línea 1m
1027

BROCA MANGO REBAJADO COBALTO

Cobalt Reduced Shank Drill Bit
Foret queue reduite Cobalt



∅	12	12,5	13	13,5	14	15	15,5	16	16,5	17	17,5	18	18,5	19	19,5	20
Pcs	1	1	1	1	1	1	1	1	1	1	1	1	1	1	1	1

Ref. 4995 - N° Art. 72076: **667,50 €**

Ref. **9015**

BROCA ROMPE BOMBILLOS CERRADURAS

Cylinder Lock Breaker Drill Bit
Foret destructeur de trous de serrure



D mm	d mm	L mm	l mm	Nº Art.	€
6	6	60	34	70727	57,49



- Metal Duro monoblock de última generación
- Punta auto centrante
- Afilado especial IZAR
- Precisión y buen acabado
- Apto para bombillos de latón y acero o bombillos de seguridad.
- Last generation monoblock Solid Carbide
- Autocentering point
- IZAR special Sharpening
- Good Precision and Finishing
- Suitable for brass, steel or security cylinder locks
- Carbure monoblock dernière génération
- Pointe autocentrante
- Affûtage spéciale IZAR
- Précision et bonne qualité de finition
- Conçu pour serrure en laiton et acier ou serrure de sécurité

Ref. **9289**

FRESA MICROGRANO CERRADURAS

Lock Micrograin End Mill
Fraise micrograin serrures

New!

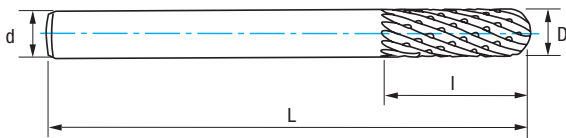

D mm	d mm	L mm	l mm	Nº Art.	€	Nº Art. ALTIN	€
3	6	60	15	53893	18,26	14935	22,10
4	6	60	15	53894	18,83	14941	22,67
6	6	60	18	53895	19,82	14944	25,37

Set
9015

SET CERRAJEROS

Locksmith Set
Jeu serruriers

New!



4 Pcs

Cont.	Nº Art.	€
Ref. 9015: ø 6 mm Ref. 9289: ø 3-4-6 mm	53879	113,79

Ref. **9100**

BROCA MANGO CILÍNDRICO PUNTA METAL DURO

Carbide Tipped Straight Shank Drill Bit
Foret queue cylindrique pointe carbure



MD
HM
Carbure

DIN
338 N



Aceros
<1000 N/mm²
Steel / Aciers

Aceros
<1300 N/mm²
Steel / Aciers



Fundición
Cast Iron
Fonte

Titanio
Titanium
Titane

Cobre
Copper
Cuivre

Duroplásticos
Hard Plastics
Plastiques durs



D mm	L mm	I mm		Nº Art.	€	D mm	L mm	I mm		Nº Art.	€
2,00	49	24	1	71429	15,96	6,30	101	63	1	32692	22,23
2,50	57	30	1	71444	15,96	6,50	101	63	1	71558	22,23
2,70	57	30	1	46916	15,96	6,60	101	63	1	30614	22,24
3,00	61	33	1	71459	15,96	6,80	109	69	1	23893	22,24
3,10	61	33	1	46917	16,44	7,00	109	69	1	71573	22,24
3,20	65	36	1	23058	16,44	7,50	109	69	1	71585	23,12
3,30	65	36	1	26716	16,44	7,80	117	75	1	23914	23,12
3,40	70	39	1	29479	16,44	8,00	117	75	1	71600	23,12
3,50	70	39	1	71474	16,44	8,50	117	75	1	71615	25,22
3,60	70	39	1	52285	16,44	8,60	125	81	1	27007	39,23
4,00	75	43	1	71489	16,44	9,00	125	81	1	71630	25,22
4,10	75	43	1	46918	16,44	9,50	125	81	1	71645	27,55
4,20	75	43	1	22016	16,44	10,00	133	87	1	71660	27,55
4,50	80	47	1	71504	16,86	10,20	133	87	1	27008	35,50
4,60	80	47	1	26963	16,86	10,50	133	87	1	71663	35,50
4,70	80	47	1	17101	16,86	11,00	142	94	1	71666	35,50
4,80	86	52	1	26964	16,86	11,50	142	94	1	71672	40,83
5,00	86	52	1	71516	16,86	12,00	151	101	1	71675	40,83
5,10	86	52	1	23059	17,79	12,50	151	101	1	71681	48,86
5,20	86	52	1	67682	17,79	13,00	151	101	1	71684	48,86
5,50	93	57	1	71531	17,79	14,00	160	108	1	71690	56,85
5,60	93	57	1	32603	18,66	15,00	169	114	1	71696	64,83
5,70	93	57	1	23889	18,66	16,00	178	120	1	71702	74,63
5,80	93	57	1	54039	18,66	17,00	184	125	1	71705	81,72
6,00	93	57	1	71543	18,66	18,00	191	130	1	71711	87,95
6,10	101	63	1	23891	22,23	19,00	198	135	1	71717	109,26
6,20	101	63	1	32691	22,23	20,00	205	140	1	71723	124,36



Ref. **1015**

BROCA MANGO CILÍNDRICO ZIRKONIO

Zirkonio Straight Shank Drill Bit
Foret queue cylindrique Zirkonio

Especial
**Multi
METAL**



ZIRKON

HSS + Zirkonio

DIN 338 N



Tol. D h8



Video



Aceros
<850 N/mm²
Steel / Aciers

Fundición
Cast Iron
Fonte

Aluminio
Aluminium

Angulo punta 130°

- Autocentradora
- Ideal taladro portátil
- Geometría especial diseñada para reducir el esfuerzo de corte

130° Point Angle

- Autocentering
- Ideal Portable Drilling Machine
- Special Geometry designed for reducing cutting effort

Angle Pointe 130°

- Autocentreur
- Perceuse à main
- Géométrie pour réduire l'effort de coupe

Nuevo recubrimiento Zirkonio de última generación por PVD

- Basado en ZRN
- Bajo coeficiente de fricción
- Muy resistente a la corrosión
- Adecuado para materiales no férricos
- Evita la adherencia de material en el filo de corte

Latest generation Zirkonio coating by PVD

- Based on ZRN
- Low Friction Coefficient
- High Corrosion Resistant
- Appropriate for Non-Ferrous Materials
- Built-Up Edge avoided

Nouveau revêtement Zirkonio dernière génération par PVD

- Base ZRN
- Faible coefficient friction
- Résistant à l'usure
- Recommandé pour aciers non ferreux
- Évite l'adhérence sur les filets de coupe

D	L	I	Art.	€
mm	mm	mm	N°	
1,00	34	12	59101	1,61
1,10	36	14	62815	1,88
1,20	38	16	62819	1,88
1,25	38	16	62821	1,88
1,30	38	16	62820	1,88
1,40	40	18	62821	1,88
1,50	40	18	59103	1,46
1,60	43	20	62822	1,88
1,70	43	20	62823	1,88
1,75	46	22	68274	1,69
1,80	46	22	62824	1,88
1,90	46	22	62826	1,88
2,00	49	24	59100	1,52
2,10	49	24	62827	1,77
2,20	53	27	62828	1,77
2,25	53	27	68363	1,62
2,30	53	27	62829	1,77
2,40	57	30	62830	1,77
2,50	57	30	59104	1,37
2,60	57	30	62831	1,72
2,70	61	33	62832	1,72
2,75	61	33	68364	1,46
2,80	61	33	62833	1,72
2,90	61	33	62834	1,72
3,00	61	33	59115	1,34
3,10	65	36	62835	1,65
3,20	65	36	59118	1,65
3,25	65	36	59121	1,65
3,30	65	36	59124	1,65
3,40	70	39	62836	1,72
3,50	70	39	59127	1,62
3,60	70	39	62837	2,07

D	L	I	Art.	€
mm	mm	mm	N°	
3,70	70	39	62838	2,07
3,75	70	39	68365	1,80
3,80	75	43	62839	2,07
3,90	75	43	62841	2,07
4,00	75	43	59131	1,74
4,10	75	43	62842	1,83
4,20	75	43	59133	1,83
4,25	75	43	59134	1,83
4,30	80	47	62843	1,95
4,40	80	47	62844	1,95
4,50	80	47	59137	1,89
4,60	80	47	62845	2,17
4,70	80	47	62846	2,17
4,75	80	47	68350	1,94
4,80	86	52	62847	2,17
4,90	86	52	62848	2,17
5,00	86	52	58831	1,97
5,10	86	52	62849	2,35
5,20	86	52	59139	2,35
5,25	86	52	68366	2,26
5,30	86	52	62850	2,35
5,40	93	57	62851	2,35
5,50	93	57	59140	2,50
5,60	93	57	62852	2,99
5,70	93	57	62853	2,99
5,75	93	57	68367	2,90
5,80	93	57	62854	2,99
5,90	93	57	62855	2,99
6,00	93	57	59145	2,66
6,10	101	63	62856	3,31
6,20	101	63	62857	3,31
6,25	101	63	68368	3,08

D	L	I	Art.	€
mm	mm	mm	N°	
6,30	101	63	62858	3,31
6,40	101	63	62859	3,31
6,50	101	63	59148	3,20
6,60	101	63	62860	3,96
6,70	101	63	62861	3,96
6,75	109	69	68369	2,99
6,80	109	69	59149	3,72
6,90	109	69	62862	3,96
7,00	109	69	59151	3,49
7,10	109	69	62863	5,05
7,20	109	69	62864	5,05
7,25	109	69	68370	4,13
7,30	109	69	62865	5,05
7,40	109	69	62866	5,05
7,50	109	69	59155	3,72
7,60	117	75	62867	6,10
7,70	117	75	62868	6,10
7,75	117	75	68371	4,71
7,80	117	75	62869	6,10
7,90	117	75	62870	6,10
8,00	117	75	59157	4,36
8,10	117	75	62871	5,82
8,20	117	75	62872	5,82
8,25	117	75	68372	4,38
8,30	117	75	62873	5,82
8,40	117	75	62874	5,82
8,50	117	75	59158	4,55
8,60	125	81	62875	7,39
8,70	125	81	62876	7,39
8,75	125	81	68373	5,65
8,80	125	81	62877	7,39
8,90	125	81	62878	7,39

Ref. **1015**

BROCA MANGO CILÍNDRICO ZIRKONIO

Zirkonio Straight Shank Drill Bit
Foret queue cylindrique Zirkonio



D mm	L mm	I mm		Nº Art.	€
9,00	125	81	5	59161	5,80
9,10	125	81	5	62879	8,20
9,20	125	81	5	62880	8,20
9,25	125	81	5	68374	6,32
9,30	125	81	5	62881	8,20
9,40	125	81	5	62882	8,20
9,50	125	81	5	59163	6,00
9,60	133	87	5	62883	9,65
9,70	133	87	5	62884	9,65
9,75	133	87	5	68375	7,05
9,80	133	87	5	62886	9,65
9,90	133	87	5	62887	9,65
10,00	133	87	5	59164	6,59
10,10	133	87	5	62888	11,09
10,20	133	87	5	59166	9,35
10,30	133	87	5	62889	11,09

D mm	L mm	I mm		Nº Art.	€
10,40	133	87	5	62890	11,09
10,50	133	87	5	59167	9,35
10,60	133	87	5	62892	12,89
10,70	142	94	5	62893	12,89
10,80	142	94	5	62895	12,89
10,90	172	94	5	62896	12,89
11,00	142	94	5	59170	10,34
11,10	142	94	5	62898	14,66
11,20	142	94	5	62900	14,66
11,30	142	94	5	62902	14,66
11,40	142	94	5	62904	14,66
11,50	142	94	5	59172	12,35
11,60	172	94	5	62905	15,19
11,70	142	94	5	62907	15,19
11,80	142	94	5	62908	15,19
11,90	151	101	5	62909	15,19

D mm	L mm	I mm		Nº Art.	€
12,00	151	101	5	59173	13,22
12,10	151	101	5	62910	17,60
12,20	151	101	5	62918	17,60
12,30	151	101	5	62921	17,60
12,40	151	101	5	62923	17,60
12,50	151	101	5	59176	16,08
12,60	151	101	5	62927	18,37
12,70	151	101	5	62930	18,37
12,80	151	101	5	62932	18,37
12,90	151	101	5	62934	18,37
13,00	151	101	5	59179	16,46
New! 13,50	160	108	1	25147	22,50
New! 14,00	160	108	1	25154	24,13
New! 14,50	169	114	1	25155	25,94
New! 15,00	169	114	1	25156	26,26
New! 16,00	178	120	1	25157	32,00

Expo
1015

BROCA MANGO CILÍNDRICO ZIRKONIO

Zirkonio Straight Shank Drill Bit
Foret queue cylindrique Zirkonio

Cuartos / Quarters / Quarts

ø	1	1,5	2	2,5	3	3,25
Pcs	10	10	30	10	50	10
ø	3,5	4	4,25	4,5	5	
Pcs	10	50	10	10	40	
ø	5,5	6	6,5	7		
Pcs	10	50	10	10		
ø	7,5	8	8,5	9		
Pcs	10	20	10	10		
ø	9,5	10	11	12	13	
Pcs	5	10	5	5	5	

Nº Art. 15999: **1.141,17 €**

Previos Roscado / Before Threading / Pré-Tarudage

ø	1	1,5	2	2,5	3	3,3
Pcs	10	10	30	10	50	10
ø	3,5	4	4,2	4,5	5	
Pcs	10	50	10	10	40	
ø	5,5	6	6,5	6,8		
Pcs	10	50	10	10		
ø	7	7,5	8	8,5		
Pcs	10	10	20	10		
ø	9	9,5	10	10,2	11	12
Pcs	10	5	10	5	5	5

Nº Art. 16001: **1.225,10 €**



Línea 1m 1015

BROCA MANGO CILÍNDRICO ZIRKONIO

Zirkonio Straight Shank Drill Bit
Foret queue cylindrique Zirkonio

Cuartos / Quarters / Quarts

1,5 10	3	4	5	6	7	8	9	10	12	mm pcs
	50	50	40							
1 10	2,5	3,5	4,5	5,5	6,5	7,5	8,5	9,5	11	13
	10	10	10							
	2	3,25	4,25							
	30	10	10							

Nº Art. 71396: **1.141,17 €**

Previos Roscado / Before Threading / Pré-Taraudage

1,5 10	3	4	5	6	7	8	9,5	10,2	12	mm pcs
	50	50	40		10		20			
1 10	2,5	3,5	4,5	5,5	6,8	7,5	9	10	11	13
	10	10	10		10		10			
	2	3,3	4,2		6,5		8,5			
	30	10	10		10		10			

Nº Art. 71638: **1.225,10 €**



Cabinet 1015

BROCA MANGO CILÍNDRICO ZIRKONIO

Zirkonio Straight Shank Drill Bit
Foret queue cylindrique Zirkonio



200 Pcs

Ø	1	1,5	2	2,5	3	3,5	4	4,5
Pcs	10	10	10	10	10	10	10	10
Ø	5		5,5		6	6,5		7
Pcs	10		10		10	10		10
Ø	7,5		8		8,5		9	
Pcs	10		10		5		5	
Ø	9,5		10		10,5		11	
Pcs	5		5		5		5	
Ø	11,5		12		12,5		13	
Pcs	5		5		5		5	

Nº Art. 14229: **848,08 €**

Ref. **1065**

BROCA MANGO CILÍNDRICO ZIRKONIO

Zirkonio Straight Shank Drill Bit
Foret queue cylindrique Zirkonio

New!



Tol. D
h8

Aceros
<850 N/mm²
Steel / Aciers

Fundición
Cast Iron
Fonte

Aluminio
Aluminium



D mm	L mm	I mm		Nº Art.	€
1,00	34	12	2	14509	3,72 *
1,50	40	18	2	14547	3,34 *
2,00	49	24	2	14592	3,48 *
2,50	57	30	2	14640	3,15 *
3,00	61	33	2	14682	3,08 *
3,25	65	36	2	14694	3,79 *
3,30	65	36	2	14700	3,79 *
3,50	70	39	2	14731	3,74 *
4,00	75	43	2	14734	4,00 *
4,20	75	43	1	14743	2,11
4,25	75	43	1	14749	2,11
4,50	80	47	1	14757	2,16
5,00	86	52	1	14758	2,28
5,50	93	57	1	14772	2,88
6,00	93	57	1	14776	3,05
6,50	101	63	1	14784	3,52

New!

New!

D mm	L mm	I mm		Nº Art.	€
6,80	109	69	1	25971	4,09
7,00	109	69	1	14787	3,84
7,50	109	69	1	14794	4,09
8,00	117	75	1	14796	4,79
8,50	117	75	1	14799	4,99
9,00	125	81	1	14805	6,38
9,50	125	81	1	14809	6,59
10,00	133	87	1	14811	6,92
10,20	133	87	1	14812	9,82
10,50	133	87	1	14814	9,82
11,00	142	94	1	14818	10,84
11,50	142	94	1	14821	12,96
12,00	151	101	1	14823	13,88
12,50	151	101	1	40206	16,88
13,00	151	101	1	14824	17,29

* € = 2 uds.



Sets 1015

BROCA MANGO CILÍNDRICO ZIRKONIO

Zirkonio Straight Shank Drill Bit
Foret queue cylindrique Zirkonio



Set **1462**

6 Pcs

Cont. Ø	Nº Art.	€
2 - 3 - 4 - 5 - 6 - 8 mm	59236	14,45



New!

Set **1459**

29 Pcs

Cont. Ø	Nº Art.	€
1 - 13 x 0,5 mm *	15115	154,59

* + Previos Roscado Before Threading
Pré-Taroudage (3,3 - 4,2 - 6,8 - 10,2 mm)



Set **1406**

91 Pcs

Cont. Ø	Nº Art.	€
1-10 x 0,10 mm	66483	364,10

* Base roja / Red base / Base rouge



Set **1466**

19 Pcs

Cont. Ø	Nº Art.	€
1 - 10 x 0,5 mm	59234	59,76

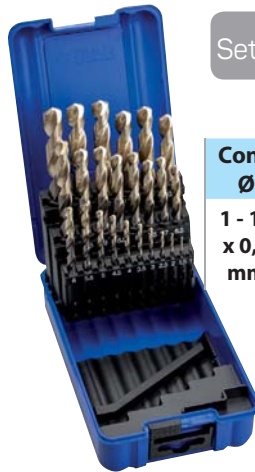

Set **1456**

25 Pcs

Cont. Ø	Nº Art.	€
1 - 13 x 0,5 mm	59235	138,33

Set **1410**

NOVABOX

New!



55 Pcs

Cont. Ø	Nº Art.	€
1 - 13 x 0,5 mm Ø1,0 - 4,0 mm: 3 pcs Ø4,2 - 8,0 mm: 2 pcs Ø8,50 - 13,0 mm: 1 pcs	28360	241,82



Box-Pallet
1015

5 Sets 1466

Cont. Set	Nº Art.	€
1 - 10 x 0,5 mm	80662	283,89



Box-Pallet
1015

5 Sets 1456

Cont. Set	Nº Art.	€
1 - 13 x 0,5 mm	80678	657,05

Ref. **1010**

BROCA MANGO CILÍNDRICO HSS

HSS Straight Shank Drill Bit
Foret queue cylindrique HSS



CLASSIQUE



HSS + TIN	DIN 338 N			Usos General General Purpose Utilisation générale
------------------	-----------	--	--	--

Aceros <850 N/mm ² Steel / Aciers	Fundición Cast Iron Fonte	Aluminio Aluminium
---	--	------------------------------

D mm	L mm	I mm		Nº Art. HSS	€	Nº Art. TIN	€
0,30	19	3	10	17996	1,96		
0,35	19	4	10	17999	2,02		
0,40	20	5	10	18002	1,96		
0,45	20	5	10	18005	1,96		
0,50	22	6	10	18008	1,38		
0,55	24	7	10	18011	1,74		
0,60	24	7	10	18014	1,74		
0,65	26	8	10	18017	1,74		
0,70	28	9	10	18020	1,74		
0,75	28	9	10	18023	1,27		
0,80	30	10	10	18026	1,30		
0,85	30	10	10	18029	1,30		
0,90	32	11	10	18032	1,30		
0,95	32	11	10	18035	1,30		
1,00	34	12	10	10001	1,01	18305	2,08
New! 1,05	34	12	10	18038	1,12	53352	2,10
1,10	36	14	10	10004	1,12	15056	2,10
1,15	36	14	10	18041	1,12		
1,20	38	16	10	10007	1,12	18308	2,10
1,25	38	16	10	10010	0,89	27087	1,95
1,30	38	16	10	10013	0,99	18311	2,02
1,35	40	18	10	18050	0,99		
1,40	40	18	10	10016	0,99	27337	2,02
1,45	40	18	10	18053	0,99		
1,50	40	18	10	10019	0,77	18314	1,78
1,55	43	20	10	18059	0,95		
1,60	43	20	10	10022	0,95	18317	1,99
1,65	43	20	10	18062	0,95		
1,70	43	20	10	10025	0,95	18320	1,99
1,75	46	22	10	10028	0,85	18323	1,94
1,80	46	22	10	10031	0,85	18326	1,90
New! 1,85	46	22	10	18068	0,85	77801	1,90
1,90	46	22	10	10034	0,85	18329	1,90
1,95	49	24	10	18071	0,85		
2,00	49	24	10	10037	0,73	18332	1,78
2,05	49	24	10	18074	0,75		
2,10	49	24	10	10040	0,75	18335	1,71
2,15	53	27	10	18077	0,75		

D mm	L mm	I mm		Nº Art. HSS	€	Nº Art. TIN	€
2,20	53	27	10	10043	0,75	18338	1,71
2,25	53	27	10	10046	0,70	18341	1,66
2,30	53	27	10	10049	0,88	18344	1,83
2,35	53	27	10	18080	0,88		
2,40	57	30	10	10052	0,88	18347	1,83
2,45	57	30	10	18083	0,88		
2,50	57	30	10	10055	0,73	18350	1,72
2,55	57	30	10	18086	0,90		
2,60	57	30	10	10058	0,90	18353	1,84
2,65	57	30	10	18089	0,90		
2,70	61	33	10	10061	0,90	27166	1,84
2,75	61	33	10	10064	0,77	18356	1,78
2,80	61	33	10	10067	0,90	18359	1,84
2,85	61	33	10	18092	0,90		
2,90	61	33	10	10070	0,90	27088	1,84
2,95	61	33	10	18095	0,90		
3,00	61	33	10	10073	0,66	18362	1,61
3,05	65	36	10	18098	0,87	17358	2,09
3,10	65	36	10	10076	0,77	18365	2,05
3,15	65	36	10	27343	0,87	29078	2,09
3,20	65	36	10	10079	0,77	18368	2,05
3,25	65	36	10	10082	0,77	18371	2,05
3,30	65	36	10	10085	0,77	18374	2,05
3,35	65	36	10	27345	0,99		
3,40	70	39	10	10088	1,00	27322	2,19
3,45	70	39	10	27346	1,00	21777	2,19
3,50	70	39	10	10091	0,75	18377	2,01
3,55	70	39	10	18101	1,03		
3,60	70	39	10	10094	1,03	27323	2,22
3,65	70	39	10	18104	1,03		
3,70	70	39	10	10097	1,03	18380	2,22
3,75	70	39	10	10100	0,88	18383	2,14
3,80	75	43	10	10103	1,06	18386	2,25
3,85	75	43	10	18107	1,06	79546	2,25
3,90	75	43	10	10106	1,06	27165	2,25
3,95	75	43	10	18110	1,06		
4,00	75	43	10	10109	0,86	18389	2,11
4,05	75	43	10	27349	1,06		

Ref. 1010

BROCA MANGO CILÍNDRICO HSS

HSS Straight Shank Drill Bit
Foret queue cylindrique HSS

D mm	L mm	I mm		N° Art. HSS	€	N° Art. TIN	€
4,10	75	43	10	10112	0,95	18392	2,19
4,15	75	43	10	27350	1,06		
4,20	75	43	10	10115	0,95	18395	2,19
4,25	75	43	10	10118	0,95	18398	2,19
4,30	80	47	10	10121	1,26	18401	2,43
4,35	80	47	10	18113	1,26		
4,40	80	47	10	10124	1,26	18404	2,43
4,45	80	47	10	18116	1,26		
4,50	80	47	10	10127	0,99	18407	2,23
4,55	80	47	10	27288	1,27		
4,60	80	47	10	10130	1,27	18410	2,45
4,65	80	47	10	27352	1,27		
4,70	80	47	10	10133	1,27	18413	2,45
4,75	80	47	10	10136	1,12	18416	2,35
4,80	86	52	10	10139	1,42	18419	2,59
4,85	86	52	10	18119	1,39		
4,90	86	52	10	10142	1,39	18422	2,55
4,95	86	52	10	18122	1,39		
5,00	86	52	10	10145	1,05	18425	2,27
5,05	86	52	10	18125	1,43	21749	2,58
5,10	86	52	10	10148	1,43	18428	2,58
5,15	86	52	10	27330	1,43		
5,20	86	52	10	10151	1,43	18431	2,58
5,25	86	52	10	10154	1,34	18434	2,57
5,30	86	52	10	10157	1,77	18437	2,92
5,35	93	57	10	18131	1,77		
5,40	93	57	10	10160	1,77	27292	2,92
5,45	93	57	10	27354	1,77		
5,50	93	57	10	10163	1,40	18440	2,63
5,55	93	57	10	27356	1,89	65683	3,04
5,60	93	57	10	10166	1,89	18443	3,04
5,65	93	57	10	18134	1,89		
5,70	93	57	10	10169	1,89	18446	3,04
5,75	93	57	10	10172	1,81	18449	3,03
5,80	93	57	10	10175	1,77	18452	2,92
5,85	93	57	10	27357	1,77		
5,90	93	57	10	10178	1,77	18455	2,92
5,95	93	57	10	27358	1,77		
6,00	93	57	10	10181	1,45	18458	2,65
6,05	101	63	10	27359	2,04	17594	5,26
6,10	101	63	10	10184	2,04	18461	5,26
6,15	101	63	10	27360	2,04	79817	5,26
6,20	101	63	10	10187	2,04	18464	5,26
6,25	101	63	10	10190	1,94	18467	5,26
6,30	101	63	10	10193	2,15	27324	5,34
6,35	101	63	10	27361	2,15		
6,40	101	63	10	10196	2,22	18470	5,43
6,45	101	63	10	18137	2,15		
6,50	101	63	10	10199	1,67	18473	5,02
6,55	101	63	10	18140	2,69		
6,60	101	63	10	10202	2,69	18476	5,86
6,65	101	63	10	27362	2,69		
6,70	101	63	10	10205	2,69	27333	5,86
6,75	109	69	10	10208	2,02	18479	5,36
6,80	109	69	10	10211	2,02	18482	5,36
6,85	109	69	10	18143	2,97		
6,90	109	69	10	10214	2,97	18485	6,12
6,95	109	69	10	27316	2,97		
7,00	109	69	10	10217	2,02	18488	5,36
7,05	109	69	10	27363	3,13	79818	6,31



D mm	L mm	I mm		N° Art. HSS	€	N° Art. TIN	€
7,10	109	69	10	10220	3,13	18491	6,31
7,15	109	69	10	27364	3,13		
7,20	109	69	10	10223	3,13	18494	6,31
7,25	109	69	10	10226	2,58	18497	5,88
7,30	109	69	10	10229	3,13	18500	6,31
7,35	109	69	10	27365	3,13		
7,40	109	69	10	10232	3,13	27150	6,31
7,45	109	69	10	27366	3,22		
7,50	109	69	10	10235	2,14	18503	5,48
7,55	117	75	10	27369	3,72		
7,60	117	75	10	10238	3,72	27313	6,91
7,65	117	75	10	27368	3,72		
7,70	117	75	10	10241	3,72	18506	6,91
7,75	117	75	10	10244	2,88	27272	6,25
7,80	117	75	10	10247	3,76	18509	6,93
7,85	117	75	10	27370	3,76		
7,90	117	75	10	10250	3,76	18512	6,93
7,95	117	75	10	27372	3,76		
8,00	117	75	10	10253	2,45	18515	5,77
8,05	117	75	10	27373	3,84	39695	7,58
8,10	117	75	10	10256	3,84	26675	7,58
8,15	117	75	10	27374	3,84		
8,20	117	75	10	10259	3,84	26678	7,58
8,25	117	75	10	10262	2,88	18518	6,83
8,30	117	75	10	10265	4,00	27311	7,74
8,35	117	75	10	27376	4,00		
8,40	117	75	10	10268	4,00	26681	7,74
8,45	117	75	10	27377	4,00		
8,50	117	75	10	10271	2,65	18521	6,53
8,55	125	81	10	27378	5,02		
8,60	125	81	10	10274	5,02	18524	8,71
8,65	125	81	10	27379	5,02		
8,70	125	81	10	10277	5,02	18527	8,71
8,75	125	81	10	10280	3,86	18530	7,75
8,80	125	81	10	10283	5,04	18533	8,72
8,85	125	81	10	27381	5,04		
8,90	125	81	10	10286	5,04	18536	8,72
8,95	125	81	10	27383	5,04		
9,00	125	81	10	10289	3,24	18539	7,06
9,05	125	81	10	27382	5,07		
9,10	125	81	10	10292	5,07	26684	8,76
9,15	125	81	10	27385	5,07		
9,20	125	81	10	10295	5,07	27553	8,76
9,25	125	81	10	10298	3,89	27273	7,79
9,30	125	81	10	10301	4,75	18542	8,45
New! 9,35	125	81	10	27556	5,23		
9,40	125	81	10	10304	4,75	27149	8,45
9,45	125	81	10	27387	4,75		
9,50	125	81	10	10307	3,52	18545	7,35
9,55	133	87	10	27389	6,05		
9,60	133	87	10	10310	6,05	26687	9,70
9,65	133	87	10	27390	6,05		
9,70	133	87	10	10313	6,05	27151	9,70
9,75	133	87	10	10316	4,39	18548	8,27
9,80	133	87	10	10319	5,95	18551	9,60
9,85	133	87	10	27391	5,95		
9,90	133	87	10	10322	5,95	18554	9,60
9,95	133	87	10	27393	5,95		
10,00	133	87	10	10325	3,78	18557	7,62
10,10	133	87	5	10328	5,07	29149	13,27



Ref. **1010**

BROCA MANGO CILÍNDRICO HSS

HSS Straight Shank Drill Bit
Foret queue cylindrique HSS

D mm	L mm	I mm		Nº Art. HSS	€	Nº Art. TIN	€	D mm	L mm	I mm		Nº Art. HSS	€	Nº Art. TIN	€
10,20	133	87	5	10331	4,73	18560	12,92	13,80	160	108	1	18176	15,20	24664	25,66
10,25	133	87	5	10334	5,28	27274	13,48	13,90	160	108	1	10451	15,20	68188	25,66
10,30	133	87	5	10337	5,91	29151	13,78	14,00	160	108	1	10454	11,31	29007	21,79
10,40	133	87	5	10340	5,91			14,10	169	114	1	18179	16,20		
10,50	133	87	5	10343	4,73	18563	12,62	14,20	169	114	1	18185	16,20		
10,60	133	87	5	10346	6,52	29154	14,00	14,25	169	114	1	10457	13,27	29194	23,64
10,70	142	94	5	10349	6,52			14,30	169	114	1	18188	16,50		
10,75	142	94	5	10352	6,12	27277	13,94	14,40	169	114	1	18191	16,50		
10,80	142	94	5	10355	7,23	29157	14,69	14,50	169	114	1	10460	12,20	29198	22,59
10,90	142	94	5	10358	7,23			14,60	169	114	1	18194	16,80		
11,00	142	94	5	10361	5,51	18566	13,36	14,70	169	114	1	18197	16,80		
11,10	142	94	5	10364	7,35			14,75	169	114	1	10463	13,27	29202	23,64
11,20	142	94	5	10367	7,35			14,80	169	114	1	18200	16,20		
11,25	142	94	5	10370	6,24	26801	14,05	14,90	169	114	1	18203	16,20		
11,30	142	94	5	10373	7,23			15,00	169	114	1	10466	12,33	29205	22,76
11,40	142	94	5	10376	7,23	27450	15,06	15,20	178	120	1	18209	21,26		
11,50	142	94	5	10379	5,89	18569	13,72	15,25	178	120	1	10469	18,10	29209	28,26
11,60	142	94	5	10382	7,23			15,50	178	120	1	10472	14,43	29213	24,77
11,70	142	94	5	10385	7,23			15,60	178	120	1	18218	24,88		
11,75	142	94	5	10388	6,24	27275	14,05	15,70	178	120	1	18221	24,88		
11,80	142	94	5	10391	7,90	29166	15,69	15,75	178	120	1	10475	18,34		
11,90	151	101	5	10394	7,90	29167	15,69	15,80	178	120	1	18224	23,22		
12,00	151	101	5	10397	6,55	18572	14,36	15,90	178	120	1	18227	23,22		
12,10	151	101	5	10400	9,22	29169	18,57	16,00	178	120	1	10478	15,02	29220	25,32
12,20	151	101	5	10403	9,22			16,20	184	125	1	27289	31,79		
12,25	151	101	5	10406	8,13	18578	17,92	16,25	184	125	1	10481	27,03		
12,30	151	101	5	10409	8,68			16,50	184	125	1	10484	17,48	12861	27,01
12,40	151	101	5	10412	8,68			16,75	184	125	1	10487	28,25	19368	37,77
12,50	151	101	5	10415	7,21	18581	17,01	16,80	184	125	1	27676	42,70	19369	52,24
12,60	151	101	5	10418	9,00			17,00	184	125	1	10490	17,48	12866	27,02
12,70	151	101	5	10421	9,00			17,25	191	130	1	10493	29,33		
12,75	151	101	5	10424	8,01	27276	17,80	17,50	191	130	1	10496	20,09	12862	29,62
12,80	151	101	5	10427	10,04			17,75	191	130	1	10499	32,48		
12,90	151	101	5	10430	10,04			18,00	191	130	1	10502	21,24	29236	29,89
13,00	151	101	5	10433	7,46	18584	17,28	18,25	198	135	1	10505	31,85		
13,10	151	101	1	10436	10,26			18,50	198	135	1	10508	23,59		
13,20	151	101	1	18164	10,26			18,75	198	135	1	10511	32,76		
13,25	160	108	1	10439	11,71	29180	22,16	19,00	198	135	1	10514	23,59	14065	33,66
13,30	160	108	1	18167	15,89			19,25	205	140	1	10517	42,87		
13,40	160	108	1	18170	15,89			19,50	205	140	1	10520	25,29		
13,50	160	108	1	10442	10,56	29184	21,05	19,75	205	140	1	10523	41,58		
13,60	160	108	1	18173	15,89			(New!) 20,00	205	140	1	10526	28,82	14076	37,48
13,70	160	108	1	10445	15,89										
13,75	160	108	1	10448	11,87	16497	22,34								

Ref. **1050**



Extra-Corta / Stub / Extra-courte

Pag 69

Ref. **1030**



Larga / Long / Longue

Pag 70

Ref. **1040**



Extra Larga / Extra Long / Extra-longue

Pag 74

Expo
1010

BROCA MANGO CILÍNDRICO HSS

HSS Straight Shank Drill Bit
Foret queue cylindrique HSS



Cuartos / Quarters / Quarts

∅	1	1,5	2	2,5	3	3,25
Pcs	30	20	40	30	80	20
∅	3,5	4	4,25	4,5	5	
Pcs	20	60	10	20	80	
∅	5,5	6	6,5	7		
Pcs	10	60	20	20		
∅	7,5	8	8,5	9		
Pcs	10	40	10	10		
∅	9,5	10	11	12	13	
Pcs	10	30	15	20	10	

Nº Art. 57523: **1.134,98 €**

Previos Roscado / Before Threading / Pré-Tarudage

∅	1	1,5	2	2,5	3	3,3
Pcs	30	20	40	30	80	20
∅	3,5	4	4,2	4,5	5	
Pcs	20	60	10	20	80	
∅	5,5	6	6,5	6,8		
Pcs	10	60	20	10		
∅	7	7,5	8	8,5		
Pcs	20	10	40	10		
∅	9	9,5	10	10,2	11	12
Pcs	10	10	30	10	15	20
						13
						10

Nº Art. 57975: **1.202,53 €**

Línea 1m
1010

BROCA MANGO CILÍNDRICO HSS

HSS Straight Shank Drill Bit
Foret queue cylindrique HSS



Cuartos / Quarters / Quarts

1,5 20	3	4	5	6	7	8	9	10	12	mm pcs
	80	60	80							
1 30	2,5	3,5	4,5	5,5	6,5	7,5	8,5	9,5	11	13
	30	20	20							

Nº Art. 70965: **1.134,98 €**

Previos Roscado / Before Threading / Pré-Tarudage

1,5 20	3	4	5	6	7	8	9,5	10,2	12	mm pcs
	80	60	80				60			
1 30	2,5	3,5	4,5	5,5	6,8	7,5	9	10	11	13
	30	20	20				10			
	2	3,3	4,2	5,5	6,5	7,5	8,5	10	11	13
	40	20	10	10	20	10	10	30	15	10

Nº Art. 70999: **1.202,53 €**

Cabinet 1010

BROCA MANGO CILÍNDRICO HSS

HSS Straight Shank Drill Bit
Foret queue cylindrique HSS

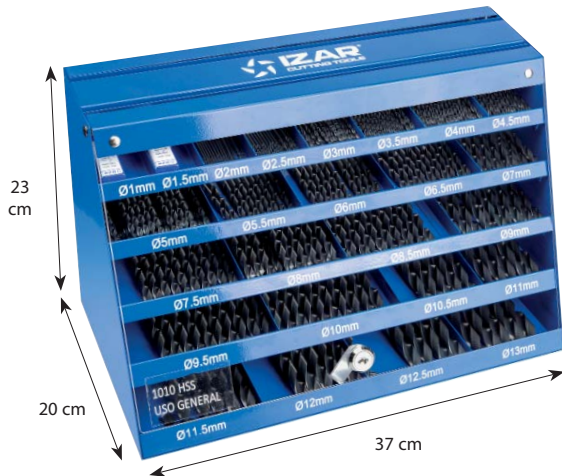

400 Pcs

∅	1	1,5	2	2,5	3	3,5	4	4,5
Pcs	10	10	20	20	50	30	40	20
∅	5	5,5	6	6,5	7			
Pcs	40	10	30	10	10			
∅	7,5	8	8,5	9				
Pcs	10	20	10	10				
∅	9,5	10	10,5	11				
Pcs	10	10	5	5				
∅	11,5	12	12,5	13				
Pcs	5	5	5	5				

Nº Art. 55440: **696,08 €**

Ref. **1001**

BROCA MANGO CILÍNDRICO HSS

HSS Straight Shank Drill Bit
Foret queue cylindrique HSS



CLASSIQUE



HSS + TIN

DIN 338 N



Usos General
General Purpose
Utilisation générale

Aceros
<850 N/mm²
Steel / Aciers

Fundición
Cast Iron
Fonte

Aluminio
Aluminium

D mm	L mm	I mm		Nº Art. HSS	€	Nº Art. TIN	€
1,00	34	12	2	18781	2,40	16527	4,92 *
1,50	40	18	2	18783	1,80	16528	4,23 *
2,00	49	24	2	18792	1,73	16529	4,23 *
2,50	57	30	2	18793	1,73	16530	4,07 *
3,00	61	33	2	18687	1,56	16531	3,85 *
3,25	65	36	2	30156	1,78	16532	4,75 *
3,30	65	36	2	34039	1,78		* *
3,50	70	39	2	18688	1,74	16533	4,67 *
4,00	75	43	2	18589	1,97	16534	4,88 *
4,20	75	43	1	34040	1,11		
4,25	75	43	1	30157	1,11	16535	2,52
4,50	80	47	1	18591	1,12	16536	2,55
5,00	86	52	1	18592	1,20	16537	2,63
5,50	93	57	1	18594	1,61	16538	3,01
6,00	93	57	1	18595	1,66	16539	3,06
6,50	101	63	1	18597	1,88	16540	5,60
6,80	109	69	1	34041	2,29		
7,00	109	69	1	18645	2,29	16541	5,98
7,50	109	69	1	18646	2,37	16542	6,10
8,00	117	75	1	18655	2,73	16543	6,42
8,50	117	75	1	18657	2,95	16544	7,27
9,00	125	81	1	18666	3,59	16545	7,87
9,50	125	81	1	66989	3,81		
10,00	133	87	1	18667	4,07	16546	8,24
10,20	133	87	1	34042	5,11		
10,50	133	87	1	66991	5,11		
11,00	142	94	1	30158	5,94	16547	14,44
11,50	142	94	1	66993	6,37		
12,00	151	101	1	18676	7,07	16549	15,54
12,50	151	101	1	66995	7,78		
13,00	151	101	1	30159	8,03	16550	18,68

* € = 2 uds.

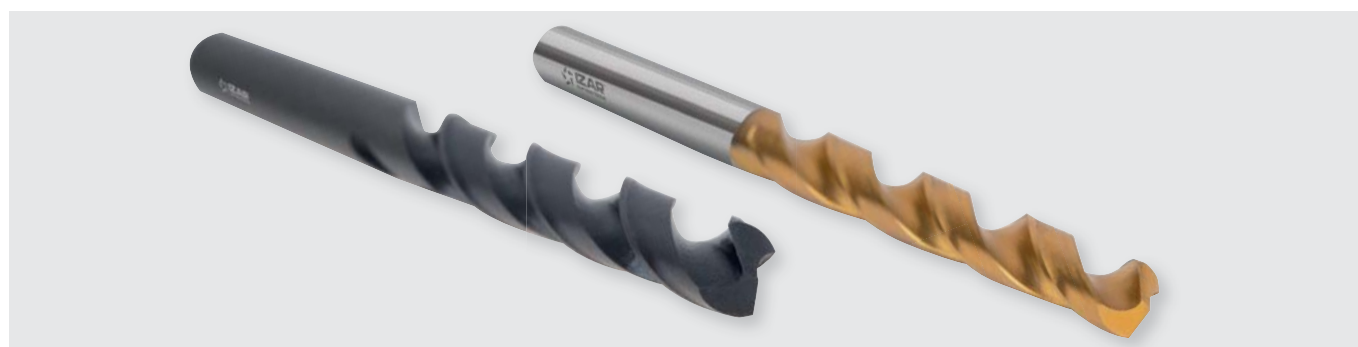

Línea 1m
1001

BROCA MANGO CILÍNDRICO HSS

HSS Straight Shank Drill Bit
Foret queue cylindrique HSS



∅	1	1,5	2	2,5	3	3,25	3,5	4	4,25	4,5	5	5,5	6	6,5	7	7,5	8	9	10	
Packs	10	10	10	10	10	10	10	10	10	10	10	10	10	10	10	10	10	10	10	10

Ref. 4995 - Nº Art. 70942: 383,57 €

Display
14

BROCA MANGO CILÍNDRICO HSS

HSS Straight Shank Drill Bit
Foret queue cylindrique HSS



∅	7,5	8	8,5	9	10	11	12	13		
Packs	5	5	5	5	3	3	3	3		
∅	4	4,25	4,5	5	5	5,5	6	6	6,5	7
Packs	10	10	10	10	10	5	5	5	5	5
∅	1	1,5	2	2,5	3	3	3,25	3,5	3,5	4
Packs	10	10	10	10	10	10	10	10	10	10

Ref. 4995 - Nº Art. 22162: 425,18 €

Display
46

BROCA MANGO CILÍNDRICO HSS + PREVIOS ROSCADO

HSS Straight Shank Drill Bit + Before Threading
Foret queue cylindrique HSS + Pré-Taraudage



∅	8	8,5	9	10	10,2	11	12	13		
Packs	5	5	5	3	3	3	3	3		
∅	4,25	4,5	5	5	5,5	6	6,5	6,8	7	7,5
Packs	15	8	8	7	5	10	5	5	5	5
∅	1	1,5	2	2,5	3	3,25	3,3	3,5	4	4,2
Packs	10	10	10	10	10	10	8	10	10	8

Ref. 4995 - Nº Art. 55618: 419,68 €

Display 51



BROCAS METAL + PARED + MADERA

Metal + Masonry + Wood Drill Bits
Forets Métal + Maçonnerie + Bois

Ref. 1880	∅	3	4	5	6	7	8	9	10	12	14
	Pcs	10	10	10	10	10	10	5	5	5	5
Ref. 1640	∅	3	4	5	6	8	9	10	12	14	16
	Pcs	10	10	10	10	10	5	5	5	5	5
Ref. 1001	∅	1	2	3	3,5	4	4,5	5	6	8	10
	Pcs	10	10	10	10	10	10	10	5	5	3

Ref. 4995 - N° Art. 68572: 352,99 €

Sets 1010

BROCA MANGO CILÍNDRICO HSS

HSS Straight Shank Drill Bit
Foret queue cylindrique HSS



Set **1462**

6 Pcs

Cont. ∅	N° Art.	€
2 - 3 - 4 - 5 - 6 - 8 mm	30230	8,06



New!

Set **1459**

29 Pcs

Cont. ∅	N° Art.	€
1 - 13 x 0,5 mm *	15070	80,58

* + Previos Roscado / Before Threading
Pré-Taraudage (3,3 - 4,2 - 6,8 - 10,2 mm)



Set **1466**

19 Pcs

Cont. ∅	N° Art.	€
1 - 10 x 0,5 mm	25271	34,27



Set **1456**

25 Pcs

Cont. ∅	N° Art.	€
1 - 13 x 0,5 mm	25235	72,39



**Box-Pallet
1010**
5 Sets 1466

Cont. Set	Nº Art.	€
1 - 10 x 0,5 mm	79644	162,76



**Box-Pallet
1010**
5 Sets 1456

Cont. Set	Nº Art.	€
1 - 13 x 0,5 mm	80671	343,82

**Línea 33 cm
14S1**

SETS BROCAS METAL, PARED PRO, PARED, MADERA

Metal, Concrete, Masonry, Wood Sets
Jeux Métal, Béton, Maçonnerie, Bois



23 cm

	Metal Metal Métal	Pared Pro Concrete Béton	Pared Masonry Maçonnerie	Madera Wood Bois
Ref.	1462-1010	1486	1485	1435
Diam.	2-3-4-5-6-8 mm	4-5-6-8-10 mm	4-5-6-8-10 mm	4-5-6-8-10 mm
Pcs.	5	5	5	5

Ref. 4995 - Nº Art. 72193: 181,05 €

**Display
24**

SETS BROCAS MANGO CILINDRICO HSS + HSSE

HSS + HSSE Straight Shank Drill Bit Sets
Jeux forets queue cylindrique HSS + HSSE



HSSE	Pcs	Ref. 1462 - 1016 Metal Pro 5 Pcs. 5	Ref. 1466 - 1016 Metal Pro 19 Pcs. 1	Ref. 1456 - 1016 Metal Pro 25 Pcs. 1
	HSS	Pcs	Ref. 1462 - 1010 Metal 5 Pcs. 5	Ref. 1466 - 1010 Metal 19 Pcs. 2

Ref. 4995 - Nº Art. 22320: 516,71 €

Sets 1010

BROCA MANGO CILÍNDRICO HSS

HSS Straight Shank Drill Bit
Foret queue cylindrique HSS

Set 1407



37 Pcs

Cont. Ø	Nº Art.	€
1 - 10 x 0,25 mm	26768	94,91

Set 1409



49 Pcs

Cont. Ø	Nº Art.	€
1 - 13 x 0,25 mm	26802	174,41

Set 1405



50 Pcs

Cont. Ø	Nº Art.	€
1 - 5,9 x 0,1 mm	26765	64,87

Set 1408



41 Pcs

Cont. Ø	Nº Art.	€
6 - 10 x 0,1 mm	26771	167,27

Set 1406

91 Pcs

Cont. Ø	Nº Art.	€
1-10 x 0,10 mm	56685	230,98



* Base roja / Red base / Base rouge

Set 1410

NOVABOX

New!



55 Pcs

Cont. Ø	Nº Art.	€
1 - 13 x 0,5 mm Ø1,0 - 4,0 mm: 3 pcs Ø4,2 - 8,0 mm: 2 pcs Ø8,50 - 13,0 mm: 1 pcs	19535	136,45

Sets 1470

170 Pcs

Cont. Ø	Nº Art.	€
1-10 x 0,5 mm Ø 1-8: 10 pcs/Ø Ø 8,5-10: 5 pcs/Ø	19590	264,67



220 Pcs

Cont. Ø	Nº Art.	€
1-13 x 0,5 + 3,3 + 4,2 mm Ø 1-8: 10 pcs/Ø Ø 8,5-13: 5 pcs/Ø	56676	503,89



Sets 1010

BROCA MANGO CILÍNDRICO HSS+TIN

HSS+TIN Straight Shank Drill Bit
Foret queue cylindrique HSS+TIN

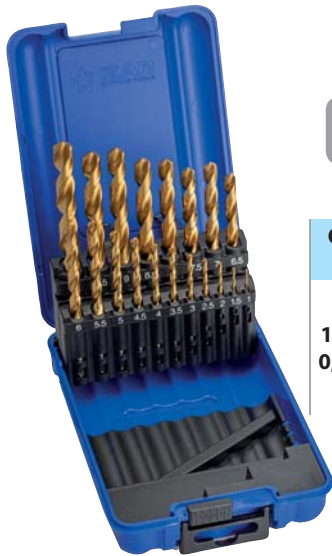

Set **1466**

19 Pcs

Cont. Ø	Nº Art. TIN	€
1 - 10 x 0,5 mm	27132	75,43



Set **1456**

25 Pcs

Cont. Ø	Nº Art. TIN	€
1 - 13 x 0,5 mm	27133	164,55

Set **1407**



37 Pcs

Cont. Ø	Nº Art. TIN	€
1 - 10 x 0,25 mm	27134	176,60

Set **1409**



49 Pcs

Cont. Ø	Nº Art. TIN	€
1 - 13 x 0,25 mm	27135	358,31

Set **1405**



50 Pcs

Cont. Ø	Nº Art. TIN	€
1 - 5,9 x 0,1 mm	13154	120,41

Set **1408**



41 Pcs

Cont. Ø	Nº Art. TIN	€
6 - 10 x 0,1 mm	13152	307,37

Ref. **1013**

BROCA MANGO CILÍNDRICO HSS SPEED POINT

Speed Point HSS Straight Shank Drill Bit
Foret queue cylindrique HSS Speed Point



x3,5

TIALSIN

Resistencia al desgaste
Wear Resistance
Haute résistance à l'usure

Aceros
<850 N/mm²
Steel / Aciers

Fundición
Cast Iron
Fonte

Aluminio
Aluminium

D mm	L mm	I mm		Nº Art. HSS	€	Nº Art. TIALSIN	€
1,00	34	12	10	17673	1,14	37620	2,70
1,10	36	14	10	10650	1,26		
1,20	38	16	10	10656	1,26		
1,30	38	16	10	10662	1,11		
1,40	40	18	10	10663	1,11		
1,50	40	18	10	10666	0,85	37621	2,43
1,60	43	20	10	10669	1,05		
1,70	43	20	10	10670	1,05		
1,75	46	22	10	10671	0,95		
1,80	46	22	10	10672	0,94		
1,90	46	22	10	10674	0,94		
2,00	49	24	10	10675	0,80	37497	2,35
2,10	49	24	10	10677	0,85		
2,20	53	27	10	13596	0,85		
2,25	53	27	10	10679	0,77		
2,30	53	27	10	13608	1,00		
2,40	57	30	10	10683	1,00		
2,50	57	30	10	10684	0,82	37622	2,25
2,60	57	30	10	10685	1,01		
2,70	61	33	10	10686	1,01		
2,75	61	33	10	10687	0,86		
2,80	61	33	10	10690	1,01		
2,90	61	33	10	10692	1,01		
3,00	61	33	10	10693	0,73	37623	2,14
3,10	65	36	10	10695	0,86		
3,20	65	36	10	10696	0,86	32571	2,75
3,25	65	36	10	10698	0,86		
3,30	65	36	10	10699	0,86	37624	2,75
3,40	70	39	10	10701	1,10		
3,50	70	39	10	10702	0,85	37625	2,73
3,60	70	39	10	10704	1,14		
3,70	70	39	10	10705	1,14		
3,75	70	39	10	10708	1,00		
3,80	75	43	10	10710	1,21	39236	3,10
3,90	75	43	10	10719	1,21		
4,00	75	43	10	10770	0,95	32572	2,85
4,10	75	43	10	10774	1,06		
4,20	75	43	10	10776	1,06	36557	2,94

(New!)

D mm	L mm	I mm		Nº Art. HSS	€	Nº Art. TIALSIN	€
4,25	75	43	10	10777	1,06		
4,30	80	47	10	10779	1,42		
4,40	80	47	10	10780	1,42		
4,50	80	47	10	10782	1,09	37627	2,99
4,60	80	47	10	10783	1,45		
4,70	80	47	10	10786	1,45	69082	3,34
4,75	80	47	10	10787	1,28		
4,80	86	52	10	10789	1,58	39240	3,47
4,90	86	52	10	10792	1,55		
5,00	86	52	10	10793	1,19	17442	3,07
5,10	86	52	10	10795	1,59		
5,20	86	52	10	10797	1,59	39242	3,50
5,25	86	52	10	10798	1,53		
5,30	86	52	10	10799	1,99	45421	3,90
5,40	93	57	10	10800	1,99		
5,50	93	57	10	10801	1,57	37628	3,46
5,60	93	57	10	10802	2,09		
5,70	93	57	10	10804	2,09	39244	4,00
5,75	93	57	10	10807	2,05		
5,80	93	57	10	10808	1,99		
5,90	93	57	10	10810	1,99		
6,00	93	57	10	10811	1,60	32677	3,52
6,10	101	63	10	10813	2,30		
6,20	101	63	10	10814	2,30		
6,25	101	63	10	10815	2,15		
6,30	101	63	10	10816	2,43		
6,40	101	63	10	10819	2,46		
6,50	101	63	10	10822	1,89	36558	7,14
6,60	101	63	10	11145	3,03		
6,70	101	63	10	11154	3,03	45424	8,28
6,75	109	69	10	11157	2,29	66924	7,54
6,80	109	69	10	11163	2,29	37629	7,54
6,90	109	69	10	11166	3,32	45725	8,56
7,00	109	69	10	11172	2,29	36559	7,54
7,10	109	69	10	11175	3,53		
7,20	109	69	10	13066	3,53		
7,25	109	69	10	11184	2,89		
7,30	109	69	10	11190	3,53		

Ref. **1013**

BROCA MANGO CILÍNDRICO HSS SPEED POINT

Speed Point HSS Straight Shank Drill Bit
Foret queue cylindrique HSS Speed Point



D mm	L mm	I mm		Nº Art. HSS	€	Nº Art. TIALSIN	€		D mm	L mm	I mm		Nº Art. HSS	€	Nº Art. TIALSIN	€	
7,40	109	69	10	11202	3,53				New! 10,75	142	94	5	53633	6,72			
7,50	109	69	10	11217	2,40	37630	7,65		10,80	142	94	5	17972	8,09			
7,60	117	75	10	14362	4,18				10,90	142	94	5	17975	8,09			
7,70	117	75	10	11226	4,18				11,00	142	94	5	13783	6,18	37635	17,99	
7,75	117	75	10	11229	3,22				11,10	142	94	5	17978	8,25			
7,80	117	75	10	11230	4,21				11,20	142	94	5	66583	8,25			
7,90	117	75	10	11251	4,21				New! 11,25	142	94	5	53636	6,87			
8,00	117	75	10	11268	2,75	36560	8,00		11,30	142	94	5	17980	8,25			
8,10	117	75	5	11269	4,29				11,40	142	94	5	17981	8,25			
8,20	117	75	5	11287	4,29	64063	10,38		11,50	142	94	5	17609	6,60	37636	18,43	
8,25	117	75	5	11290	3,22				11,60	142	94	5	17982	8,10			
8,30	117	75	5	11297	4,49				11,70	142	94	5	19657	8,10			
8,40	117	75	5	11302	4,49				11,80	142	94	5	17984	8,85			
8,50	117	75	5	11303	2,97	37498	9,04		11,90	151	101	5	17987	8,85			
8,60	125	81	5	11304	5,64				12,00	151	101	5	17611	7,35	37637	19,20	
8,70	125	81	5	11305	5,64				12,10	151	101	5	63357	10,34			
8,75	125	81	5	11306	4,32				12,20	151	101	5	63358	10,34			
8,80	125	81	5	11307	5,66				New! 12,25	151	101	5	53639	8,94			
8,90	125	81	5	11308	5,66				12,30	151	101	5	22343	9,72			
9,00	125	81	5	11310	3,63	37631	9,70		12,40	151	101	5	63360	9,72			
9,10	125	81	5	14378	5,69	39252	11,79		12,50	151	101	5	17615	8,06	37638	22,97	
9,20	125	81	5	14304	5,69	64064	11,78		12,60	151	101	5	63361	10,12			
9,25	125	81	5	11313	4,38				12,70	151	101	5	17081	10,12			
9,30	125	81	5	14305	5,29				New! 12,75	151	101	5	53645	8,81			
9,40	125	81	5	13007	5,29				12,80	151	101	5	63363	11,25			
9,50	125	81	5	11317	3,93	37632	10,02		12,90	151	101	5	63364	11,25			
9,60	133	87	5	11318	6,79				13,00	151	101	5	16556	8,35	36556	23,28	
9,70	133	87	5	13440	6,79				13,50	160	108	1	22833	11,84	83459	26,70	
9,75	133	87	5	11321	4,95				14,00	160	108	1	19224	12,70	64065	27,56	
9,80	133	87	5	11322	6,69				14,50	169	114	1	24941	13,65			
9,90	133	87	5	11323	6,69				New! 15,00	169	114	1	19227	13,82	12770	28,29	
10,00	133	87	5	11324	4,23	36147	10,32		15,50	178	120	1	51929	15,87			
10,10	133	87	5	22341	5,69				New! 16,00	178	120	1	22306	16,84	12771	28,58	
10,20	133	87	5	17648	5,28	37633	17,12		16,50	184	125	1	51640	18,63			
New! 10,25	133	87	5	53630	5,81				New! 17,00	184	125	1	48580	18,63	12784	32,01	
10,30	133	87	5	17506	6,64	37634	18,49		17,50	191	130	1	48582	21,42			
10,40	133	87	5	17966	6,64				New! 18,00	191	130	1	48583	22,67	12792	36,06	
10,50	133	87	5	17613	5,28	38088	17,12		18,50	198	135	1	48585	25,18			
10,60	133	87	5	17969	7,28				New! 19,00	198	135	1	48586	25,18	12793	38,56	
10,70	142	94	5	22342	7,28				19,50	205	140	1	48588	26,98			
									New! 20,00	205	140	1	48589	30,75	12794	44,14	



Expo
1013

BROCA MANGO CILÍNDRICO HSS SPEED POINT

Speed Point HSS Straight Shank Drill Bit
Foret queue cylindrique HSS Speed Point



Cuartos / Quarters / Quarts

∅	1	1,5	2	2,5	3	3,25
Pcs	30	20	40	30	50	30
∅	3,5	4	4,25	4,5	5	
Pcs	30	50	30	30	50	
∅	5,5	6	6,5	7		
Pcs	40	50	20	20		
∅	7,5	8	8,5	9		
Pcs	20	40	20	20		
∅	9,5	10	11	12	13	
Pcs	5	20	5	10	5	

Nº Art. 57524: **1.133,56 €**

Previos Roscado / Before Threading / Pré-Taradage

∅	1	1,5	2	2,5	3	3,3
Pcs	30	20	40	30	50	30
∅	3,5	4	4,2	4,5	5	
Pcs	30	50	30	30	50	
∅	5,5	6	6,5	6,8		
Pcs	40	50	20	10		
∅	7	7,5	8	8,5		
Pcs	20	20	40	20		
∅	9	9,5	10	10,2	11	12
Pcs	20	5	20	5	5	10
						13
						5

Nº Art. 57976: **1.182,79 €**

Línea 1m
1013

BROCA MANGO CILÍNDRICO HSS SPEED POINT

Speed Point HSS Straight Shank Drill Bit
Foret queue cylindrique HSS Speed Point

Cuartos / Quarters / Quarts

1,5 20	3	4	5	6 50	7 20	8 40	9 20	10 20	12 10	mm pcs
	2,5	3,5	4,5							
1 30	2	3,25	4,25	5,5 40	6,5 20	7,5 20	8,5 20	9,5 5	11 5	13 5

Nº Art. 71057: **1.133,56 €**

Previos Roscado / Before Threading / Pré-Taradage

1,5 30	3	4	5	6 50	7 20	8 40	9,5 5	10,2 5	12 10	mm pcs
	2,5	3,5	4,5							
1 20	2	3,3	4,2	5,5 40	6,8 10	7,5 20	9 20	10 20	11 5	13 5

Nº Art. 71390: **1.182,79 €**



Cabinet 1013

BROCA MANGO CILÍNDRICO HSS SPEED POINT

Speed Point HSS Straight Shank Drill Bit
Foret queue cylindrique HSS Speed Point



350 Pcs

∅	1	1,5	2	2,5	3	3,5	4	4,5		
Pcs	10	10	20	20	40	20	40	20		
∅	5		5,5		6		6,5		7	
Pcs	30		10		30		10		10	
∅	7,5			8		8,5		9		
Pcs	10			20		5		5		
∅	9,5			10		10,5		11		
Pcs	5			5		5		5		
∅	11,5			12		12,5		13		
Pcs	5			5		5		5		

Nº Art. 55443: **661,34 €**

Ref. **1002**

BROCA MANGO CILÍNDRICO HSS SPEED POINT

Speed Point HSS Straight Shank Drill Bit
Foret queue cylindrique HSS Speed Point



SPEED POINT



Aceros
<850 N/mm²
Steel / Aciers

Fundición
Cast Iron
Fonte

Aluminio
Aluminium



D mm	L mm	I mm		Nº Art.	€
1,00	34	12	2	24778	2,64 *
1,50	40	18	2	16516	1,97 *
2,00	49	24	2	24779	1,88 *
2,50	57	30	2	24780	1,92 *
3,00	61	33	2	24781	1,71 *
3,25	65	36	2	24782	1,95 *
3,30	65	36	2	39913	1,95 *
3,50	70	39	2	24783	1,92 *
3,80	75	43	2	79610	2,73 *
4,00	75	43	2	24784	2,16 *
4,20	75	43	1	39914	1,20
4,25	75	43	1	24785	1,20
4,50	80	47	1	24786	1,24
4,80	86	52	1	79611	1,79
5,00	86	52	1	24787	1,34
5,20	86	52	1	73529	1,81
5,50	93	57	1	24788	1,78
5,80	93	57	1	79612	2,26
6,00	93	57	1	24789	1,83
6,50	101	63	1	24790	2,06
6,80	109	69	1	39915	2,50
7,00	109	69	1	24791	2,50
7,50	109	69	1	24792	2,63
8,00	117	75	1	24793	3,00
8,50	117	75	1	24794	3,24
9,00	125	81	1	24795	3,96
9,50	125	81	1	74946	4,30
10,00	133	87	1	24796	4,49
10,20	133	87	1	39916	5,61
10,50	133	87	1	74949	5,61
11,00	142	94	1	24797	6,53
11,50	142	94	1	74950	7,01
12,00	151	101	1	24798	7,78
12,50	151	101	1	79613	8,54
13,00	151	101	1	24799	8,87
14,00	160	108	1	79614	13,47



* € = 2 uds.



Línea 1m
1002

BROCA MANGO CILÍNDRICO HSS SPEED POINT

Speed Point HSS Straight Shank Drill Bit
Foret queue cylindrique HSS Speed Point



∅	1	1,5	2	2,5	3	3,25	3,5	4	4,25	4,5	5	5,5	6	6,5	7	7,5	8	9	10	
Packs	10	10	10	10	10	10	10	10	10	10	10	10	10	10	10	10	10	10	10	10

Ref. 4995 - N° Art. 70947: 421,84 €

Display
17

BROCA MANGO CILÍNDRICO HSS SPEED POINT

Speed Point HSS Straight Shank Drill Bit
Foret queue cylindrique HSS Speed Point



∅	7,5	8	8,5	9	10	11	12	13		
Packs	8	8	5	5	3	3	3	3		
∅	4	4,25	4,5	5	5	5,5	6	6	6,5	7
Packs	5	10	10	5	5	10	5	5	10	8
∅	1	1,5	2	2,5	3	3	3,25	3,5	3,5	4
Packs	10	10	10	10	5	5	10	5	5	5

Ref. 4995 - N° Art. 22492: 440,05 €

Display 47



BROCA M. CILÍNDRICO HSS SPEED POINT + PREVIOS ROSCADO

Speed Point HSS Straight Shank Drill Bit + Before Threading

Foret queue cylindrique HSS Speed Point + Pré-Taroudage

∅	8	8,5	9	10	10,2	11	12	13		
Pcs	5	5	5	3	3	3	3	3	3	
∅	4,25	4,5	5	5	5,5	6	6,5	6,8	7	7,5
Pcs	10	5	5	5	5	10	5	5	5	5
∅	1	1,5	2	2,5	3	3,25	3,3	3,5	4	4,2
Pcs	10	10	10	5	10	10	5	10	10	5

Ref. 4995 - N° Art. 55620: 425,73 €

Display 59



BROCAS SPEED POINT + PARED + MADERA

Speed Point + Masonry + Wood Drill Bits

Forets Speed Point + Maçonnerie + Bois

Ref. 1880	∅	3	4	5	6	7	8	9	10	12	14
	Pcs	10	10	10	10	10	10	5	5	5	5
Ref. 1640	∅	3	4	5	6	8	9	10	12	14	16
	Pcs	10	10	10	10	10	5	5	5	5	5
Ref. 1002	∅	2	3	3,5	4	4,5	5	6	7	8	10
	Pcs	10	10	10	10	10	10	5	5	5	3

Ref. 4995 - N° Art. 70099: 354,32 €

Sets 1013

BROCA MANGO CILÍNDRICO HSS SPEED POINT

Speed Point HSS Straight Shank Drill Bit
Foret queue cylindrique HSS Speed Point



Set **1462**

6 Pcs

Cont. Ø	Nº Art.	€
2 - 3 - 4 - 5 - 6 - 8 mm	25365	8,88



New!

Set **1459**

29 Pcs

Cont. Ø	Nº Art.	€
1 - 13 x 0,5 mm *	15088	89,84

* + Previos Roscado / Before Threading
Pré-Taraudage (3,3 - 4,2 - 6,8 - 10,2 mm)



Set **1466**

19 Pcs

Cont. Ø	Nº Art.	€
1 - 10 x 0,5 mm	18808	38,05



Set **1456**

25 Pcs

Cont. Ø	Nº Art.	€
1 - 13 x 0,5 mm	18807	80,64



Box-Pallet
1013

5 Sets 1466

Cont. Set	Nº Art.	€
1 - 10 x 0,5 mm	80659	180,76



Box-Pallet
1013

5 Sets 1456

Cont. Set	Nº Art.	€
1 - 13 x 0,5 mm	80675	383,05

Sets 1013

BROCA MANGO CILÍNDRICO HSS SPEED POINT

Speed Point HSS Straight Shank Drill Bit
Foret queue cylindrique HSS Speed Point



TIALSIN Set **1466**
19 Pcs

Cont. Ø	Nº Art. TIALSIN	€
1 - 10 x 0,5 mm	38833	102,29

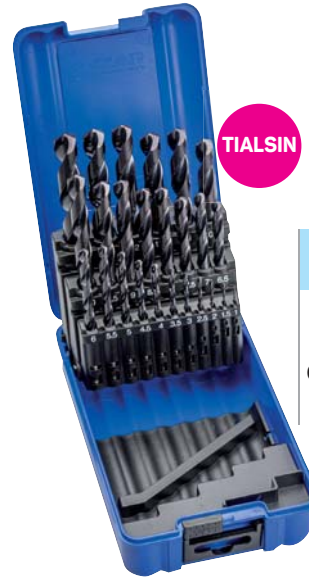

TIALSIN Set **1456**
25 Pcs

Cont. Ø	Nº Art. TIALSIN	€
1 - 13 x 0,5 mm	38832	222,05

Set **1406**

91 Pcs

Cont. Ø	Nº Art.	€
1-10 x 0,10 mm	60624	255,64

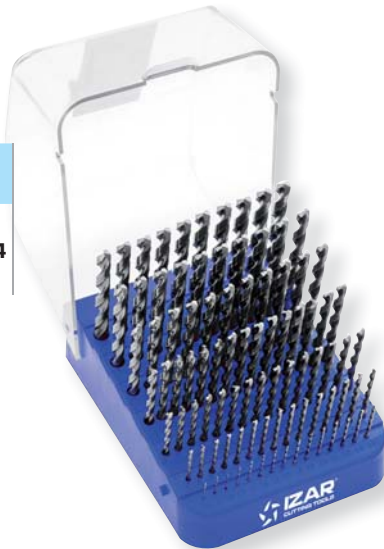

* Base roja / Red base / Base rouge

Set **1410** **NOVABOX**

New!



55 Pcs

Cont. Ø	Nº Art.	€
1 - 13 x 0,5 mm Ø1,0 - 4,0 mm: 3 pcs Ø4,2 - 8,0 mm: 2 pcs Ø8,50 - 13,0 mm: 1 pcs	19536	148,37

Sets **1470**

170 Pcs

Cont. Ø	Nº Art.	€
1-10 x 0,5 mm Ø 1-8: 10 pcs/Ø Ø 8,5-10: 5 pcs/Ø	56677	294,68



220 Pcs

Cont. Ø	Nº Art.	€
1-13 x 0,5 + 3,3 + 4,2 mm Ø 1-8: 10 pcs/Ø Ø 8,5-13: 5 pcs/Ø	56679	558,17



Ref. **1007**

BROCA MANGO REBAJADO HSS

HSS Reduced Shank Drill Bit
Foret queue reduite HSS



Aceros
<850 N/mm²
Steel / Aciers

Fundición
Cast Iron
Fonte

Aluminio
Aluminium

D	d	L	l	∅	Nº	€	D	d	L	l	∅	Nº	€	D	d	L	l	∅	Nº	€
mm	mm	mm	mm		Art.		mm	mm	mm	mm		Art.		mm	mm	mm	mm		Art.	
10,50	10,00	133	87	1	15976	7,02	15,50	12,70	178	120	1	15988	18,24	20,50	12,70	205	145	1	66932	37,24
11,00	10,00	142	94	1	15977	7,94	16,00	12,70	178	120	1	15989	18,91	21,00	12,70	205	145	1	17071	37,24
11,50	10,00	142	94	1	15978	8,40	16,50	12,70	184	125	1	15990	21,21	21,50	12,70	210	150	1	66933	41,06
12,00	10,00	151	101	1	15979	9,17	17,00	12,70	184	125	1	15991	21,21	22,00	12,70	210	150	1	17072	41,06
12,50	10,00	151	101	1	15980	9,94	17,50	12,70	191	130	1	15992	24,14	22,50	12,70	210	150	1	66934	44,92
13,00	10,00	151	101	1	15981	10,22	18,00	12,70	191	130	1	15993	25,42	23,00	12,70	210	150	1	36364	44,92
13,50	12,70	160	108	1	15982	13,81	18,50	12,70	198	135	1	15994	28,05	23,50	12,70	220	160	1	66935	49,58
14,00	12,70	160	108	1	15984	14,66	19,00	12,70	198	135	1	15995	28,05	24,00	12,70	220	160	1	36365	49,58
14,50	12,70	169	114	1	15985	15,66	19,50	12,70	205	140	1	15996	30,56	24,50	12,70	220	160	1	66936	54,04
15,00	12,70	169	114	1	15987	15,82	20,00	12,70	205	140	1	15997	35,20	25,00	12,70	220	160	1	36366	54,04

Línea 1m
1007

BROCA MANGO REBAJADO HSS

HSS Reduced Shank Drill Bit
Foret queue reduite HSS



∅	12	12,5	13	13,5	14	15	15,5	16	16,5	17	17,5	18	18,5	19	19,5	20
Pcs	2	2	2	2	2	2	2	2	2	2	2	2	2	2	2	2

Ref. 4995 - Nº Art. 70951: **649,18 €**

Display
18

BROCA MANGO REBAJADO HSS

HSS Reduced Shank Drill Bit
Foret queue reduite HSS



∅	17	17,5	18	18	18,5	19	19,5	20
Pcs	2	2	1	1	1	1	1	1
∅	14	14	14,5	15	15,5	16	16	16,5
Pcs	2	1	2	2	2	1	1	2
∅	10,5	11	11,5	12	12	12,5	13	13,5
Pcs	2	2	2	2	1	2	2	2

Ref. 4995 - Nº Art. 22352: **629,17 €**

Ref. **1012**

BROCA MANGO CILÍNDRICO HSS

HSS Straight Shank Drill Bit
Foret queue cylindrique HSS



HSS

DIN
338 H



Cobre
Copper
Cuivre

Bronce
Bronze

Latón
Brass
Laiton



D mm	L mm	I mm		Nº Art.	€	D mm	L mm	I mm		Nº Art.	€
1,00	34	12	10	10586	2,64	7,50	109	69	10	10625	6,74
1,25	38	16	10	27590	2,97	7,75	117	75	10	19022	14,44
1,50	40	18	10	10589	2,63	8,00	117	75	10	10628	7,18
2,00	49	24	10	10592	2,35	8,25	117	75	10	19031	13,47
2,25	53	27	10	18908	2,50	8,50	117	75	10	10631	8,32
2,50	57	30	10	10595	2,16	9,00	125	81	10	10634	8,76
2,75	61	33	10	18917	2,94	9,50	125	81	10	10637	10,26
3,00	61	33	10	10598	2,40	9,75	133	87	10	19040	22,98
3,25	65	36	10	18932	2,94	10,00	133	87	10	10640	10,70
3,50	70	39	10	10601	2,57	10,50	133	87	5	10643	12,84
*3,75	70	39	10	18941	3,82	11,00	142	94	5	10646	14,31
4,00	75	43	10	10604	2,80	11,50	142	94	5	10649	17,31
4,25	75	43	10	18953	4,17	12,00	151	101	5	10652	18,66
4,50	80	47	10	10607	3,42	12,50	151	101	5	10655	21,16
4,75	80	47	10	18968	5,43	13,00	151	101	5	10658	22,68
5,00	86	52	10	10610	3,71	14,00	160	108	1	18863	34,61
5,20	86	52	10	18974	5,69	14,50	169	114	1	46846	49,69
5,25	86	52	10	18977	5,60	15,00	169	114	1	54158	51,18
5,50	93	57	10	10613	4,52	16,00	178	120	1	46847	54,39
*5,75	93	57	10	18980	6,86	16,50	184	125	1	46848	55,93
6,00	93	57	10	10616	4,88	17,00	184	125	1	46849	57,64
6,25	101	63	10	18986	6,86	18,00	191	130	1	54159	61,20
6,50	101	63	10	10619	5,43	18,50	198	135	1	46851	62,81
6,75	109	69	10	18998	8,26	19,00	198	135	1	46852	64,78
7,00	109	69	10	10622	5,73	20,00	205	140	1	46850	68,39
7,25	109	69	10	19013	10,92						

* Diam. hasta fin de existencias / while stock lasts / jusqu'à la fin de stock

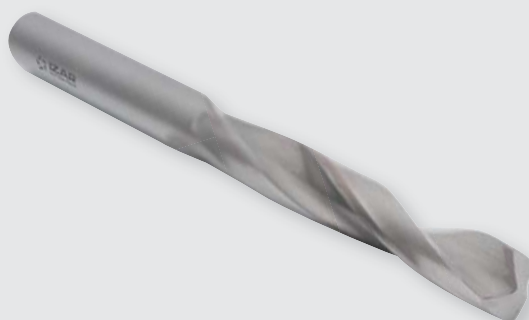

Ref. **1025**

BROCA MANGO CILÍNDRICO CORTE IZQUIERDA

Left Hand Straight Shank Drill Bit

Foret queue cylindrique coupe à gauche



HSS
Aceros
<850 N/mm²
Steel / Aciers

Fundición
Cast Iron
Fonte

Aluminio
Aluminium

D mm	L mm	I mm		Nº Art.	€
1,00	34	12	10	10554	3,52
1,50	40	18	10	10560	3,52
2,00	49	24	10	10562	3,20
2,50	57	30	10	10564	3,20
3,00	61	33	10	10569	2,43
3,50	70	39	10	11121	2,84
4,00	75	43	10	11566	3,20
4,50	80	47	10	11811	3,64
5,00	86	52	10	11817	3,93
5,50	93	57	10	11820	5,23
6,00	93	57	10	12001	5,38
6,50	101	63	10	12330	6,28

D mm	L mm	I mm		Nº Art.	€
7,00	109	69	10	12336	7,62
7,50	109	69	10	12339	8,01
8,00	117	75	10	12345	9,17
8,50	117	75	10	12348	9,88
9,00	125	81	10	12399	12,03
9,50	125	81	10	12408	13,13
10,00	133	87	10	12417	14,13
11,00	142	94	5	70015	22,76
12,00	151	101	5	70016	27,05
13,00	151	101	5	70017	34,12

Sets
1025

BROCA MANGO CILÍNDRICO CORTE IZQUIERDA

Left Hand Straight Shank Drill Bit

Foret queue cylindrique coupe à gauche



Set **1462**

6 Pcs

Cont. Ø	Nº Art.	€
2 - 3 - 4 - 5 - 6 - 8 mm	67380	28,19



Set **1466**

19 Pcs

Cont. Ø	Nº Art.	€
1 - 10 x 0,5 mm	66659	122,74

Ref. **1660**

BROCA MANGO CILÍNDRICO HSS DOBLE

Double HSS Straight Shank Drill Bit
Foret queue cylindrique HSS double



HSS
IZAR Std.
135°
< 3 mm
Chapa Sheets Tôle

Aceros
<850 N/mm²
Steel / Aciers



D	L	I		N°	€	D	L	I		N°	€
mm	mm	mm		Art.		mm	mm	mm		Art.	
2,00	38	9	10	16028	1,86	4,25	58	16	10	16085	1,99
2,20	40	9	10	27607	1,71	4,50	58	16	10	16088	2,05
New! 2,25	43	10	10	16031	1,95	4,75	62	18	10	16094	3,32
2,30	43	10	10	25604	2,20	4,80	62	18	10	16097	2,27
New! 2,40	43	10	10	25607	2,20	4,90	62	18	10	16100	2,27
2,50	43	10	10	16034	1,84	5,00	62	18	10	16103	2,34
New! 2,75	46	13	10	16037	1,73	5,10	66	19	10	16106	3,20
2,80	46	13	10	16040	1,73	5,20	66	19	10	16109	3,20
2,90	46	13	10	16043	1,73	5,25	66	19	10	16112	3,32
3,00	46	13	10	16046	1,60	5,50	66	19	10	16115	2,84
3,10	52	14	10	16049	1,60	5,70	66	19	10	25634	3,76
3,20	52	14	10	16052	1,60	5,75	66	19	10	16121	3,92
3,25	52	14	10	16055	1,60	6,00	66	19	10	16127	3,18
3,30	52	14	10	16058	1,60	New! 6,10	70	21	10	25640	4,29
3,40	52	14	10	16061	1,79	New! 6,20	70	21	10	25643	4,29
3,50	52	14	10	16064	1,79	6,50	70	21	10	16133	3,51
3,70	55	15	10	16067	1,99	7,00	74	24	10	16136	4,19
3,75	55	15	10	16070	2,05	7,40	74	24	10	25664	5,76
3,80	55	15	10	16073	1,99	7,50	74	24	10	16139	4,28
4,00	55	15	10	16076	1,84	8,00	79	25	10	16142	5,12
4,10	58	16	10	16079	1,99	9,00	84	25	10	16148	6,85
4,20	58	16	10	16082	1,99	10,00	89	27	10	16154	7,37



Ref. 1050

BROCA MANGO CILÍNDRICO HSS EXTRA CORTA

HSS Straight Shank Stub Drill Bit

Foret queue cylindrique HSS extra-courte



HSS	DIN 1897 N				Serie Extra Corta Stub Series Série extra-courte	Aceros <850 N/mm ² Steel / Aciers	Fundición Cast Iron Fonte	Aluminio Aluminium
-----	------------	--	--	--	---	---	--	------------------------------

	D	L	I		N°	€
	mm	mm	mm		Art.	
	1,00	26	6	10	20606	1,18
New!	1,10	28	7	10	48338	1,38
New!	1,20	30	8	10	48341	1,38
	1,25	30	8	10	20615	1,03
New!	1,30	30	8	10	48344	1,38
New!	1,40	32	9	10	48347	1,38
	1,50	32	9	10	12302	1,03
	1,60	34	10	10	12305	1,19
New!	1,70	34	10	10	48350	1,38
	1,75	36	11	10	12311	1,18
	1,80	36	11	10	12314	1,19
	1,90	36	11	10	12317	1,19
	2,00	38	12	10	12320	1,02
	2,10	40	13	10	12323	1,07
	2,20	40	13	10	12326	1,07
	2,25	40	13	10	12329	0,92
	2,30	40	13	10	12332	1,07
	2,40	43	14	10	12335	1,07
	2,50	43	14	10	12338	0,82
	2,60	43	14	10	12341	1,00
	2,70	46	16	10	12344	1,00
	2,75	46	16	10	12347	0,88
	2,80	46	16	10	12350	1,01
	2,90	46	16	10	12353	1,01
	3,00	46	16	10	12356	0,88
	3,10	49	18	10	12359	0,94
	3,20	49	18	10	12362	0,94
	3,25	49	18	10	12365	0,94
	3,30	49	18	10	12368	0,94
	3,40	52	20	10	12371	1,07
	3,50	52	20	10	12374	0,94
	3,60	52	20	10	12377	1,19
	3,70	52	20	10	12380	1,19
	3,75	52	20	10	12383	1,04
	3,80	55	22	10	12386	1,19
	3,90	55	22	10	12389	1,19
	4,00	55	22	10	12392	1,04
	4,10	55	22	10	12395	1,23
	4,20	55	22	10	12398	1,23
	4,25	55	22	10	12401	1,23
	4,30	58	24	10	12404	1,40
	4,40	58	24	10	12407	1,40
	4,50	58	24	10	12410	1,23
	4,60	58	24	10	20636	1,59
	4,70	58	24	10	20639	1,59
	4,75	58	24	10	12413	1,37
	4,80	62	26	10	12416	1,59
	4,90	62	26	10	12419	1,59
	5,00	62	26	10	12422	1,37
	5,10	62	26	10	12425	1,74
	5,20	62	26	10	12428	1,74
	5,25	62	26	10	12431	1,52
	5,30	62	26	10	12434	1,75
	5,40	66	28	10	12437	1,75
	5,50	66	28	10	12440	1,52
	5,60	66	28	10	12443	2,01
	5,70	66	28	10	12446	2,01
	5,75	66	28	10	12449	1,73

	D	L	I		N°	€
	mm	mm	mm		Art.	
	5,80	66	28	10	12452	2,01
	5,90	66	28	10	12455	2,01
	6,00	66	28	10	12458	1,73
	6,10	70	31	10	20651	2,35
	6,20	70	31	10	20654	2,35
	6,25	70	31	10	12461	2,06
	6,30	70	31	10	20657	2,35
	6,40	70	31	10	20663	2,35
	6,50	70	31	10	12464	2,06
	6,60	70	31	10	20666	2,76
	6,70	70	31	10	20669	2,76
	6,75	74	34	10	12467	2,37
	6,80	74	34	10	20672	2,37
New!	6,90	74	34	10	48353	2,52
	7,00	74	34	10	12470	2,37
New!	7,10	74	34	10	48362	3,07
	7,20	74	34	10	20681	3,07
	7,25	74	34	10	27317	2,70
New!	7,30	74	34	10	48365	2,97
	7,40	74	34	10	30591	2,97
	7,50	74	34	10	12473	2,70
New!	7,60	79	37	10	48368	3,41
New!	7,70	79	37	10	48383	3,41
	7,75	79	37	10	12476	2,97
	7,80	79	37	10	20696	3,41
New!	7,90	79	37	10	48386	3,41
	8,00	79	37	10	12479	2,97
New!	8,10	79	37	10	48389	3,96
New!	8,20	79	37	10	48392	3,96
	8,25	79	37	10	12482	3,53
New!	8,30	79	37	10	48395	3,96
New!	8,40	79	37	10	48398	3,96
	8,50	79	37	10	12485	3,53
New!	8,70	84	40	10	20720	4,10
	8,75	84	40	10	12488	3,87
New!	8,80	84	40	10	48401	4,10
New!	8,90	84	40	10	48404	4,10
	9,00	84	40	10	12491	3,87
New!	9,10	84	40	10	30592	4,82
New!	9,20	84	40	10	48407	4,82
	9,25	84	40	10	12494	4,32
New!	9,30	84	40	10	48410	4,82
New!	9,40	84	40	10	48413	4,82
	9,50	84	40	10	12497	4,32
New!	9,60	89	43	10	48416	6,60
New!	9,70	89	43	10	48419	6,60
	9,75	89	43	10	27334	4,82
New!	9,80	89	43	10	48422	5,10
New!	9,90	89	43	10	48335	5,10
	10,00	89	43	10	12500	4,82
New!	10,10	89	43	1	48428	5,84
New!	10,15	89	43	1	16195	5,84
	10,20	89	43	1	20756	5,46
	10,25	89	43	1	12503	6,05
New!	10,30	89	43	1	48431	6,41
	10,50	89	43	1	12506	5,46
New!	10,80	95	47	1	48434	6,90
	11,00	95	47	1	12512	6,05

	D	L	I		N°	€
	mm	mm	mm		Art.	
	11,10	95	47	1	30593	7,12
New!	11,20	95	47	1	48437	7,12
	11,25	95	47	1	12515	6,73
	11,50	95	47	1	12518	6,73
New!	11,80	95	47	1	48449	8,59
	12,00	102	51	1	12527	7,12
New!	12,10	102	51	1	48452	9,05
New!	12,20	102	51	1	48455	9,05
	12,25	102	51	1	12530	8,01
	12,50	102	51	1	12533	8,01
	12,70	102	51	1	20813	8,43
	13,00	102	51	1	12539	8,75
	13,50	107	54	1	12545	11,12
	14,00	107	54	1	12551	12,01
	14,50	111	56	1	12554	13,72
	15,00	111	56	1	12557	15,68
New!	15,25	115	58	1	48797	23,05
	15,50	115	58	1	12560	18,89
New!	15,75	115	58	1	20834	23,05
	16,00	115	58	1	12563	18,89
	16,50	119	60	1	12566	22,23
	17,00	119	60	1	12569	22,23
	17,50	123	62	1	12572	24,77
	18,00	123	62	1	12575	24,77
	18,50	127	64	1	12578	27,57
	19,00	127	64	1	12581	27,57
	19,50	131	66	1	12584	33,07
	20,00	131	66	1	12587	33,07

Set 1476



19 Pcs

Cont. Ø	N° Art.	€
1 - 10 x 0,5 mm	11935	59,49

Ref. **1030**

BROCA MANGO CILÍNDRICO HSS LARGA



HSS Straight Shank Long Drill Bit

Foret queue cylindrique HSS longue



HSS **DIN 340 N** **118°** **Serie Larga**
Long Series
Série longue

Aceros <850 N/mm²
Steel / Aciers **Fundición**
Cast Iron **Aluminio**
Fonte **Aluminium**



D mm	L mm	I mm		Nº Art.	€	D mm	L mm	I mm		Nº Art.	€
0,50	32	12	10	26656	5,60	4,20	119	78	10	11687	3,26
0,60	35	15	10	26658	4,55	4,25	119	78	10	11690	3,26
0,70	42	21	10	19467	4,55	4,30	126	82	10	11693	4,21
0,80	46	25	10	24592	4,55	4,40	126	82	10	11696	4,21
0,90	51	29	10	26659	4,55	4,50	126	82	10	11699	2,97
1,00	56	33	10	11573	4,60	4,60	126	82	10	11702	4,21
1,10	60	37	10	11576	4,47	4,70	126	82	10	19955	4,21
1,20	65	41	10	11579	4,47	4,75	126	82	10	11705	4,39
1,25	65	41	10	11582	4,61	4,80	132	87	10	11708	4,87
1,30	65	41	10	11585	4,47	4,90	132	87	10	11711	4,87
1,40	70	45	10	11588	4,47	5,00	132	87	10	11714	3,19
New! 1,45	70	45	10	31704	4,47	5,10	132	87	10	11717	4,87
1,50	70	45	10	11591	3,32	5,20	132	87	10	11720	4,87
1,60	76	50	10	11594	4,47	5,25	132	87	10	11723	5,05
1,70	76	50	10	11597	4,47	5,30	132	87	10	11726	5,29
1,75	80	53	10	11600	3,70	5,40	139	91	10	11729	5,29
1,80	80	53	10	11603	3,55	5,50	139	91	10	11732	4,20
1,90	80	53	10	11606	3,55	5,60	139	91	10	11735	5,29
2,00	85	56	10	11609	2,35	5,70	139	91	10	11738	5,29
2,10	85	56	10	11612	3,24	5,75	139	91	10	11741	5,50
2,20	90	59	10	11615	3,24	5,80	139	91	10	11744	5,83
2,25	90	59	10	11618	2,59	5,90	139	91	10	11747	5,83
2,30	90	59	10	11621	3,12	6,00	139	91	10	11750	3,90
2,40	95	62	10	11624	3,12	6,10	148	97	10	11753	5,83
2,50	95	62	10	11627	2,35	6,20	148	97	10	11756	5,83
2,60	95	62	10	11630	3,12	6,25	148	97	10	11759	6,04
2,70	100	66	10	11633	3,12	6,30	148	97	10	11762	5,89
2,75	100	66	10	11636	3,24	6,40	148	97	10	11765	5,89
2,80	100	66	10	11639	3,12	6,50	148	97	10	11768	4,99
2,90	100	66	10	11642	3,12	6,60	148	97	10	11771	5,89
3,00	100	66	10	11645	2,19	6,70	148	97	10	11774	5,89
3,10	106	69	10	11648	2,43	6,75	156	102	10	11777	6,11
3,20	106	69	10	11651	2,43	6,80	156	102	10	11780	6,11
3,25	106	69	10	11654	2,43	6,90	156	102	10	11783	6,25
3,30	106	69	10	11657	2,43	7,00	156	102	10	11786	5,82
3,40	112	73	10	11660	3,12	7,10	156	102	10	11789	6,25
3,50	112	73	10	11663	2,30	7,20	156	102	10	11792	6,25
3,60	112	73	10	11666	3,12	7,25	156	102	10	11795	6,50
3,70	112	73	10	11669	3,12	7,30	156	102	10	11798	6,38
3,75	112	73	10	11672	3,24	7,40	156	102	10	11801	6,38
3,80	119	78	10	11675	3,89	7,50	156	102	10	11804	6,19
3,90	119	78	10	11678	3,89	7,60	165	109	10	11807	6,38
4,00	119	78	10	11681	2,49	7,70	165	109	10	11810	6,38
4,10	119	78	10	11684	3,26	7,75	165	109	10	11813	6,63

Ref. **1030**

BROCA MANGO CILÍNDRICO HSS LARGA

HSS Straight Shank Long Drill Bit
Foret queue cylindrique HSS longue



D mm	L mm	I mm		Nº Art.	€	D mm	L mm	I mm		Nº Art.	€
7,80	165	109	10	11816	7,14	11,80	195	128	1	11960	18,33
7,90	165	109	10	11819	7,14	11,90	205	134	1	11963	18,33
8,00	165	109	10	11822	6,90	12,00	205	134	1	11966	15,61
8,10	165	109	5	11825	7,14	12,20	205	134	1	11972	17,66
8,20	165	109	5	11828	7,14	12,25	205	134	1	11975	17,71
8,25	165	109	5	11831	7,41	12,30	205	134	1	11978	20,87
8,30	165	109	5	11834	10,97	12,50	205	134	1	11984	16,44
8,40	165	109	5	11837	10,97	12,75	205	134	1	11993	21,69
8,50	165	109	5	11840	7,67	13,00	205	134	1	12002	18,66
8,60	175	115	5	11843	10,97	13,25	214	140	1	12005	21,69
8,70	175	115	5	11846	10,97	13,50	214	140	1	12008	20,83
8,75	175	115	5	11849	11,42	13,75	214	140	1	12011	21,75
8,80	175	115	5	11852	11,21	14,00	214	140	1	12014	22,48
8,90	175	115	5	11855	11,21	14,25	220	144	1	12017	40,49
9,00	175	115	5	11858	8,34	14,50	220	144	1	12020	26,33
9,10	175	115	5	11861	11,21	14,75	220	144	1	12023	40,49
9,20	175	115	5	11864	11,21	15,00	220	144	1	12026	25,46
9,25	175	115	5	11867	11,66	15,25	227	149	1	12029	45,73
9,30	175	115	5	11870	12,08	15,50	227	149	1	12032	37,80
9,40	175	115	5	11873	12,08	15,75	227	149	1	12035	45,73
9,50	175	115	5	11876	8,45	16,00	227	149	1	12038	29,64
9,60	184	121	5	11879	12,08	16,25	235	154	1	12041	50,47
9,70	184	121	5	11882	12,08	16,50	235	154	1	12044	35,06
9,75	184	121	5	11885	12,53	16,75	235	154	1	12047	50,47
9,80	184	121	5	11888	12,08	17,00	235	154	1	12050	35,22
9,90	184	121	5	11891	12,08	17,25	241	158	1	12053	58,02
10,00	184	121	5	11894	9,13	17,50	241	158	1	12056	52,07
10,20	184	121	1	11900	12,33	17,75	241	158	1	12059	67,66
10,25	184	121	1	11903	11,42	18,00	241	158	1	12062	36,73
10,50	184	121	1	11912	12,33	18,25	247	162	1	12065	79,70
10,75	195	128	1	11921	12,53	18,50	247	162	1	12068	56,88
10,80	195	128	1	11924	15,68	(New) 18,75	247	162	1	12071	79,02
11,00	195	128	1	11930	13,71	19,00	247	162	1	12074	46,03
11,10	195	128	1	30588	18,33	(New) 19,25	254	166	1	12077	88,55
11,25	195	128	1	11939	16,29	19,50	254	166	1	12080	88,55
11,50	195	128	1	11948	13,97	19,75	254	166	1	12083	100,00
11,75	195	128	1	11957	18,33	20,00	254	166	1	12086	51,66



Ref. **1003**

BROCA MANGO CILÍNDRICO HSS LARGA

HSS Straight Shank Long Drill Bit
Foret queue cylindrique HSS longue



HSS

DIN
340 N



Serie Larga
Long Series
Série longue

Aceros
<850 N/mm²
Steel / Aciers

Fundición
Cast Iron
Fonte

Aluminio
Aluminium



D mm	L mm	I mm		Nº Art.	€
2,00	85	56	1	10572	2,76
2,50	95	62	1	10573	2,76
3,00	100	66	1	10581	2,57
3,25	106	69	1	10582	2,84
3,50	112	73	1	10584	2,59
4,00	119	78	1	10585	2,83
4,25	119	78	1	10591	3,68
4,50	126	82	1	10593	3,35
5,00	132	87	1	10596	3,59
5,50	139	91	1	10599	4,76
6,00	139	91	1	10602	4,42
6,50	148	97	1	10605	5,43
7,00	156	102	1	10608	6,36
7,50	156	102	1	10611	6,74
8,00	165	109	1	10614	7,55
8,50	165	109	1	10617	8,36
9,00	175	115	1	10620	9,07
10,00	184	121	1	10623	9,67
11,00	195	128	1	10629	14,51
12,00	205	134	1	10632	16,55
13,00	205	134	1	10635	19,78



Línea 1m 1003

BROCA MANGO CILÍNDRICO HSS LARGA

HSS Straight Shank Long Drill Bit
Foret queue cylindrique HSS longue



∅	2	2,5	3	3,25	3,5	4	4,25	4,5	5	5,5	6	6,5	7	7,5	8	8,5	9	10	12
Pcs	5	5	5	5	5	5	5	5	5	5	5	5	5	3	5	3	3	5	2

Ref. 4995 - N° Art. 71682: 431,30 €

Display 15

BROCA MANGO CILÍNDRICO HSS LARGA

HSS Straight Shank Long Drill Bit
Foret queue cylindrique HSS longue



∅	7,5	8	8,5	9	10	11	12	13		
Pcs	5	5	3	3	3	2	2	2		
∅	4,25	4,25	4,5	5	5	5,5	6	6	6,5	7
Pcs	3	2	5	3	2	3	3	2	5	5
∅	2	2,5	3	3	3,25	3,25	3,5	3,5	4	4
Pcs	5	5	3	2	3	2	3	2	3	2

Ref. 4995 - N° Art. 22328: 484,53 €

Ref. **1040**

BROCA MANGO CILÍNDRICO HSS EXTRA LARGA

HSS Straight Shank Extra Long Drill Bit
Foret queue cylindrique HSS extra-longue

IZAR
CUTTING TOOLS



HSS

DIN
1869 N



Serie Extra Larga
Extra Long Series
Série extra-longue

Aceros
<850 N/mm²
Steel / Aciers

Fundición
Cast Iron
Fonte

Aluminio
Aluminium



D mm	L mm	I mm		Nº Art.	€
2,00	125	85	1	12158	10,77
2,50	140	95	1	12161	11,25
3,00	150	100	1	12164	11,66
3,00	190	136	1	12167	13,47
3,50	165	115	1	12170	13,15
3,50	210	145	1	12173	15,16
3,50	265	180	1	12176	21,69
4,00	175	120	1	12179	13,15
4,00	220	150	1	12182	15,49
4,00	280	190	1	12185	22,10
4,50	185	125	1	12188	14,58
4,50	235	160	1	12191	18,19
4,50	295	200	1	12194	26,04
5,00	195	135	1	12197	15,39
5,00	245	170	1	12200	19,57
5,00	315	210	1	12203	24,05
5,50	205	140	1	12206	18,22
5,50	260	180	1	12209	26,04
5,50	330	225	1	12212	30,05
6,00	205	140	1	12215	18,22
6,00	260	180	1	12218	26,04
6,00	330	225	1	12221	30,05
6,50	215	150	1	12224	21,69
6,50	275	190	1	12227	27,99

D mm	L mm	I mm		Nº Art.	€
6,50	350	235	1	12230	34,87
7,00	225	155	1	12233	22,96
7,00	290	200	1	12236	31,98
7,00	370	250	1	12239	43,23
7,50	225	155	1	12242	25,86
7,50	290	200	1	12245	34,45
7,50	370	250	1	12248	50,19
8,00	240	165	1	12251	28,57
8,00	305	210	1	12254	39,58
8,00	390	265	1	12257	51,57
8,50	240	165	1	12260	38,89
8,50	305	210	1	12263	52,99
8,50	390	265	1	12266	72,88
9,00	250	175	1	12269	37,07
9,00	320	220	1	12272	48,96
9,00	410	280	1	12275	71,89
9,50	250	175	1	12278	43,68
9,50	320	220	1	12281	60,03
9,50	410	280	1	12284	80,87
10,00	265	185	1	12287	43,10
10,00	340	235	1	12290	56,39
10,00	430	295	1	12293	78,34
11,00	280	195	1	28866	54,57
12,00	295	205	1	28867	72,05



Ref. **1090**

BROCA MANGO CILÍNDRICO HSS LAMINADA

HSS Straight Shank Rolled Drill Bit
Foret queue cylindrique HSS laminé



HSS

Laminada
Rolled
Laminé



D mm	L mm	I mm		Nº Art.	€
1,00	34	12	10	21440	0,32
1,50	40	18	10	21446	0,32
2,00	49	24	10	21452	0,32
2,50	57	30	10	21458	0,32
3,00	61	33	10	21464	0,32
3,25	65	36	10	21470	0,39
3,50	70	39	10	21473	0,45
4,00	75	43	10	21482	0,45

D mm	L mm	I mm		Nº Art.	€
4,25	75	43	10	21485	0,53
4,50	80	47	10	21488	0,53
5,00	86	52	10	21494	0,56
5,50	93	57	10	21503	0,63
6,00	93	57	10	21509	0,66
6,50	101	63	10	21518	0,71
7,00	109	69	10	21527	1,01
7,50	109	69	10	21533	1,07

D mm	L mm	I mm		Nº Art.	€
8,00	117	75	10	21542	1,17
8,50	117	75	10	21548	1,36
9,00	125	81	10	21554	1,70
10,00	133	87	10	21566	1,84
11,00	142	94	5	21581	2,35
12,00	151	101	5	21593	2,59
13,00	151	101	5	21608	3,03

Ref. **1009**

BROCA MANGO CILÍNDRICO HSS LAMINADA

HSS Straight Shank Rolled Drill Bit
Foret queue cylindrique HSS laminé



HSS

Laminada
Rolled
Laminé



D mm	L mm	I mm		Nº Art.	€
1,00	34	12	2	30173	0,88 *
1,50	40	18	2	30175	0,88 *
2,00	49	24	2	30177	0,91 *
2,50	57	30	2	30179	0,91 *
3,00	61	33	2	30181	0,91 *
3,25	65	36	2	30182	1,04 *
3,50	70	39	2	30183	1,11 *
4,00	75	43	2	30185	1,11 *

D mm	L mm	I mm		Nº Art.	€
4,25	75	43	1	30186	0,73
4,50	80	47	1	30187	0,81
5,00	86	52	1	30189	0,81
5,50	93	57	1	30191	0,88
6,00	93	57	1	30193	0,95
6,50	101	63	1	30195	1,00
7,00	109	69	1	30197	1,11
7,50	109	69	1	30199	1,29

D mm	L mm	I mm		Nº Art.	€
8,00	117	75	1	30201	1,47
8,50	117	75	1	30203	1,65
9,00	125	81	1	30205	1,75
10,00	133	87	1	30209	2,17
11,00	142	94	1	30213	2,80
12,00	151	101	1	30217	3,41
13,00	151	101	1	30221	3,77

* € = 2 uds.



Set **1490**

6 Pcs

Cont. Ø	Nº Art.	€
2 - 3 - 4 - 5 - 6 - 8 mm	30204	4,77



Set **1491**

19 Pcs

Cont. Ø	Nº Art.	€
1 - 10 x 0,5 mm	30206	18,98



Set **1492**

25 Pcs

Cont. Ø	Nº Art.	€
1 - 13 x 0,5 mm	30210	38,11



Set **1499**

170 Pcs

Cont. Ø	Nº Art.	€
1-10 x 0,5 mm Ø 1-8: 10 pcs/Ø Ø 8,5-10: 5 pcs/Ø	69084	130,41



Ref. **1110**

BROCA MANGO CÓNICO HSS

HSS Morse Taper Shank Drill Bit
Foret queue cône morse HSS



HSS

DIN
345 N

118°

(ø14÷ø40)

Aceros
<850 N/mm²
Steel / Aciers

Aceros
<1000 N/mm²
Steel / Aciers

Fundición
Cast Iron
Fonte

Cobre
Copper
Cuivre



D	L	I	CM	N° Art.	€	D	L	I	CM	N° Art.	€	D	L	I	CM	N° Art.	€
mm	mm	mm				mm	mm	mm				mm	mm	mm			
5,00	133	52	1	14426	13,92	16,50	223	125	2	14564	30,37	28,00	291	170	3	14702	76,44
5,25	133	52	1	14429	16,01	16,75	223	125	2	14567	34,94	28,25	296	175	3	14705	94,27
5,50	138	57	1	14432	13,92	17,00	223	125	2	14570	30,37	28,50	296	175	3	14708	81,96
5,75	138	57	1	14435	16,01	17,25	228	130	2	14573	38,65	28,75	296	175	3	14711	94,27
6,00	138	57	1	14438	13,92	17,50	228	130	2	14576	33,60	29,00	296	175	3	14714	81,96
6,25	144	63	1	14441	18,24	17,75	228	130	2	14579	38,65	29,25	296	175	3	14717	103,65
6,50	144	63	1	14444	14,81	18,00	228	130	2	14582	32,33	29,50	296	175	3	14720	90,12
6,75	150	69	1	14447	17,03	18,25	233	135	2	14585	42,53	29,75	296	175	3	14723	103,65
7,00	150	69	1	14450	14,81	18,50	233	135	2	14588	36,99	30,00	296	175	3	14726	90,12
7,25	150	69	1	14453	19,59	18,75	233	135	2	14591	42,53	30,25	301	180	3	14729	115,34
7,50	150	69	1	14456	15,93	19,00	233	135	2	14594	36,99	30,50	301	180	3	14732	100,29
7,75	156	75	1	14459	19,59	19,25	238	140	2	14597	46,29	30,75	301	180	3	14735	115,34
8,00	156	75	1	14462	15,88	19,50	238	140	2	14600	40,25	31,00	301	180	3	14738	100,29
8,25	156	75	1	14465	22,99	19,75	238	140	2	14603	46,29	31,25	301	180	3	14741	122,14
8,50	156	75	1	14468	17,27	20,00	238	140	2	14606	40,25	31,50	301	180	3	14744	106,20
8,75	162	81	1	14471	20,66	20,25	243	145	2	14609	47,99	31,75	306	185	3	14747	122,14
9,00	162	81	1	14474	17,27	20,50	243	145	2	14612	41,73	32,00	334	185	4	14750	106,20
9,25	162	81	1	14477	22,85	20,75	243	145	2	14615	47,99	32,50	334	185	4	14753	121,32
9,50	162	81	1	14480	17,06	21,00	243	145	2	14618	41,73	33,00	334	185	4	14756	121,32
9,75	168	87	1	14483	22,85	21,25	248	150	2	14621	52,94	33,50	334	185	4	14759	131,91
10,00	168	87	1	14486	16,75	21,50	248	150	2	14624	46,01	34,00	339	190	4	14762	131,91
10,25	168	87	1	14489	21,39	21,75	248	150	2	14627	52,94	34,50	339	190	4	14765	144,14
10,50	168	87	1	14492	18,58	22,00	248	150	2	14630	46,01	35,00	339	190	4	14768	144,14
10,75	175	94	1	14495	21,39	22,25	248	150	2	14633	57,92	35,50	339	190	4	14771	154,66
11,00	175	94	1	14498	18,58	22,50	253	155	2	14636	50,37	36,00	344	195	4	14774	154,66
11,25	175	94	1	14501	22,49	22,75	253	155	2	14639	57,92	36,50	344	195	4	14777	163,03
11,50	175	94	1	14504	19,57	23,00	253	155	2	14642	50,37	37,00	344	195	4	14780	163,03
11,75	175	94	1	14507	22,49	23,25	276	155	3	14645	63,91	37,50	344	195	4	14783	171,48
12,00	182	101	1	14510	19,57	23,50	276	155	3	14648	55,57	38,00	349	200	4	14786	171,48
12,25	182	101	1	14513	25,04	23,75	281	160	3	14651	63,91	38,50	349	200	4	14789	182,88
12,50	182	101	1	14516	20,95	24,00	281	160	3	14654	55,57	39,00	349	200	4	14792	182,88
12,75	182	101	1	14519	25,04	24,25	281	160	3	14657	69,71	39,50	349	200	4	14795	193,10
13,00	182	101	1	14522	21,79	24,50	281	160	3	14660	60,59	40,00	349	200	4	14798	193,10
13,25	189	108	1	14525	27,55	24,75	281	160	3	14663	69,71	40,50	354	205	4	14801	203,05
13,50	189	108	1	14528	23,01	25,00	281	160	3	14666	60,59	41,00	354	205	4	14804	203,05
13,75	189	108	1	14531	27,55	25,25	286	165	3	14669	75,83	41,50	354	205	4	14807	215,46
14,00	189	108	1	14534	23,01	25,50	286	165	3	14672	65,92	42,00	354	205	4	14810	215,46
14,25	212	114	2	14537	29,83	25,75	286	165	3	14675	75,83	42,50	354	205	4	14813	226,01
14,50	212	114	2	14540	25,96	26,00	286	165	3	14678	65,92	43,00	359	210	4	14816	226,01
14,75	212	114	2	14543	29,83	26,25	286	165	3	14681	82,10	43,50	359	210	4	14819	236,61
15,00	212	114	2	14546	25,96	26,50	286	165	3	14684	71,40	44,00	359	210	4	14822	236,61
15,25	218	120	2	14549	30,89	26,75	291	170	3	14687	82,10	44,50	359	210	4	14825	247,05
15,50	218	120	2	14552	26,85	27,00	291	170	3	14690	71,40	45,00	359	210	4	14828	247,05
15,75	218	120	2	14555	30,89	27,25	291	170	3	14693	87,87	45,50	364	215	4	14831	257,48
16,00	218	120	2	14558	26,85	27,50	291	170	3	14696	76,44	46,00	364	215	4	14834	257,48
16,25	223	125	2	14561	34,94	27,75	291	170	3	14699	87,87	46,50	364	215	4	14837	267,95

Ref. **1110**

BROCA MANGO CÓNICO HSS

HSS Morse Taper Shank Drill Bit
Foret queue cône morse HSS

D mm	L mm	I mm	CM	Nº Art.	€
47,00	364	215	4	14840	267,95
47,50	364	215	4	14843	276,97
48,00	369	220	4	14846	276,97
48,50	369	220	4	14849	287,60
49,00	369	220	4	14852	287,60
49,50	369	220	4	14855	298,05
50,00	369	220	4	14858	298,05
51,00	412	225	5	14864	351,85
52,00	412	225	5	14867	375,13
53,00	412	225	5	14870	400,28
54,00	417	230	5	14873	442,62
55,00	417	230	5	14876	436,74
56,00	417	230	5	14879	492,98
57,00	422	235	5	14882	521,65
58,00	422	235	5	14885	524,90
59,00	422	235	5	14888	541,81
60,00	422	235	5	14891	515,14
61,00	427	240	5	14894	602,95
62,00	427	240	5	14897	627,99
63,00	427	240	5	14900	664,11

D mm	L mm	I mm	CM	Nº Art.	€
64,00	432	245	5	14903	700,69
65,00	432	245	5	14906	672,91
66,00	432	245	5	14909	756,28
67,00	432	245	5	14912	780,70
68,00	437	250	5	14915	800,96
69,00	437	250	5	14918	825,82
70,00	437	250	5	14921	783,01

>70 mm bajo demanda
upon request / sur demande

71,00	437	250	5	14924	904,01
72,00	442	255	5	14927	922,74
73,00	442	255	5	14930	946,91
74,00	442	255	5	14933	974,60
75,00	442	255	5	14936	918,03
76,00	447	260	5	14939	1.081,02
77,00	514	260	6	14942	1.160,06
78,00	514	260	6	14945	1.182,72
79,00	514	260	6	14948	1.206,53
80,00	514	260	6	14951	1.272,88

D mm	L mm	I mm	CM	Nº Art.	€
81,00	519	265	6	14954	1.401,45
82,00	519	265	6	14957	1.436,46
83,00	519	265	6	14960	1.464,03
84,00	519	265	6	14963	1.495,11
85,00	519	265	6	14966	1.532,05
86,00	524	270	6	14969	1.565,49
87,00	524	270	6	14972	1.598,77
88,00	524	270	6	14975	1.639,85
89,00	524	270	6	14978	1.671,56
90,00	524	270	6	14981	1.719,44
91,00	529	275	6	14984	1.813,50
92,00	529	275	6	14987	1.823,93
93,00	529	275	6	14990	1.888,99
94,00	529	275	6	14993	1.927,39
95,00	529	275	6	14996	1.966,99
96,00	534	280	6	14999	2.031,81
97,00	534	280	6	15002	2.048,83
98,00	534	280	6	15005	2.094,53
99,00	534	280	6	15008	2.132,41
100,00	534	280	6	15011	2.173,07



Set 25 Pcs

Cont. Ø	Nº Art.	€
14-14,5-15-15,5-16-16,5-17-17,5-18-18,5-19-19,5-20-20,5-21-21,5-22-22,5-23-24-25-26-27-28-30 mm	14263	1.224,06



Set 10 Pcs

Cont. Ø	Nº Art.	€
14-15-16-17-18-19-20-21-22-25 mm	19346	410,21

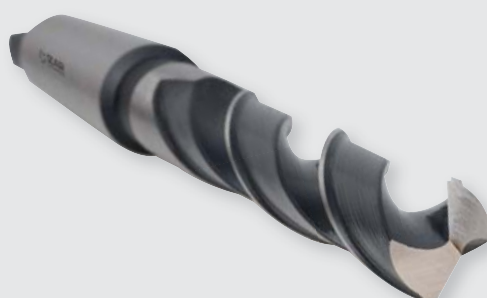

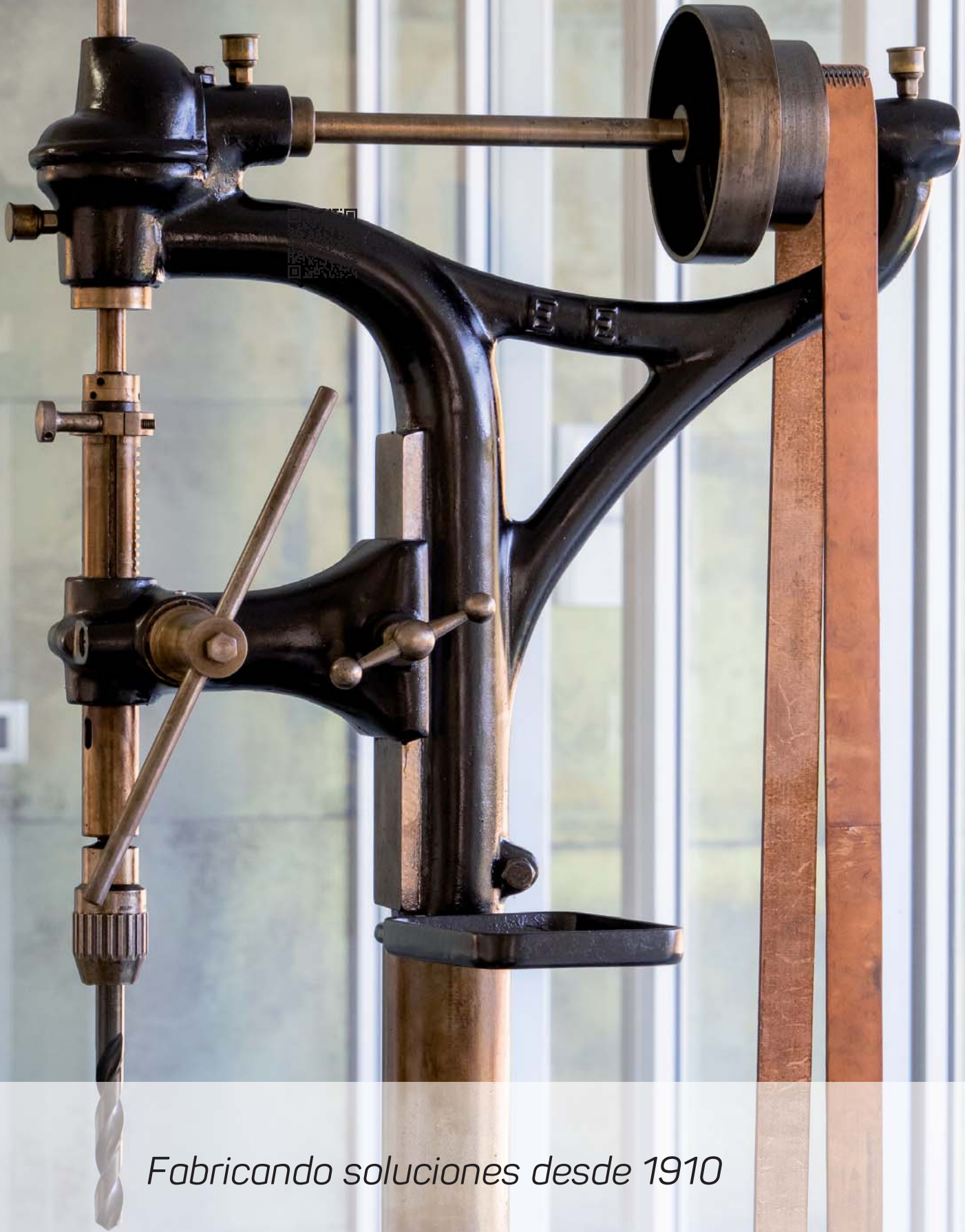

Fabricando soluciones desde 1910

izartool.com

PORTABROCAS Y ACCESORIOS

Drill Chucks & Accessories

Mandrins et accessoires

Ref. **1802**

PORTABROCAS TALADROS PORTÁTILES CON LLAVE

Portable Drilling Machine Metal Drill-Chucks with Key

Mandrins métal perceuses portables avec clé



Mod. Monoblock

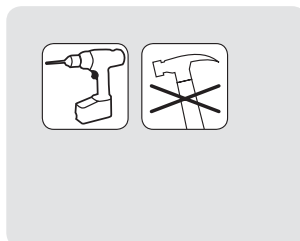

- 1 única pieza
- Elimina roturas de dientes
- Ideal taladro portátil
- Cierre con llave
- Cuerpo metal
- Agujero interior
- Only one piece
- No teeth breaking
- Ideal portable drills
- Key-lock
- Metal body
- Internal hole
- 1 Seule pièce
- Pas de casse de dents
- Perceuses à main
- Fermeture à clé
- Corps Métal
- Trou intérieur

Monoblock

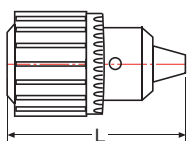

Mod.	Cap. mm	Fijación Fix.	L mm	Peso Weight Poids gr.	Nº Art.	€
00102	1-10	1/2X20 UNF	60	299	47491	18,16
00131	1,5-13	3/8X24 UNF	77	501	47493	20,06

2 Pcs.

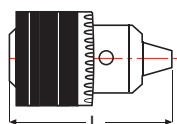

Mod.	Cap. mm	Fijación Fix.	L mm	Peso Weight Poids gr.	Nº Art.	€
00101	1-10	3/8X24 UNF	60	311	47490	18,16
00132	1,5-13	1/2X20 UNF	77	492	47494	20,06

Ref. **1807**

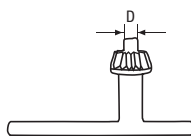

D mm	Mod.	Nº Art.	€
6	00102		
	00101	16362	3,25
	00132		
6,3	00131	69316	3,86



Ref. **1806**

PORTABROCAS TALADROS PORTÁTILES - AUTOMÁTICO METAL

Portable Drilling Machine Drill-Chucks - Metal Automatic
Mandrins perceuses portables - automatique métal



Reversible

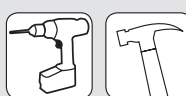

- | | | |
|----------------------------------|------------------------------------|--------------------------------------|
| - Cierre seguridad | - Security lock | - Fermeture sureté |
| - Capacidad 13: Garras MD | - Capacity 13: carbide jaws | - Capacité 13: pinces carbure |
| - Ideal atornilladores | - Ideal screwdrivers | - Idéal Tournevis |
| - Taladros percusión de batería | - Battery percussion drills | - Perceuses percussion batterie |
| - Reversible | - Reversible | - Reversible |
| - Cuerpo metal ligero | - Light metal body | - Corps métal léger |
| - Agujero interior | - Internal hole | - Trou intérieur |
| - No apto martillos SDS | - Not suitable SDS | - Non apte pour SDS |

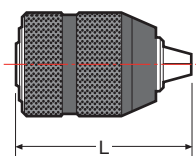

Mod.	Cap. mm	Fijación Fix.	L mm	Peso Weight Poids gr.	Nº Art.	€
00101	1-10	3/8X24 UNF	64,5	311	14706	42,50
00102	1-10	1/2x20 UNF	64,5	313	14712	42,50
00131	2-13	3/8X24 UNF	74,5	397	14718	61,27
00132	2-13	1/2X20 UNF	74,5	328	14736	61,27

Ref. **1804**

PORTABROCAS TALADROS PORTATILES Y ESTACIONARIOS

Portable & Stationary Drilling Machine Drill-Chucks
Mandrins perceuses portables et fixes



Derecha Right - Droite



SDS plus



- | | | |
|--|---|--|
| - Cierre seguridad | - Security lock | - Fermeture sureté |
| - Taladros industriales y percusión (aptos martillos alta frecuencia SDS plus) | - Industrial & percussion drills (suitable high frequency hammers SDS plus) | - Perceuses industrielles et précisions (aptos pour marteaux haute fréquence SDS plus) |
| - Autoapriete automático | - Automatic self-tightening | - Auto-attachement |

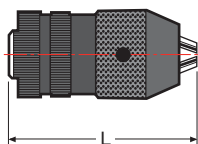

Mod.	Cap. mm	Fijación Fix.	L mm	Peso Weight Poids gr.	Nº Art.	€
00101	0-10	3/8X24 UNF	74	350	16358	76,45
00102	0-10	1/2x20 UNF	77	593	16359	76,45
00132	1-13	1/2X20 UNF	96	670	16361	82,32

Ref. **1803**

PORTABROCAS PRECISIÓN TALADROS PORTATILES Y ESTACIONARIOS

Portable & Stationary Drilling Machine Precision Drill-Chucks

Mandrins précision perceuses portables et fixes

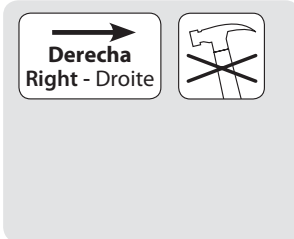

- Uso Taladros industriales y profesionales
- Fijaciones: Rosca taladro portátil y Cónica taladro fijo
- Autoapriete automático
- Giro a derechas

- Use for Industrial & professional drills
- Fixing: Threaded portable drills & Tapered for fixed drills
- Automatic self-tightening
- Right turning

- Usage perceuses industrielles et professionnelles
- Fixations: Filet perceuse portable et conique perceuse à colonne
- Amenchement automatique
- Tour à droite

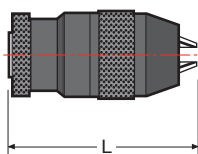

Mod.	Cap. mm	Fijación Fix.	L mm	Peso Weight Poids gr.	Nº Art.	€	Garras Jaws Pincas Art.
00101	0,8-10	B12 *	86	619	16349	69,53	56894
00102	0,8-10	3/8X24 UNF	78	451	16350	69,53	56894
00103	0,8-10	1/2X20UNF	78	452	16351	69,53	56894
00131	1-13	B16 *	103	800	16352	74,84	24565
00132	2-13	3/8X24 UNF	83	764	16353	74,84	56894
00133	2-13	1/2X20 UNF	83	583	16354	74,84	56894
00161	3-16	B16	105	1.180	16355	127,33	24565
00162	3-16	B18 *	105	1.152	16356	127,33	24565
00163	3-16	1/2X20 UNF	105	1.185	16357	127,33	24565
00164	5-20	B18 *	131	2.165	19957	160,71	24566

*** RECOMENDACIONES:**

1. Limpiar muy bien la espiga y el agujero del portabrocas antes de introducir la espiga.
2. Cogiendo el porta-brocas en una mano, insertar la espiga con la otra mano.
3. Dar un pequeño golpe seco con una maza de Nylon.

*** RECOMMENDATIONS:**

1. Thoroughly clean the spindle and the chuck-hole before inserting the spindle.
2. Holding the chuck in one hand, insert the spike with the other hand.
3. Give a small heavy thud with a Nylon mace.

*** RECOMMANDATIONS :**

1. Nettoyez soigneusement l'arbre d'attache et le trou du mandrin avant d'insérer l'arbre.
2. En tenant le mandrin d'une main, insérez l'arbre avec l'autre main.
3. Donnez un petit coup sec avec une masse en nylon.

Ref. **1809**

ACCESORIOS

Accessories
Accessoires



00001



00002



00003



00004



00005



00008



00021



00010



00011



Conversores / Converters / Convertisseurs

Mod.	Entrada Inlet Entrée	Fijación Fix	Nº Art.	€
00001	3/8X24h	3/8X24h	16363	3,77
00002	3/8X24h	1/2X20h	16364	4,42
00003	SDS plus	1/2X20h	16365	20,92
00004	SDS max	SDS plus	17258	119,70
00005	Hex. 13 mm	SDS plus	17259	129,79
00008	1/2x20h	SDS plus	20485	64,77
New! 00021	Hexagonal	M14	24273	11,75

Tornillos / Screws / Vis

Mod.	Entrada Inlet Entrée	Fijación Fix		Nº Art.	€
00010	M5x18 mm	3/8x24	1	25321	0,42
00011	M6x25 mm	1/2x20	1	25323	0,42

Ref. **1819**

GARRAS

Jaws
Pinces

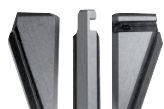

Mod.	Garras Jaws Pinces	Nº Art.	€
1013ROS	10/13 mm ROSCA (Ref. 1803)	56894	36,96
13DIN16	13DIN / 16 mm (Ref. 1803)	24565	38,91
16	16 mm	24566	39,35



Display 12



PORTABROCAS TALADROS PORTATILES Y ESTACIONARIOS

Portable & Stationary Drilling Machine Drill-Chucks
Mandrins perceuses portables et fixes

∅	Ref. 1802 Cap. 1-10 Fix. 1/2 x 20h	Ref. 1802 Cap. 1,5-13 Fix. 1/2 x 20h	Ref. 1806 Cap. 1-10 Fix. 1/2 x 20h	Ref. 1806 Cap. 1-10 Fix. 1/2 x 20h	Ref. 1806 Cap. 2-13 Fix. 1/2 x 20h	Ref. 1806 Cap. 2-13 Fix. 1/2 x 20h
Pcs	2	2	1	1	1	1
∅	Ref. 1803 Cap. 0,8-10 Fix. 1/2 x 20h	Ref. 1803 Cap. 2-13 Fix. 1/2 x 20h	Ref. 1804 Cap. 1-13 Fix. 1/2 x 20h	Ref. 1804 Cap. 1-13 Fix. 1/2 x 20h	Ref. 1809 SDS plus Mod. 00003	Ref. 1807 Llave Key - Clé D 6 mm
Pcs	2	2	1	1	5	5

Ref. 4995 - Nº Art. 22334: 858,24 €

Línea 1m 18PB



PORTABROCAS TALADROS PORTATILES Y ESTACIONARIOS

Portable & Stationary Drilling Machine Drill-Chucks
Mandrins perceuses portables et fixes

∅	Ref. 1802 Cap. 1-10 Fix 1/2 x 20h	Ref. 1802 Cap. 1,5-13 Fix 1/2 x 20h	Ref. 1803 Cap. 0,8-10 Fix 1/2 x 20h	Ref. 1803 Cap. 2-13 Fix 1/2 x 20h	Ref. 1804 Cap. 1-13 Fix 1/2 x 20h	Ref. 1804 Cap. 1-13 Fix 1/2 x 20h	Ref. 1806 Cap. 1-10 Fix 1/2 x 20h	Ref. 1806 Cap. 2-13 Fix 1/2 x 20h	Ref. 1807 Llave Key - Clé D 6 mm	Ref. 1809 SDS plus Fix 1/2 x 20h
Pcs	2	2	2	2	1	1	2	2	3	5

Ref. 4995 - Nº Art. 72080: 851,73 €

Línea 33 cm 18PB



PORTABROCAS TALADROS PORTATILES Y ESTACIONARIOS

Portable & Stationary Drilling Machine Drill-Chucks
Mandrins perceuses portables et fixes

∅	Ref. 1802 Cap. 1,5-13 Fix 1/2 x 20h	Ref. 1803 Cap. 0,8-10 Fix 1/2 x 20h	Ref. 1803 Cap. 2-13 Fix 1/2 x 20h	Ref. 1806 Cap. 1-10 Fix. 1/2 x 20h	Ref. 1806 Cap. 2-13 Fix 1/2 x 20h
Pcs	2	2	2	2	2

Ref. 4995 - Nº Art. 72081: 536,38 €

Ref. **1101**

CONO REDUCTOR

Reduction Sleeve
Douille de réduction



HSS

DIN
2185

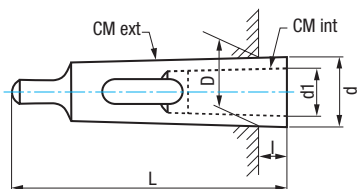

CM EXT.	CM INT.	L mm	I mm	D mm	d1 mm	d mm	Nº Art.	€
2	1	92	17,00	17,780	12,065	18,60	16415	18,82
3	1	99	5,00	23,825	12,065	24,10	16416	25,79
3	2	112	18,00	23,825	17,780	24,70	16417	26,16
4	1	124	6,50	31,267	12,065	31,60	16418	41,06
4	2	124	6,50	31,267	17,780	31,60	16419	41,06
4	3	140	22,50	31,267	23,825	32,40	16420	41,06
5	3	156	6,50	44,399	23,825	44,70	16421	63,15
5	4	171	21,50	44,399	31,267	45,50	16422	63,40



Ref. **1102**

ALARGADOR CONOS

Extension Socket
Douille d'augmentation



HSS

DIN
2187

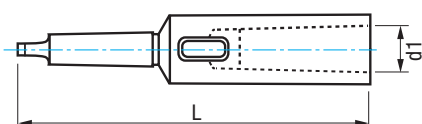

CM EXT.	CM INT.	L mm	d1 mm	Nº Art.	€
1	2	160	17,78	16423	45,50
2	1	159	12,07	16427	35,23
2	2	176	17,78	16433	46,65
2	3	195	23,83	16424	60,09
3	1	176	12,07	16428	37,58
3	2	194	17,78	16429	44,31
3	3	215	23,83	16434	67,89
3	4	239	31,27	16425	90,14
4	1	200	12,07	16430	62,86
4	2	215	17,78	16431	63,55
4	3	240	23,83	16432	74,02
4	4	265	31,27	16435	106,96
4	5	299	44,39	16426	211,79



Ref. **1103**

ESPIGA SUJECIÓN

Spike CM Taper
Arbre d'attachement



HSS

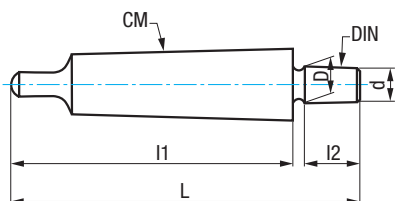

CM	DIN	L mm	l1 mm	D mm	d mm	l2 mm		Nº Art.	€
1	B12	89,00	62,00	12,065	11,10	18,50	1	16440	11,88
2	B12	106,00	75,00	12,065	11,10	18,50	1	16441	12,83
2	B16	111,00	75,00	15,733	14,50	24,00	1	16442	12,83
2	B18	118,00	75,00	17,780	16,20	32,00	1	16443	12,83
3	B12	126,00	94,00	12,065	11,10	18,50	1	16444	15,59
3	B16	134,00	94,00	15,733	14,50	24,00	1	16445	15,59
3	B18	140,00	94,00	17,780	16,20	32,00	1	21873	15,59
4	B16	158,00	117,50	15,733	14,50	24,00	1	16446	23,93
4	B18	166,50	117,50	17,780	16,20	32,00	1	16447	23,93
5	B16	194	149,50	15,733	14,50	24,00	1	66764	68,22
5	B18	202	149,50	17,780	16,20	32,00	1	66765	68,22



Ref. **1104**

CUÑA EXPULSORA

Drill Drift
Chasse cône standard



HSS

CM Ext. min.	CM Ext. max.	L mm		Nº Art.	€
1	2	116	1	16436	11,23
2	3	150	1	16437	13,57
3	4	199	1	16438	17,99
4	5	251	1	16439	24,30



Ref. **9994**

MÁQUINA AFILADORA BROCAS

Drill Bit Sharpening Machine
Machine affûteuse forets



Mod. **XP**



Cap. mm	Punta Point Pointe	Uso Use Usage	Nº Art.	€
2,5-13	118°	HSS, TIN, HSSE, MD / HM / Carbure, Pared / Masonry / Béton + Split Point	38416	161,01

Incluida Muela y medidor de ángulos
Wheel & Angle Meter included
Compris meule et compteur d'angle



Mod. **500**



Cap. mm	Punta Point Pointe	Uso Use Usage	Nº Art.	€
2,5-13	118°-135°	HSS, TIN, HSSE, MD / HM / Carbure, Pared / Masonry / Béton + Split Point	45121	327,38

Incluida Muela K180 y medidor de ángulos
Wheel K180 & Angle Meter included
Compris meule K180 et compteur d'angle



Mod. **750**



Cap. mm	Punta Point Pointe	Uso Use Usage	Nº Art.	€
2,5-19	115°-140°	HSS, TIN, HSSE, MD / HM / Carbure, Pared / Masonry / Béton + Split Point	38418	374,84

Incluida Muela K180 y medidor de ángulos
Wheel K180 & Angle Meter included
Compris meule K180 et compteur d'angle



* INSTRUCCIONES USO / Directions for use / Instructions d'emploi

PIEZAS RECAMBIO - Spare Parts - Pieces rechange

Porta Brocas - Drill Chucks - Mandrins

Muela - Wheel - Meule

Mod.	Cap. mm	Punta Point Pointe	Nº Art.	€
XP	2,5-13	118°	39712	74,47
500	2,5-13	118°-135°	47218	74,47
500-750	2,5-19	115°-140°	40343	104,42

Mod.	Grano Grain	Máquina Machine	Cap. mm	Nº Art.	€
K180	Fino Fine Fin	XP-500-750	2,5-19	40344	52,11
K100	Gruoso Coarse Gros	750	13-19	43414	52,11

BROCAS ESPECIALES

Special Drill Bits

Forets Spéciales

Ref. **1602**

BROCA ESCALONADA HSS

HSS Step Drill Bit
Foret étagé HSS



- Nueva punta robusta autocentrante
- Avellanado especial 45°
- Menor desgaste y esfuerzo de corte
- Mayor rendimiento y vida útil de la herramienta
- Mejor evacuación de viruta
- Acabado sin rebabas

- New autocentering robust point
- Special 45° Countersinking
- Lower wear and cutting effort
- Better performance & longer tool life
- Better chipping-off
- No-burr finishing

- Nouvelle pointe plus robuste autocentrante
- Ébavurage spécial à 45°
- Réduction de l'usure et de l'effort de coupe
- Augmentation de la performance et vie utile de l'outil
- Meilleure évacuation des copeaux
- Finition sans bavures

HSS

118°

45°

< 4 mm

Chapa
Sheets
Tôle

Materiales ferrosos
Ferrous Materials
Matériaux ferreux

Aceros
<850 N/mm²
Steel / Aciers

Plásticos
Plastics
Plastiques



Cap. mm	Nº Pasos Steps / Étages	d mm	L mm	Nº Art.	€
4-12	9 (4-5-6-7-8-9-10-11-12)	6	79	12048	40,61
4-20	9 (4-6-8-10-12-14-16-18-20)	9	67	12054	51,63
4-30	14 (4-6-8-10-12-14-16-18-20-22-24-26-28-30)	10	100	66484	68,30
6-30	13 (6-8-10-12-14-16-18-20-22-24-26-28-30)	10	100	12060	75,89
7-37	8 (7-12,5-15,2-18,6-20,4-22,5-28,3-37)	12	90	67619	148,04
9-36	10 (9-12-15-18-21-24-27-30-33-36)	12	82	12066	136,52
12-20	9 (12-13-14-15-16-17-18-19-20)	9	75	56798	56,31
20-30	11 (20-21-22-23-24-25-26-27-28-29-30)	12	88	56799	82,09
30-40	11 (30-31-32-33-34-35-36-37-38-39-40)	13	98	60715	123,23
40-50	11 (40-41-42-43-44-45-46-47-48-49-50)	13	112	60716	190,99
50-60	11 (50-51-52-53-54-55-56-57-58-59-60)	13	120	60717	285,77



Set 3 Pcs

Cont.	Nº Art.	€
4-12, 4-20, 6-30 mm	43518	168,13

Expo
1602

EXPOSITOR BROCAS ESCALONADAS

Step Drill Display
Présentoirs forets étagés

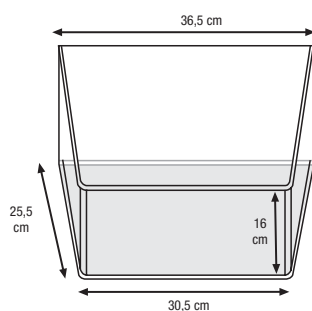

15 Pcs

Nº Art. €

65184 1.486,06

Cap. mm	Nº Art.	Uds.
4-12	12048	2
4-20	12054	2
6-30	12060	2
9-36	12066	2
12-20	56798	2
20-30	56799	2
30-40	60715	1
40-50	60716	1
50-60	60717	1

Línea 33 cm
1602

BROCA ESCALONADA HSS

HSS Step Drill Bit
Foret étagé HSS



ø	4-12	4-20	4-30	6-30	9-36	12-20
Pcs	1	1	1	1	1	1

Ref. 4995 - Nº Art. 70954: 429,25 €



Ref. **1612**

BROCA ESCALONADA **ESPIRAL** HSS

HSS **Spiral** Step Drill Bit
Foret étagé **spirale** HSS



- Canal optimizado para virutas largas y complejas
- Avellanado especial 45°
- Filos de corte protegidos y muy afilados
- Sin rebabas
- Mayor vida útil en materiales muy duros
- Autocentrado en chapas finas
- Optimized channel for long and complex chips
- Special 45° Countersinking
- Very sharpened & protected cutting edges
- No burrs
- Longer tool life in very hard materials
- Autocentering in fine sheets
- Goujure optimisée pour copeaux longs et complexes
- Ébavurage special à 45°
- Filets des arêtes de coupe protégés et plus affûtés
- Sans bavures
- Vie utile plus longue pour aciers plus durs
- Autocentrage sur toles minces

HSS



Chapa
Sheets
Tôle

Materiales ferrosos
Ferrous Materials
Matériaux ferreux



Aceros
<850 N/mm²
Steel / Aciers

Plásticos
Plastics
Plastiques

Cap. mm	Nº Pasos Steps / Étages	d mm	L mm	Nº Art.	€
4-12	9 (4-5-6-7-8-9-10-11-12)	6	80	67360	42,26
4-20	9 (4-6-8-10-12-14-16-18-20)	9	69	67366	59,97
6-30	13 (6-8-10-12-14-16-18-20-22-24-26-28-30)	10	99	67368	87,22
6-38	12 (6-9-13-16-19-21-23-26-29-32-35-38)	12	97	69557	171,53



Set 3 Pcs

Cont.	Nº Art.	€
4-12, 4-20, 6-30 mm	67357	189,45

Línea 33 cm
1612

BROCA ESCALONADA **ESPIRAL** HSS

HSS **Spiral** Step Drill Bit
Foret étagé **spirale** HSS



∅	4-12	4-20	6-30	6-38
Pcs	1	1	1	1

Ref. 4995 - Nº Art. 70958: 360,98 €

Ref. **1607**

BROCA ESCALONADA HSSE INOX

Stainless HSSE Step Drill Bit
Foret étagé HSSE Inox



- Nueva punta robusta autocentrante
- Avellanado especial 45°
- Menor desgaste y esfuerzo de corte
- Mayor rendimiento y vida útil de la herramienta
- Mejor evacuación de viruta
- Acabado sin rebabas
- New autocentering robust point
- Special 45° Countersinking
- Lower wear and cutting effort
- Better performance & longer tool life
- Better chipping-off
- No-burr finishing
- Nouvelle pointe plus robuste autocentrante
- Ébavurage special à 45°
- Réduction de l'usure et de l'effort de coupe
- Augmentation de la performance et vie utile de l'outil
- Meilleure évacuation des copeaux
- Finition sans bavures

HSSE
5% Co

118°

45°

< 4 mm

Chapa
Sheets
Tôle

Materiales ferrosos
Ferrous Materials
Matériaux ferreux

Aceros
<850 N/mm²
Steel / Aciers

INOX
Stainless Steel
Acier INOX

Cobre
Copper
Cuivre

Aluminio
Aluminium

Plásticos
Plastics
Plastiques



Cap. mm	Nº Pasos Steps / Étages	d mm	L mm	Nº Art.	€
4-12	9 (4-5-6-7-8-9-10-11-12)	6	79	12072	48,72
4-20	9 (4-6-8-10-12-14-16-18-20)	8	67	12078	61,97
6-30	13 (6-8-10-12-14-16-18-20-22-24-26-28-30)	10	100	12084	91,06
9-36	10 (9-12-15-18-21-24-27-30-33-36)	12	82	67299	163,82
12-20	9 (12-13-14-15-16-17-18-19-20)	9	75	60835	67,58
20-30	11 (20-21-22-23-24-25-26-27-28-29-30)	12	88	60837	98,50
30-40	11 (30-31-32-33-34-35-36-37-38-39-40)	13	98	60838	154,03
40-50	11 (40-41-42-43-44-45-46-47-48-49-50)	13	112	60839	229,19
50-60	11 (50-51-52-53-54-55-56-57-58-59-60)	13	120	60840	342,92



Set 3 Pcs

Cont.	Nº Art.	€
4-12, 4-20, 6-30 mm	43519	201,74

Línea 33 cm
1607

BROCA ESCALONADA HSSE INOX

Stainless HSSE Step Drill Bit
Foret étagé HSSE Inox



∅	4-12	4-20	6-30	9-36	12-20
Pcs	1	1	1	1	1

Ref. 4995 - Nº Art. 70961: **433,16 €**



Ref. **1617**

BROCA ESCALONADA **ESPIRAL HSSE INOX**

Stainless HSSE Spiral Step Drill Bit

Foret étagé spirale HSSE Inox



- Canal optimizado para virutas largas y complejas
- Avellanado especial 45°
- Filos de corte protegidos y muy afilados
- Sin rebabas
- Mayor vida útil en materiales muy duros
- Autocentrado en chapas finas
- Optimized channel for long and complex chips
- Special 45° Countersinking
- Very sharpened & protected cutting edges
- No burrs
- Longer tool life in very hard materials
- Autocentering in fine sheets
- Goujure optimisée pour copeaux longs et complexes
- Ébavurage special à 45°
- Filets des arêtes de coupe protégés et plus affûtés
- Sans bavures
- Vie utile plus longue pour aciers plus durs
- Autocentrage sur toles minces

HSSE
5% Co



Chapa
Sheets
Tôle

Materiales ferrosos
Ferrous Materials
Matériaux ferreux

Aceros
<850 N/mm²
Steel / Aciers

INOX
Stainless Steel
Acier INOX

Cobre
Copper
Cuivre

Aluminio
Aluminium

Plásticos
Plastics
Plastiques



Cap. mm	Nº Pasos* Steps* / Étages*	d mm	L mm	Nº Art.	€
4-12	9 (4-5-6-7-8-9-10-11-12)	6	80	67314	50,73
4-20	9 (4-6-8-10-12-14-16-18-20)	9	69	67316	71,98
6-30	13 (6-8-10-12-14-16-18-20-22-24-26-28-30)	10	99	67318	104,64



Set 3 Pcs

Cont.	Nº Art.	€
4-12, 4-20, 6-30 mm	67317	227,36

Línea 33 cm
1617

BROCA ESCALONADA **ESPIRAL HSSE INOX**

Stainless HSSE Spiral Step Drill Bit

Foret étagé spirale HSSE Inox



ø	4-12	4-20	6-30
Pcs	1	1	1

Ref. 4995 - Nº Art. 70964: 227,36 €

Ref. **1603**

BROCA TUBO/CHAPA

Tube-Sheet Drill Bit
Foret ampli-trou



- Nueva geometría
- Menor desgaste, mayor vida útil de la herramienta
- Mayor velocidad de corte
- Materia prima de última generación
- New geometry
- Lower wear and longer tool life
- Higher cutting speed
- Last generation raw material
- Nouvelle Géométrie
- Réduction de l'usure, vie plus longue de l'outil
- Augmentation de la vitesse de coupe
- Matière première dernière génération



Chapa
Sheets
Tôle

Metal no ferroso
Non-Ferrous Metal
Métal non ferreux

Aceros
<850 N/mm²
Steel / Aciers

Plásticos
Plastics
Plastiques



Cap. mm	d mm	L mm	Nº Art. HSS	€	Cap. mm	d mm	L mm	Nº Art. HSS	€
3-14	6	60	12090	16,01	26-40	12	85	69922	90,91
4-25,4	10	90	69921	42,98	36-50	12	97	12100	132,62
5-20	8	66	69920	26,60	40-61*	13	103	12102	221,28
8-20	8	62	69924	23,00	46-60	13	96	69923	221,28
16-30,5	10	72	12096	43,93					

* Cap. hasta fin de existencias / while stock lasts / jusqu'à la fin de stock

Línea 33 cm
1603

BROCA TUBO/CHAPA

Tube-Sheet Drill Bit
Foret ampli-trou



∅	3-14	4-25,4	5-20	16-30,5	36-50
Pcs	1	1	1	1	1

Ref. 4995 - Nº Art. 72084: 262,13 €



Ref. **1609**

BROCA TUBO/CHAPA

Tube-Sheet Drill Bit
Foret ampli-trou



- Nueva geometría
- Menor desgaste, mayor vida útil de la herramienta
- Mayor velocidad de corte
- Materia prima de última generación

- New geometry
- Lower wear and longer tool life
- Higher cutting speed
- Last generation raw material

- Nouvelle Géométrie
- Réduction de l'usure, vie plus longue de l'outil
- Augmentation de la vitesse de coupe
- Matière Première dernière génération

HSSE
5% Co



Chapa
Sheets
Tôle

Metal no ferroso
Non-Ferrous Metal
Métal non ferreux

Aceros
<850 N/mm²
Steel / Aciers

INOX
Stainless Steel
Acier INOX

Plásticos
Plastics
Plastiques



Cap. mm	d mm	L mm	Nº Art.	€
3-14	6	60	12108	31,11
4-30,5	10	102	69926	104,62
8-20	8	62	69925	41,20
16-30,5	10	72	12111	68,00

Línea 33 cm
1609

BROCA TUBO/CHAPA

Tube-Sheet Drill Bit
Foret ampli-trou



∅	3-14	4-30,5	8-20	16-30,5
Pcs	1	1	1	1

Ref. 4995 - Nº Art. 72087: 244,92 €

Ref. **1611**

BROCA MANGO E6.3 EXTRA CORTA

E6.3 Shank Stub drill Bit
Foret queue E6.3 extra-courte



D mm	L mm	l mm	d mm		Nº Art.	€
2,00	47	16	6,35	1	56512	3,49
3,00	47	16	6,35	1	15864	3,49
3,20	47	16	6,35	1	56515	3,49
3,25	47	16	6,35	1	15865	3,49
3,50	47	16	6,35	1	15892	3,24
4,00	53	20	6,35	1	15894	3,24
4,20	53	20	6,35	1	56516	3,24
4,25	53	20	6,35	1	15898	3,24
4,50	53	20	6,35	1	15899	3,07
5,00	59	26	6,35	1	15900	3,07
5,50	59	26	6,35	1	15902	3,06
6,00	59	26	6,35	1	15903	3,06
6,50	59	26	6,35	1	15904	3,06
7,00	59	26	6,35	1	15905	3,76
8,00	59	32	6,35	1	15906	3,76

Línea 33 cm
1611

BROCA MANGO E6.3 EXTRA CORTA

E6.3 Shank Stub drill Bit
Foret queue E6.3 extra-courte



ø	3	4	5	6	8
Pcs	5	5	5	5	5

Ref. 4995 - Nº Art. 72198: **83,19 €**

Ref. **1461**

SET BROCAS MANGO HEXAGONAL 1/4" Y PUNTAS DE ATORNILLAR

Hexagonal Shank Drill Bit and Screwdriver Bit Set
Jeu de forets hexagonales et embouts vissage



6 Sets

Nº Art. **€**
19322 **121,70**



Set 17 Pcs

Nº Art.	€
82204	21,35

Brocas Metal
Metal Drill Bits
Forets Métal
3- 4 - 5 - 6 mm

PH d mm: 6,35
PH1
PH2
PH3
±25 mm

PZ d mm: 6,35
PZ1
PZ2
PZ3
±25 mm

d mm: 6,35
Tx
T10
T15
T20
T25
T30
T40
±25 mm

Adapt. Quick-Lock
INOX/Stainless
L mm: 60 - d mm: 6,35

Display 54



BROCAS METAL + PARED + MADERA

Metal + Masonry + Wood Drill Bits
Forets Métal + Maçonnerie + Bois

		Ref. 1611							
∅		2	3	3,25	3,5	4	5	6	8
Pcs		3	3	3	3	3	3	3	3

		Ref. 1610						Ref. 1601	
∅		M3	M4	M5	M6	M8	M10	4	5
Pcs		2	2	2	2	2	2	3	3

		Ref. 1601			Ref. 1621				
∅		6	8	10	3	4	5	6	8
Pcs		3	3	3	3	3	3	3	3

Ref. 4995 - N° Art. 69804: 430,06 €

Ref. 1604

BROCA CORTA PUNTOS SOLDADURA

Welding Point Jobber Drill Bit
Foret courte points soudure



Ref. 1604 zirkonio
bajo demanda
upon request
sur demande

HSS
5% Co



Serie Corta
Jobber Series
Série courte

D mm	L mm	I mm	N° Art.	€
6,00	66	28	16326	10,85
8,00	80	37	16327	13,83
10,00	89	43	66909	17,32

Ref. 1605

BROCA CORTA PUNTOS SOLDADURA

Welding Point Jobber Drill Bit
Foret courte points soudure



Ref. 1605 zirkonio
bajo demanda
upon request
sur demande

HSS
8% Co



S. Extra-Corta
Stub Series
Série extra-courte

D mm	L mm	I mm	N° Art.	€
8,00	38	15	16328	17,26
8,00	45	15	16329	19,24
10,00	45	15	70687	22,90

Ref. 1606

BROCA FRESA

Milling Drill
Foret à découper la tôle



HSS



D mm	L mm	N° Art.	€
6,00	90	16330	13,70
8,00	95	16331	17,51

Ref. **1610**

BROCA-MACHO-AVELLANADOR

Combi Tap With Countersink
Outil multi-fonction



**NEW
PACKAGING!**

HSS

DIN
3126



**Aceros
<850 N/mm²
Steel / Aciers**

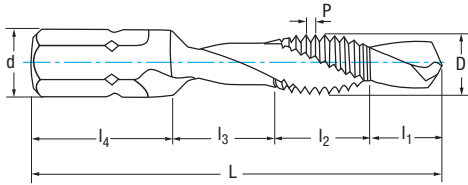

D mm	L mm	l1 mm	l2 mm	l3 mm	l4 mm	d mm	P	Avellanado Countersinking Fraisage mm		Nº Art.	€
M3	36	5	8	7	12	6,35	0,50	7,00	1	12567	17,15
M4	39	5	11	8	12	6,35	0,70	7,00	1	12571	17,15
M5	41	7	11	9	12	6,35	0,80	7,00	1	12577	19,23
M6	44	8	11	10	12	6,35	1,00	7,00	1	10971	19,84
M8	50	11	15	10	12	6,35	1,25	9,00	1	12582	27,42
M10	59	12	21	10	12	6,35	1,50	11,00	1	12583	33,08



Set 7 Pcs

Cont. Ø	Nº Art.	€
M3-M4-M5-M6-M8- M10-Adapt.	11025	133,87

Línea 33 cm
1610

BROCA-MACHO-AVELLANADOR

Combi Tap With Countersink
Outil multi-fonction



ø	M3	M4	M5	M6	M8
Pcs	2	2	2	2	2

Ref. 4995 - Nº Art. 72199: **201,58 €**

FRESAS HUECAS

Hole-Cutters

Fraises à carotter

Ref. **4078**

FRESA HUECA MÁQUINAS ELECTROMAGNÉTICAS TCT CORTA

Short TCT Core Drill

Fraise à carotter pour unité de perçage électromagnétique TCT courte

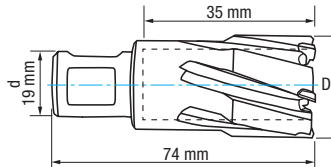

MD/HM
TCT

Serie Corta
Jobber Series
Série courte

Apto con Poca Lubricación
Suitable with Minimal Cooling
Apte avec lubrification minimale

DOBLE
WELDON

Aceros
<850 N/mm²
Steel / Aciers

INOX
Stainless Steel
Acier INOX

Fundición
Cast Iron
Fonte

Cobre
Copper
Cuivre

Latón
Brass
Laiton

Madera
Wood
Bois

D mm	d mm	L mm	l mm	Nº Art.	€	D mm	d mm	L mm	l mm	Nº Art.	€	D mm	d mm	L mm	l mm	Nº Art.	€
14	19	74	35	61963	42,26	30	19	74	35	61980	50,06	46	19	74	35	61996	113,94
15	19	74	35	61964	42,26	31	19	74	35	61981	62,23	47	19	74	35	61997	113,94
16	19	74	35	61965	42,26	32	19	74	35	61982	63,87	48	19	74	35	61998	113,94
17	19	74	35	61966	42,26	33	19	74	35	61983	64,27	49	19	74	35	61999	114,14
18	19	74	35	61967	42,26	34	19	74	35	61984	72,40	50	19	74	35	62000	118,31
19	19	74	35	61968	42,26	35	19	74	35	61985	79,43	51	19	74	35	62001	123,94
20	19	74	35	61969	42,26	36	19	74	35	61986	79,43	52	19	74	35	62002	123,94
21	19	74	35	61970	42,33	37	19	74	35	61987	79,43	53	19	74	35	62003	123,94
22	19	74	35	61971	42,33	38	19	74	35	61988	79,43	54	19	74	35	62004	123,94
23	19	74	35	61973	42,60	39	19	74	35	61989	79,43	55	19	74	35	62005	124,45
24	19	74	35	61974	43,05	40	19	74	35	61990	79,43	56	19	74	35	62006	135,12
25	19	74	35	61975	43,22	41	19	74	35	61991	92,10	57	19	74	35	62007	135,12
26	19	74	35	61976	50,06	42	19	74	35	61992	96,95	58	19	74	35	62008	135,12
27	19	74	35	61977	50,06	43	19	74	35	61993	98,85	59	19	74	35	62009	143,22
28	19	74	35	61978	50,06	44	19	74	35	61994	98,88	60	19	74	35	62010	150,42
29	19	74	35	61979	50,06	45	19	74	35	61995	98,88						

Línea 33 cm
4078

FRESA HUECA MÁQUINAS ELECTROMAGNÉTICAS TCT CORTA

Short TCT Core Drill

Fraise à carotter pour unité de perçage électromagnétique TCT courte



ø	14	16	18	20	22
Pcs	2	2	2	2	2

Ref. 4995 - Nº Art. 70967: 422,79 €

Ref. **4075**

EXPULSORES

Pilot Pins

Ejecteurs

HSS

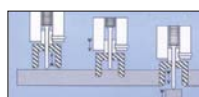

D mm	L mm	Cap. mm	Para/For/Pour Ref.	Nº Art.	€
6,34	90	12-17	4078 (35 mm)	65905	17,39
* 6,34	116	12-17	4078 (35 mm)	71750	23,73
7,98	90	18-60	4078 (35 mm)	65907	22,60
* 7,98	118	18-60	4078 (35 mm)	71880	28,48

* Para uso con adaptador
When using with adapter / Pour usage avec adaptateur

Ref. **4077**

FRESA HUECA MÁQUINAS ELECTROMAGNÉTICAS TCT LARGA

Long TCT Core Drill

Fraise à carotter pour unité de perçage électromagnétique TCT longue

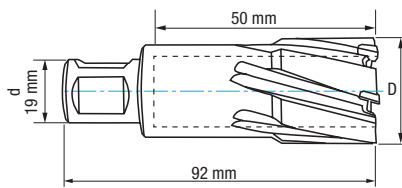

MD/HM
TCT

Serie Larga
Long Length
Série longue

Apto con Poca Lubricación
Suitable with Minimal Cooling
Apte avec lubrification minimale

DOBLE
WELDON

Aceros
<850 N/mm²
Steel / Aciers

INOX
Stainless Steel
Acier INOX

Fundición
Cast Iron
Fonte

Cobre
Copper
Cuivre

Latón
Brass
Laiton

Madera
Wood
Bois

D	d	L	l	Nº	€	D	d	L	l	Nº	€	D	d	L	l	Nº	€
mm	mm	mm	mm	Art.		mm	mm	mm	mm	Art.		mm	mm	mm	mm	Art.	
14	19	92	50	56746	60,24	30	19	92	50	56764	75,89	46	19	92	50	56780	147,03
15	19	92	50	56747	60,24	31	19	92	50	56765	91,37	47	19	92	50	56781	147,12
16	19	92	50	56749	60,24	32	19	92	50	56766	91,37	48	19	92	50	56782	147,12
17	19	92	50	56750	60,24	33	19	92	50	56767	91,37	49	19	92	50	56783	147,12
18	19	92	50	56752	60,24	34	19	92	50	56768	91,37	50	19	92	50	56784	147,12
19	19	92	50	56753	60,24	35	19	92	50	56769	91,37	51	19	92	50	56785	166,26
20	19	92	50	56754	60,24	36	19	92	50	56770	104,31	52	19	92	50	56786	166,89
21	19	92	50	56755	63,19	37	19	92	50	56771	104,70	53	19	92	50	56787	166,89
22	19	92	50	56756	63,19	38	19	92	50	56772	104,70	54	19	92	50	56788	166,89
23	19	92	50	56757	63,19	39	19	92	50	56773	104,70	55	19	92	50	56789	166,89
24	19	92	50	56758	63,27	40	19	92	50	56774	104,70	56	19	92	50	56790	183,06
25	19	92	50	56759	63,27	41	19	92	50	56775	126,30	57	19	92	50	56791	183,06
26	19	92	50	56760	75,76	42	19	92	50	56776	126,30	58	19	92	50	56792	183,06
27	19	92	50	56761	75,76	43	19	92	50	56777	126,30	59	19	92	50	56793	194,04
28	19	92	50	56762	75,89	44	19	92	50	56778	126,30	60	19	92	50	56794	199,56
29	19	92	50	56763	75,89	45	19	92	50	56779	126,30						

Línea 33 cm
4077

FRESA HUECA MÁQUINAS ELECTROMAGNÉTICAS TCT LARGA

Long TCT Core Drill

Fraise à carotter pour unité de perçage électromagnétique TCT longue



ø	14	16	18	20	22
Pcs	2	2	2	2	2

Ref. 4995 - Nº Art. 70970: 608,32 €

Ref. **4075**

EXPULSORES

Pilot Pins

Ejecteurs



HSS

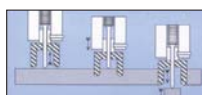

D	L	Cap.	Para/For/Pour	Nº	€
mm	mm	mm	Ref.	Art.	
6,34	106	12-17	4077 (50 mm)	61501	22,05
* 6,34	127	12-17	4077 (50 mm)	71878	18,18
7,98	105	18-60	4077 (50 mm)	61503	26,46
* 7,98	130	18-60	4077 (50 mm)	71883	33,18

* Para uso con adaptador
When using with adapter / Pour usage avec adaptateur

Ref. **4070**

FRESA HUECA MÁQUINAS ELECTROMAGNÉTICAS HSS CORTA

Short HSS Core Drill

Fraise à carotter pour unité de perçage électromagnétique HSS courte

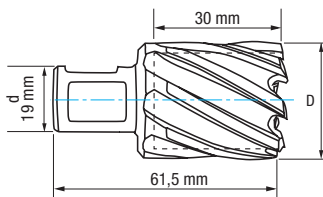

HSS	Serie Corta Jobber Series Série courte	Aceros Construcción Structural Steels Aciers de construction	Apto con Poca Lubricación Suitable with Minimal Cooling Apte avec lubrification minimale	DOBLE WELDON
Aceros <850 N/mm ² Steel / Aciers	Aceros <1000 N/mm ² Steel / Aciers	Fundición Cast Iron Fonte		



D mm	d mm	L mm	l mm	Nº Art.	€	D mm	d mm	L mm	l mm	Nº Art.	€
12	19	61,5	30	21106	25,86	37	19	61,5	30	21131	76,86
13	19	61,5	30	21107	25,86	38	19	61,5	30	21132	77,62
14	19	61,5	30	21108	26,81	39	19	61,5	30	21133	78,34
15	19	61,5	30	21109	27,93	40	19	61,5	30	21134	78,64
16	19	61,5	30	21110	29,05	41	19	61,5	30	21135	80,50
17	19	61,5	30	21111	29,98	42	19	61,5	30	21136	85,83
18	19	61,5	30	21112	31,10	43	19	61,5	30	21137	89,74
19	19	61,5	30	21113	31,86	44	19	61,5	30	21138	92,60
20	19	61,5	30	21114	33,35	45	19	61,5	30	21139	93,67
21	19	61,5	30	21115	35,61	46	19	61,5	30	21140	95,77
22	19	61,5	30	21116	36,92	47	19	61,5	30	21141	97,56
23	19	61,5	30	21117	38,43	48	19	61,5	30	21142	101,50
24	19	61,5	30	21118	39,93	49	19	61,5	30	21143	102,21
25	19	61,5	30	21119	41,23	50	19	61,5	30	21144	108,25
26	19	61,5	30	21120	42,73	51	19	61,5	30	21145	110,39
27	19	61,5	30	21121	43,10	52	19	61,5	30	21146	113,95
28	19	61,5	30	21122	45,74	53	19	61,5	30	21147	116,57
29	19	61,5	30	21123	47,24	54	19	61,5	30	21148	122,43
30	19	61,5	30	21124	48,54	55	19	61,5	30	21149	124,16
31	19	61,5	30	21125	52,85	56	19	61,5	30	21150	128,28
32	19	61,5	30	21126	56,60	57	19	61,5	30	21151	132,43
33	19	61,5	30	21127	59,60	58	19	61,5	30	21152	134,50
34	19	61,5	30	21128	68,00	59	19	61,5	30	21153	142,08
35	19	61,5	30	21129	75,26	60	19	61,5	30	21154	150,41
36	19	61,5	30	21130	75,50						



Set 6 Pcs

Cont. Ø	Nº Art.	€
12-14-16-18-20-22	66858	183,08



Set 5 Pcs

Cont. Ø	Nº Art.	€
24-26-28-30-32	66859	233,52

Línea 33 cm
4070

FRESA HUECA MÁQUINAS ELECTROMAGNÉTICAS HSS CORTA

Short HSS Core Drill

Fraise à carotter pour unité de perçage électromagnétique HSS courte



Ø	14	16	18	20	22
Pcs	2	2	2	2	2

Ref. 4995 - Nº Art. 70974: 314,44 €

Ref. **4075**

EXPULSORES

Pilot Pins

Ejecteurs

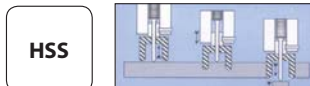

HSS

D mm	L mm	Para/For/Pour Ref.	Nº Art.	€
6,34	77	4070 (30 mm)	61502	9,39
* 6,34	102	4070 (30 mm)	61500	12,96

* Para uso con adaptador
When using with adapter
Pour usage avec adaptateur

Ref. **4071**

FRESA HUECA MÁQUINAS ELECTROMAGNÉTICAS HSS LARGA

Long HSS Core Drill

Fraise à carotter pour unité de perçage électromagnétique HSS longue

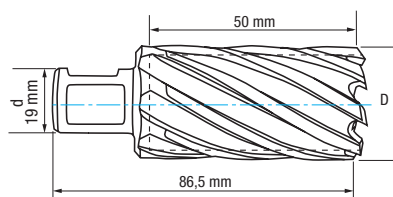

HSS	Serie Larga Long Length Série longue	Aceros Construcción Structural Steels Aciers de construction	Apto con Poca Lubricación Suitable with Minimal Cooling Apte avec lubrification minimale	Rectificado Ground Taillé meulé	DOBLE WELDON
Aceros <850 N/mm² Steel / Aciers	Aceros <1000 N/mm² Steel / Aciers	Fundición Cast Iron Fonte	Aluminio Aluminium		

D mm	d mm	L mm	l mm	Nº Art.	€
12	19	86,5	50	73338	35,82
13	19	86,5	50	73339	35,82
14	19	86,5	50	21157	37,13
15	19	86,5	50	21158	38,62
16	19	86,5	50	21159	41,23
17	19	86,5	50	21160	42,73
18	19	86,5	50	21161	45,93
19	19	86,5	50	21162	46,85
20	19	86,5	50	21163	48,18
21	19	86,5	50	21164	53,60
22	19	86,5	50	21165	55,11
23	19	86,5	50	21166	56,98
24	19	86,5	50	21167	58,67
25	19	86,5	50	21168	60,35
26	19	86,5	50	21169	62,23
27	19	86,5	50	21170	65,22

D mm	d mm	L mm	l mm	Nº Art.	€
28	19	86,5	50	21171	68,22
29	19	86,5	50	21172	70,83
30	19	86,5	50	21173	71,65
31	19	86,5	50	21174	75,26
32	19	86,5	50	21175	78,55
33	19	86,5	50	21177	82,19
34	19	86,5	50	21178	85,82
35	19	86,5	50	21179	89,45
36	19	86,5	50	21180	92,00
37	19	86,5	50	21181	95,45
38	19	86,5	50	21182	98,18
39	19	86,5	50	21183	101,09
40	19	86,5	50	21184	106,33
41	19	86,5	50	21185	108,07
42	19	86,5	50	21186	109,47
43	19	86,5	50	21187	112,26
44	19	86,5	50	21188	113,65

D mm	d mm	L mm	l mm	Nº Art.	€
45	19	86,5	50	21189	117,13
46	19	86,5	50	21190	118,53
47	19	86,5	50	21191	125,15
48	19	86,5	50	21192	128,28
49	19	86,5	50	21193	128,98
50	19	86,5	50	21194	131,77
51	19	86,5	50	21195	139,44
52	19	86,5	50	21196	145,02
53	19	86,5	50	21197	162,43
54	19	86,5	50	21198	164,84
55	19	86,5	50	21199	166,42
56	19	86,5	50	21200	171,40
57	19	86,5	50	21201	182,11
58	19	86,5	50	21202	182,15
59	19	86,5	50	21203	192,50
60	19	86,5	50	21204	199,53

Línea 33 cm
4071

FRESA HUECA MÁQUINAS ELECTROMAGNÉTICAS HSS LARGA

Long HSS Core Drill

Fraise à carotter pour unité de perçage électromagnétique HSS longue



ø	14	16	18	20	22
Pcs	2	2	2	2	2

Ref. 4995 - Nº Art. 70978: 455,15 €

Ref. **4075**

EXPULSORES

Pilot Pins

Ejecteurs



HSS

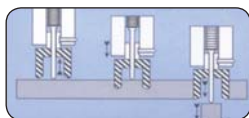

D mm	L mm	Para/For/Pour Ref.	Nº Art.	€
6,34	102	4071 (50 mm)	61500	12,96
* 6,34	127	4071 (50 mm)	71878	18,18

* Para uso con adaptador

When using with adapter / Pour usage avec adaptateur

Ref. **4072**

FRESA HUECA MÁQUINAS ELECTROMAGNÉTICAS HSS EXTRA LARGA

Extra Long HSS Core Drill

Fraise à carotter pour unité de perçage électromagnétique HSS extra-longue

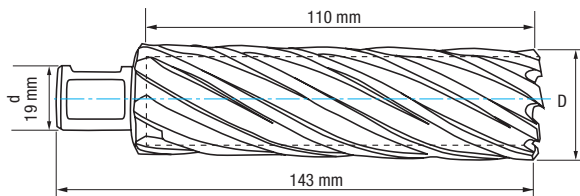

HSS

Serie Extra-Larga
Extra-Long Series
Série extra-longue

Aceros Construcción
Structural Steels
Aciers de construction

Apto con Poca Lubricación
Suitable with Minimal Cooling
Apte avec lubrification minimale

DOBLE
WELDON



Aceros
<850 N/mm²
Steel / Aciers

Aceros
<1000 N/mm²
Steel / Aciers

Fundición
Cast Iron
Fonte

Aluminio
Aluminium

D mm	d mm	L mm	l mm	Nº Art.	€
20	19	143	110	56694	96,17
21	19	143	110	56695	97,99
22	19	143	110	56696	99,84
23	19	143	110	56697	101,82
24	19	143	110	56698	107,88
25	19	143	110	56699	109,86
26	19	143	110	56700	121,30
27	19	143	110	56701	123,50
28	19	143	110	56702	125,93
29	19	143	110	56703	128,29
30	19	143	110	56704	130,74

D mm	d mm	L mm	l mm	Nº Art.	€
31	19	143	110	56706	136,40
32	19	143	110	56707	138,81
33	19	143	110	56708	148,63
34	19	143	110	56709	151,32
35	19	143	110	56710	154,09
36	19	143	110	56711	156,94
37	19	143	110	56712	160,20
38	19	143	110	56714	163,21
39	19	143	110	56715	166,29
40	19	143	110	56716	169,46
41	19	143	110	56717	198,37

D mm	d mm	L mm	l mm	Nº Art.	€
42	19	143	110	56718	201,69
43	19	143	110	56719	205,09
44	19	143	110	56721	208,57
45	19	143	110	56722	251,41
46	19	143	110	56724	254,82
47	19	143	110	56725	258,40
48	19	143	110	56727	261,86
49	19	143	110	56728	265,42
50	19	143	110	56730	269,04

Línea 33 cm
4072

FRESA HUECA MÁQUINAS ELECTROMAGNÉTICAS HSS EXTRA LARGA

Extra Long HSS Core Drill

Fraise à carotter pour unité de perçage électromagnétique HSS extra-longue



∅	20	22	26	32	40
Pcs	1	1	1	1	1

Ref. 4995 - Nº Art. 72090: 625,58 €

Ref. **4075**

EXPULSORES

Pilot Pins

Ejecteurs



HSS

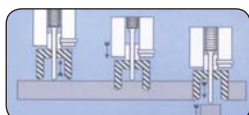

D mm	L mm	Para/For/Pour Ref.	Nº Art.	€
7,98	154	4072 (110 mm)	61504	22,95
* 7,98	180	4072 (110 mm)	71885	34,73

* Para uso con adaptador
When using with adapter
Pour usage avec adaptateur

Ref. **4079**

BROCA MÁQUINAS ELECTROMAGNÉTICAS HSS

HSS Solid Drill

Foret pour unité de perçage électromagnétique HSS

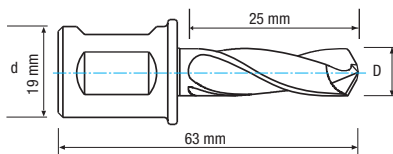

HSS

Serie Corta
Jobber Series
Série courte

Aceros Construcción
Structural Steels
Aciers de construction

Apto con Poca Lubricación
Suitable with Minimal Cooling
Apte avec lubrification minimale

DOBLE
WELDON

Aceros
<850 N/mm²
Steel / Aciers

Aceros
<1000 N/mm²
Steel / Aciers

Fundición
Cast Iron
Fonte



D mm	d mm	L mm	l mm	Nº Art.	€
6	19	63	25	69758	24,89
8	19	63	25	69761	24,89
10	19	63	25	69763	25,86
12	19	63	25	69768	28,74
14	19	63	25	69769	29,79

Línea 33 cm
4079

BROCA MÁQUINAS ELECTROMAGNÉTICAS HSS

HSS Solid Drill

Foret pour unité de perçage électromagnétique HSS



ø	6	8	10	12	14
Pcs	1	1	1	1	1

Ref. 4995 - Nº Art. 70982: 134,16 €



Ref. **4076**

AVELLANADOR MÁQUINA ELECTROMAGNÉTICA

Core Drill Countersink

Fraise à noyer pour unité de perçage électromagnétique



Aceros <850 N/mm ² Steel / Aciers	INOX Stainless Steel Acier INOX	Fundición Cast Iron Fonte	Cobre Copper Cuivre	Latón Brass Laiton	Madera Wood Bois
---	--	--	----------------------------------	---------------------------------	-------------------------------

D+ mm	D- mm	d mm	L mm	Nº Art.	€
25	3	19	45	61505	119,89
30	3	19	47	61506	120,52
40	3	19	52	61507	139,70
50	3	19	57	61508	159,03
55	3	19	60	61509	177,87

Línea 33 cm
4076

AVELLANADOR MÁQUINA ELECTROMAGNÉTICA

Core Drill Countersink

Fraise à noyer pour unité de perçage électromagnétique



∅	25	30	40	50	55
Pcs	1	1	1	1	1

Ref. 4995 - Nº Art. 72093: 716,99 €

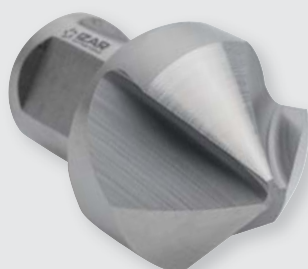

Ref. **4074**

ADAPTADOR FRESA HUECA MÁQUINA ELECTROMAGNÉTICA

Core Drill Adaptor

Adaptateur pour fraise à carotter pour unité de perçage électromagnétique



Fresa Cutter Fraise	Máquina Machine	Expulsor mm Pilot Pin Ejecteur	L mm	I mm	Nº Art.	€
Doble Weldon	Fein Quick In	6,35	51,20	28,60	61510	29,35
Doble Weldon	Fein Quick In	7,98	51,20	28,60	61511	29,35



Fresa Cutter Fraise	Máquina Machine	Expulsor mm Pilot Pin Ejecteur	L mm	I mm	Nº Art.	€
Doble Weldon	Universal	6,35	51,20	28,60	61512	28,78
Doble Weldon	Universal	7,98	51,20	28,60	61513	28,78



Entrada In Entrée	Salida Out Sortie	L mm	Nº Art.	€
Doble Weldon	1/2x20h	43	83450	29,93



Entrada In Entrée	Salida Out Sortie	L mm	Nº Art.	€
Doble Weldon	B16	57	83449	29,93













ELECCIÓN ADAPTADORES FRESAS HUECAS DOBLE WELDON

Double Weldon Core Drill Adaptor Choice



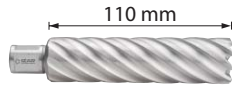



Choix d'adaptateurs pour fraises à carotter Double Weldon

Ref. 4075		Ref. 4074		Ref. 4075	
Fresa Cutter Fraise	Expulsor sin Adaptador Pilot Pin without adapter Ejecteur sans adaptateur	Adaptador Máquina Adaptor Machine Adaptateur machine	* Expulsor para uso con adaptador * Pilot Pin when using with Adapter * Ejecteur pour usage avec adaptateur		
DOBLE WELDON		FEIN QUICK IN			
	(12-17 mm) 6,34 x 90 mm. Art. 65905		(12-17 mm) * 6,34 x 116 mm. Art. 71750		
	(12-17 mm) 6,34 x 106 mm. Art. 61501		(12-17 mm) * 6,34 x 127 mm. Art. 71878		
	6,34 x 77 mm. Art. 61502		* 6,34 x 102 mm. Art. 61500		
	6,34 x 102 mm. Art. 61500		* 6,34 x 127 mm. Art. 71878		
	(18-60 mm) 7,98 x 90 mm. Art. 65907		(18-60 mm) * 7,98 x 118 mm. Art. 71880		
	(18-60 mm) 7,98 x 105 mm. Art. 61503		(18-60 mm) * 7,98 x 130 mm. Art. 71883		
	7,98 x 154 mm. Art. 61504	* 7,98 x 180 mm. Art. 71885			

ELECCIÓN ADAPTADORES FRESAS HUECAS DOBLE WELDON

Double Weldon Core Drill Adaptor Choice

Choix d'adaptateurs pour fraises à carotter Double Weldon

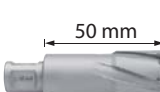
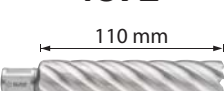
Ref. 4075		Ref. 4074		Ref. 4075	
Fresa Cutter Fraise	Expulsor sin Adaptador Pilot Pin without adapter Ejecteur sans adaptateur	Adaptador Máquina Adaptor Machine Adaptateur machine	UNIVERSAL Nitto + Weldon	* Expulsor para uso con adaptador * Pilot Pin when using with Adapter * Ejecteur pour usage avec adaptateur	
4078 	(12-17 mm) 6,34 x 90 mm. Art. 65905	 Art. 61512		(12-17 mm) * 6,34 x 116 mm. Art. 71750	
4077 	(12-17 mm) 6,34 x 106 mm. Art. 61501			(12-17 mm) * 6,34 x 127 mm. Art. 71878	
4070 	6,34 x 77 mm. Art. 61502			* 6,34 x 102 mm. Art. 61500	
4071 	6,34 x 102 mm. Art. 61500			* 6,34 x 127 mm. Art. 71878	
4078 	(18-60 mm) 7,98 x 90 mm. Art. 65907	 Art. 61513		(18-60 mm) * 7,98 x 118 mm. Art. 71880	
4077 	(18-60 mm) 7,98 x 105 mm. Art. 61503			(18-60 mm) * 7,98 x 130 mm. Art. 71883	
4072 	7,98 x 154 mm. Art. 61504			* 7,98 x 180 mm. Art. 71885	

Ref. **4067**

FRESA HUECA MÁQUINAS ELECTROMAGNÉTICAS TCT LARGA

Long TCT Core Drill

Fraise à carotter pour unité de perçage électromagnétique TCT longue

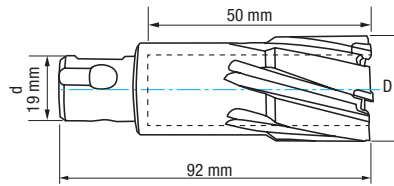

MD/HM
TCT

Serie Larga
Long Length
Série longue

Apto con Poca Lubricación
Suitable with Minimal Cooling
Apte avec lubrification minimale

UNIVERSAL:
NITTO +
WELDON

Aceros
<850 N/mm²
Steel / Aciers

INOX
Stainless Steel
Acier INOX

Fundición
Cast Iron
Fonte

Cobre
Copper
Cuivre

Latón
Brass
Laiton

Madera
Wood
Bois

D mm	d mm	L mm	l mm	Nº Art.	€	D mm	d mm	L mm	l mm	Nº Art.	€	D mm	d mm	L mm	l mm	Nº Art.	€
14	19	92	50	61248	60,24	30	19	92	50	61264	75,89	46	19	92	50	61280	147,03
15	19	92	50	61249	60,24	31	19	92	50	61265	91,37	47	19	92	50	61281	147,12
16	19	92	50	61250	60,24	32	19	92	50	61266	91,37	48	19	92	50	61282	147,12
17	19	92	50	61251	60,24	33	19	92	50	61267	91,37	49	19	92	50	61283	147,12
18	19	92	50	61252	60,24	34	19	92	50	61268	91,37	50	19	92	50	61199	147,12
19	19	92	50	61253	60,24	35	19	92	50	61269	91,37	51	19	92	50	61284	166,26
20	19	92	50	61254	60,24	36	19	92	50	61270	104,31	52	19	92	50	61285	166,89
21	19	92	50	61255	63,19	37	19	92	50	61271	104,70	53	19	92	50	61286	166,89
22	19	92	50	61256	63,19	38	19	92	50	61272	104,70	54	19	92	50	61287	166,89
23	19	92	50	61257	63,19	39	19	92	50	61273	104,70	55	19	92	50	61288	166,89
24	19	92	50	61258	63,27	40	19	92	50	61274	104,70	56	19	92	50	61289	183,06
25	19	92	50	61259	63,27	41	19	92	50	61275	126,30	57	19	92	50	61290	183,06
26	19	92	50	61260	75,76	42	19	92	50	61276	126,30	58	19	92	50	61291	183,06
27	19	92	50	61261	75,76	43	19	92	50	61277	126,30	59	19	92	50	61292	194,04
28	19	92	50	61262	75,89	44	19	92	50	61278	126,30	60	19	92	50	61293	199,56
29	19	92	50	61263	75,89	45	19	92	50	61279	126,30						

Línea 33 cm
4067

FRESA HUECA MÁQUINAS ELECTROMAGNÉTICAS TCT LARGA

Long TCT Core Drill

Fraise à carotter pour unité de perçage électromagnétique TCT longue



ø	14	16	18	20	22
Pcs	2	2	2	2	2

Ref. 4995 - Nº Art. 72096: **608,32 €**

Ref. **4075**

EXPULSORES

Pilot Pins

Ejecteurs



HSS

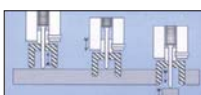

D mm	L mm	Cap. mm	Para/For/Pour Ref.	Nº Art.	€
6,34	106	12-17	4067 (50 mm)	61501	22,05
7,98	105	18-60	4067 (50 mm)	61503	26,46

Ref. **4060**

FRESA HUECA MÁQUINAS ELECTROMAGNÉTICAS HSS CORTA

Short HSS Core Drill

Fraise à carotter pour unité de perçage électromagnétique HSS courte

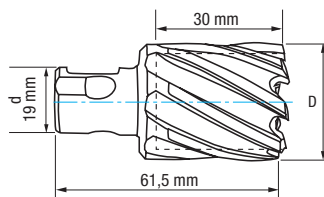

HSS

Serie Corta
Jobber Series
Série courte

Aceros Construcción
Structural Steels
Aciers de construction

Apto con Poca Lubricación
Suitable with Minimal Cooling
Apte avec lubrification minimale

UNIVERSAL:
NITTO +
WELDON

Aceros
<850 N/mm²
Steel / Aciers

Aceros
<1000 N/mm²
Steel / Aciers

Fundición
Cast Iron
Fonte

Aluminio
Aluminium



D mm	d mm	L mm	l mm	Nº Art.	€
12	19	61,5	30	61120	25,86
13	19	61,5	30	61121	25,86
14	19	61,5	30	61122	26,81
15	19	61,5	30	61123	27,93
16	19	61,5	30	61124	29,05
17	19	61,5	30	61125	29,98
18	19	61,5	30	61126	31,10
19	19	61,5	30	61127	31,86
20	19	61,5	30	61128	33,35
21	19	61,5	30	61129	35,61
22	19	61,5	30	61130	36,92
23	19	61,5	30	61131	38,43
24	19	61,5	30	61132	39,93
25	19	61,5	30	61133	41,23
26	19	61,5	30	61134	42,73
27	19	61,5	30	61135	43,10
28	19	61,5	30	61136	45,74
29	19	61,5	30	61137	47,24
30	19	61,5	30	61138	48,54
31	19	61,5	30	61139	52,85
32	19	61,5	30	61140	56,60
33	19	61,5	30	61141	59,60
34	19	61,5	30	61142	68,00
35	19	61,5	30	61143	75,26
36	19	61,5	30	61144	75,50

D mm	d mm	L mm	l mm	Nº Art.	€
37	19	61,5	30	61145	76,86
38	19	61,5	30	61146	77,62
39	19	61,5	30	61147	78,34
40	19	61,5	30	61148	78,64
41	19	61,5	30	61149	80,50
42	19	61,5	30	61150	85,83
43	19	61,5	30	61151	89,74
44	19	61,5	30	61152	92,60
45	19	61,5	30	61153	93,67
46	19	61,5	30	61154	95,77
47	19	61,5	30	61155	97,56
48	19	61,5	30	61156	101,50
49	19	61,5	30	61157	102,21
50	19	61,5	30	61158	108,25
51	19	61,5	30	61159	110,39
52	19	61,5	30	61160	113,95
53	19	61,5	30	61161	116,57
54	19	61,5	30	61162	122,43
55	19	61,5	30	61163	124,16
56	19	61,5	30	61164	128,28
57	19	61,5	30	61165	132,43
58	19	61,5	30	61166	134,50
59	19	61,5	30	61167	142,08
60	19	61,5	30	61168	150,41



Set 6 Pcs

Cont. Ø	Nº Art.	€
12-14-16-18-20-22	66860	183,08



Set 5 Pcs

Cont. Ø	Nº Art.	€
24-26-28-30-32	66861	233,52

Línea 33 cm
4060

FRESA HUECA MÁQUINAS ELECTROMAGNÉTICAS HSS CORTA

Short HSS Core Drill

Fraise à carotter pour unité de perçage électromagnétique HSS courte



Ø	14	16	18	20	22
Pcs	2	2	2	2	2

Ref. 4995 - Nº Art. 72099: 314,44 €

Ref. **4075**

EXPULSORES

Pilot Pins

Ejecteurs



HSS

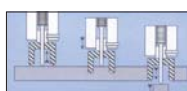

D mm	L mm	Para/For/Pour Ref.	Nº Art.	€
6,34	77	4060 (30 mm)	61502	9,39

Ref. **4061**

FRESA HUECA MÁQUINAS ELECTROMAGNÉTICAS HSS LARGA

Long HSS Core Drill

Fraise à carotter pour unité de perçage électromagnétique HSS longue

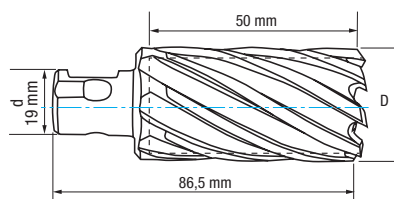

HSS	Serie Larga Long Length Série longue	Aceros Construcción Structural Steels Aciers de construction	Apto con Poca Lubricación Suitable with Minimal Cooling Apte avec lubrification minimale	Rectificado Ground Taillé meulé	UNIVERSAL: NITTO + WELDON
Aceros <850 N/mm ² Steel / Aciers	Aceros <1000 N/mm ² Steel / Aciers	Fundición Cast Iron Fonte	Aluminio Aluminium		

D mm	d mm	L mm	l mm	Nº Art.	€	D mm	d mm	L mm	l mm	Nº Art.	€	D mm	d mm	L mm	l mm	Nº Art.	€
12	19	86,5	50	73340	35,82	28	19	86,5	50	61183	68,22	45	19	86,5	50	61201	117,13
13	19	86,5	50	73342	35,82	29	19	86,5	50	61184	70,83	46	19	86,5	50	61202	118,53
14	19	86,5	50	61169	37,13	30	19	86,5	50	61185	71,65	47	19	86,5	50	61203	125,15
15	19	86,5	50	61170	38,62	31	19	86,5	50	61186	75,26	48	19	86,5	50	61204	128,28
16	19	86,5	50	61171	41,23	32	19	86,5	50	61187	78,55	49	19	86,5	50	61205	128,98
17	19	86,5	50	61172	42,73	33	19	86,5	50	61188	82,19	50	19	86,5	50	61206	131,77
18	19	86,5	50	61173	45,93	34	19	86,5	50	61189	85,82	51	19	86,5	50	61207	139,44
19	19	86,5	50	61174	46,85	35	19	86,5	50	61190	89,45	52	19	86,5	50	61208	145,02
20	19	86,5	50	61175	48,18	36	19	86,5	50	61191	92,00	53	19	86,5	50	61209	162,43
21	19	86,5	50	61176	53,60	37	19	86,5	50	61192	95,45	54	19	86,5	50	61210	164,84
22	19	86,5	50	61177	55,11	38	19	86,5	50	61193	98,18	55	19	86,5	50	61211	166,42
23	19	86,5	50	61178	56,98	39	19	86,5	50	61194	101,09	56	19	86,5	50	61212	171,40
24	19	86,5	50	61179	58,67	40	19	86,5	50	61195	106,33	57	19	86,5	50	61213	182,11
25	19	86,5	50	61180	60,35	41	19	86,5	50	61196	108,07	58	19	86,5	50	61214	182,15
26	19	86,5	50	61181	62,23	42	19	86,5	50	61197	109,47	59	19	86,5	50	61215	192,50
27	19	86,5	50	61182	65,22	43	19	86,5	50	61198	112,26	60	19	86,5	50	61216	199,53
						44	19	86,5	50	61200	113,65						

Línea 33 cm
4061

FRESA HUECA MÁQUINAS ELECTROMAGNÉTICAS HSS LARGA

Long HSS Core Drill

Fraise à carotter pour unité de perçage électromagnétique HSS longue



ø	14	16	18	20	22
Pcs	2	2	2	2	2

Ref. 4995 - Nº Art. 72105: 455,15 €

Ref. **4075**

EXPULSORES

Pilot Pins

Ejecteurs



HSS

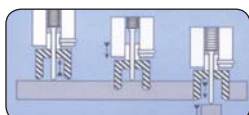

D mm	L mm	Para/For/Pour Ref.	Nº Art.	€
6,34	102	4061 (50 mm)	61500	12,96

Ref. **4062**

FRESA HUECA MÁQUINAS ELECTROMAGNÉTICAS HSS EXTRA LARGA

Extra Long HSS Core Drill

Fraise à carotter pour unité de perçage électromagnétique HSS extra-longue

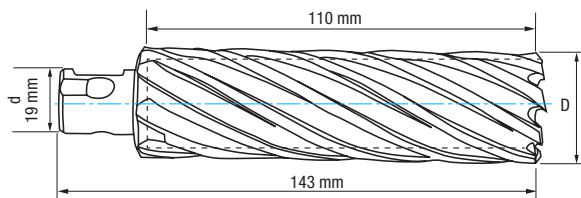

HSS

Serie Extra-Larga
Extra-Long Series
Série extra-longue

Aceros Construcción
Structural Steels
Aciers de construction

Apto con Poca Lubricación
Suitable with Minimal Cooling
Apte avec lubrification minimale

UNIVERSAL:
NITTO +
WELDON

Aceros
<850 N/mm²
Steel / Aciers

Aceros
<1000 N/mm²
Steel / Aciers

Fundición
Cast Iron
Fonte

Aluminio
Aluminium



D mm	d mm	L mm	l mm	Nº Art.	€	D mm	d mm	L mm	l mm	Nº Art.	€	D mm	d mm	L mm	l mm	Nº Art.	€
20	19	143	110	61217	96,17	31	19	143	110	61228	136,40	42	19	143	110	61239	201,69
21	19	143	110	61218	97,99	32	19	143	110	61229	138,81	43	19	143	110	61240	205,09
22	19	143	110	61219	99,84	33	19	143	110	61230	148,63	44	19	143	110	61241	208,57
23	19	143	110	61220	101,82	34	19	143	110	61231	151,32	45	19	143	110	61242	251,41
24	19	143	110	61221	107,88	35	19	143	110	61232	154,09	46	19	143	110	61243	254,82
25	19	143	110	61222	109,86	36	19	143	110	61233	156,94	47	19	143	110	61244	258,40
26	19	143	110	61223	121,30	37	19	143	110	61234	160,20	48	19	143	110	61245	261,86
27	19	143	110	61224	123,50	38	19	143	110	61235	163,21	49	19	143	110	61246	265,42
28	19	143	110	61225	125,93	39	19	143	110	61236	166,29	50	19	143	110	61247	269,04
29	19	143	110	61226	128,29	40	19	143	110	61237	169,46						
30	19	143	110	61227	130,74	41	19	143	110	61238	198,37						

Línea 33 cm
4062

FRESA HUECA MÁQUINAS ELECTROMAGNÉTICAS HSS EXTRA LARGA

Extra Long HSS Core Drill

Fraise à carotter pour unité de perçage électromagnétique HSS extra-longue



ø	20	22	26	32	40
Pcs	1	1	1	1	1

Ref. 4995 - Nº Art. 72108: 625,58 €

Ref. **4075**

EXPULSORES

Pilot Pins

Ejecteurs



HSS

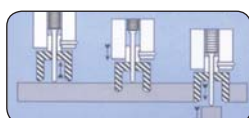

D mm	L mm	Para/For/Pour Ref.	Nº Art.	€
7,98	154	4062 (110 mm)	61504	22,95

CORONAS

Hole Saws

Trépan

Ref. **1667**

CORONA REAFILABLE HSS

HSS Resharpenable Hole Saw
Fraise réaffûtable HSS

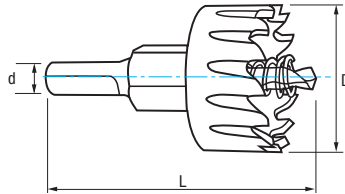

Aceros <850 N/mm ² Steel / Aciers	Fundición Cast Iron Fonte	Cobre Copper Cuivre	Latón Brass Laiton	Aluminio Aluminium	Madera Wood Bois
---	--	----------------------------------	---------------------------------	------------------------------	-------------------------------

D mm	d mm	L mm	D mm Broca Drill Bit Foret	Nº Art.	€
12	10	75,50	6	56569	17,32
13	10	75,50	6	56570	17,32
14	10	75,50	6	56572	17,32
15	10	75,50	6	56573	17,32
16	10	75,50	6	56152	17,32
17	10	75,50	6	56576	18,58
18	10	75,50	6	56578	19,93
19	10	75,50	6	56579	21,08
20	10	75,50	6	56154	22,24
21	10	75,50	6	56582	22,24
22	10	75,50	6	56155	23,39
23	10	75,50	6	56583	24,54
24	10	75,50	6	56584	25,84
25	10	75,50	6	56156	27,00
26	10	75,50	6	56585	28,15
27	10	75,50	6	56157	29,31
28	10	75,50	6	56587	30,86
29	10	75,50	6	56588	32,01
30	10	75,50	6	56158	32,01
32	10	75,50	6	56159	34,33

D mm	d mm	L mm	D mm Broca Drill Bit Foret	Nº Art.	€
33	10	75,50	6	56590	35,48
35	10	75,50	6	56160	36,64
36	10	75,50	6	56591	38,94
38	10	75,50	6	56593	40,76
39	10	75,50	6	56594	41,92
40	10	75,50	6	56161	43,08
42	10	75,50	6	56596	45,32
45	10	75,50	6	56597	48,82
48	10	75,50	6	56163	51,27
49	10	75,50	6	68602	53,20
50	10	75,50	6	56164	53,59
51	10	75,50	6	68604	65,29
53	10	75,50	6	56599	65,29
55	10	75,50	6	56600	66,59
60	10	75,50	6	56165	73,10
63	10	75,50	6	68605	88,71
65	10	75,50	6	56602	88,71
68	10	75,50	6	68607	102,39
70	10	75,50	6	56166	102,39
75	10	75,50	6	56167	110,20

D mm	d mm	L mm	D mm Broca Drill Bit Foret	Nº Art.	€
76	10	75,50	6	68608	128,36
80	10	75,50	6	56603	128,36
85	10	75,50	6	56605	135,27
90	10	75,50	6	56606	149,58
100	10	75,50	6	56608	163,88

* Broca y muelle incluidos
Drill Bit & Spring included
Foret et ressort inclus



Set 6 Pcs

Cont. Ø	Nº Art.	€
12-14-16-18-20-22	77448	117,51

TIN

Bajo demanda / upon request / sur demande

Ref. **1664**



Broca / Drill Bit / Foret

D mm	L mm	Nº Art.	€ 1 ud.
6	48	60704	3,92



Muelle / Spring / Ressort

D mm	L mm	Nº Art.	€ pack
8,5	20	60637	0,90
8,5	35	60638	0,92



Expo
1667

EXPOSITOR CORONAS REAFILABLES HSS

HSS Resharpenable Hole Saw Exhibitor
Présentoir fraises réaffûtables HSS

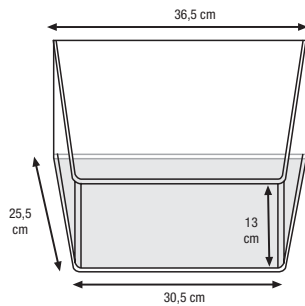

31 Pcs

N° Art.	€
66804	1.002,63

Diam.	N° Art.	Uds.	Diam.	N° Art.	Uds.
12	56569	1	28	56587	1
13	56570	1	29	56588	1
14	56572	1	30	56158	1
15	56573	1	32	56159	1
16	56152	1	33	56590	1
17	56576	1	35	56160	1
18	56578	1	36	56591	1
19	56579	1	38	56593	1
20	56154	1	39	56594	1
21	56582	1	40	56161	1
22	56155	1	42	56596	1
23	56583	1	45	56597	1
24	56584	1	48	56163	1
25	56156	1	50	56164	1
26	56585	1	65	56602	1
27	56157	1			

Línea 1m
1667

CORONA REAFILABLE HSS

HSS Resharpenable Hole Saw
Fraise réaffûtable HSS



ø	16	19	20	22	24	25	27	29	30	32	35	51	63	65
Pcs	1	1	1	1	1	1	1	1	1	1	1	1	1	1

Ref. 4995 - N° Art. 72109: 543,88 €

Display
65

CORONA REAFILABLE HSS

HSS Resharpenable Hole Saw
Fraise réaffûtables HSS



ø	16	18	20	22	24	25	27	32
Pcs	1	1	1	1	1	1	1	1

Ref. 4995 - N° Art. 70083: 199,35 €

Ref. **1663**

CORONA INOX ALTO RENDIMIENTO

TCT High Performance STAINLESS Hole Saw
Trépan INOX haut rendement

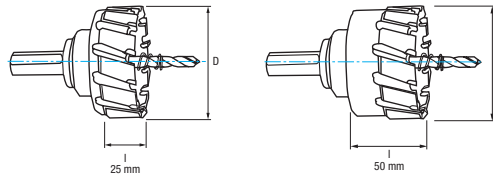

Husillo incluido
Included Spindle
Arbre compris

Cono Morse opcional
Optional Morse Taper
Cône Morse optionel

Broca incluida
Included Center Drill
Foret compris

Diente MD
Carbide Tipped
Dent carbure

PVC

Fibra Vidrio
Fiberglass
Fibre de verre

Aceros
<850 N/mm²
Steel / Aciers

Plásticos
Plastics
Plastiques

INOX
Stainless Steel
Acier INOX

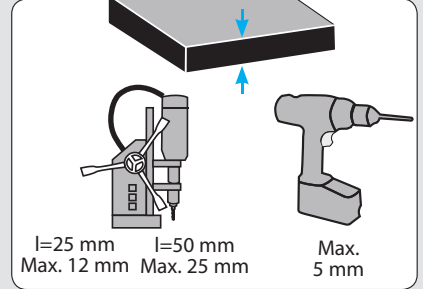
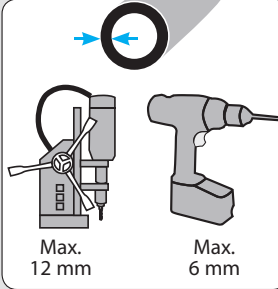

D mm	l mm	d mm	Nº Art.	€
14	25	13	71756	78,71
15	25	13	71758	78,71
16	25	13	71760	78,71
17	25	13	71761	78,71
18	25	13	71762	79,00
19	25	13	71763	78,71
20	25	13	71764	80,20
21	25	13	71765	82,79
22	25	13	71768	82,79
23	25	13	71769	83,98
24	25	13	71770	83,98
25	25	13	71771	83,98
26	25	13	71772	85,35
27	25	13	71773	86,74
28	25	13	71774	86,74
29	25	13	71775	86,74
30	25	13	71776	86,74
31	25	13	71777	97,95
32	25	13	71780	101,47
33	25	13	71781	101,47
34	25	13	71782	102,58
35	25	13	71783	102,58
36	25	13	71784	114,93
37	25	13	71785	114,93

D mm	l mm	d mm	Nº Art.	€
38	25	13	71787	117,80
39	25	13	71788	117,80
40	25	13	71789	119,03
41	25	13	71790	129,46
42	25	13	71791	141,00
43	25	13	71792	141,00
44	25	13	71793	141,00
45	25	13	71794	145,00
46	25	13	71795	147,67
47	25	13	71796	147,67
48	25	13	71797	147,67
49	25	13	71798	147,67
50	25	13	71799	150,00
51	25	13	71800	174,72
52	25	13	71801	174,72
53	25	13	71802	175,96
54	25	13	71803	175,96
55	25	13	71804	175,96
56	25	13	71805	195,43
57	25	13	71806	195,43
58	25	13	71807	195,43
59	25	13	71808	195,43
60	25	13	71809	195,43

D mm	l mm	d mm	Nº Art.	€
18	50	13	71952	90,84
20	50	13	71953	92,24
22	50	13	71955	95,21
25	50	13	71956	96,58
30	50	13	71957	99,76
35	50	13	71958	112,85
40	50	13	71959	130,92
45	50	13	71960	159,51
50	50	13	71961	165,01
55	50	13	71962	193,55
60	50	13	71963	214,98
65	50	13	71810	230,51
68	50	13	71964	248,77
70	50	13	71811	248,77
75	50	13	71812	252,07
80	50	13	71814	260,93
85	50	13	71815	270,33
90	50	13	71817	276,86
95	50	13	71818	277,36
100	50	13	71819	281,10
105	50	13	71965	296,59
110	50	13	71966	329,41
115	50	13	71967	365,12
120	50	13	71968	404,07
125	50	13	71970	432,27

Ref. **1659**

ACCESORIOS / Accessories / Accessoires



Broca Centrar *
Center Drill / Foret à centrer



Para Corona	Cap.	D	L	l	Nº	€
For Hole Saw	mm	mm	mm	mm	Art.	
Pour Trépan						
l mm						
25	14-60	6	80	30	71982	13,18
25	61-125	8	80	30	71983	14,45
50	14-60	6	110	55	71985	19,06
50	61-125	8	110	55	71986	23,29

Husillo 3 Planos *
3-Flat Spindle / Arbre 3 plans



Cap.	L	Nº	€
mm	mm	Art.	
14-60	53	71977	20,72
61-100	53	71979	20,72
101-125	57	71980	33,27

Cono Morse **
Morse Taper / Cône Morse



CM	Cap.	L	Nº	€
	mm	mm	Art.	
2	16-100	108,5	71988	62,83
3	101-125	133	71989	83,48

* Repuesto incluido / Included Spare / Rechange compris

** Accesorio opcional
Optional Accessory / Accessoire optionel

Ref. **1665**

CORONA INOX
TCT **STAINLESS** Hole Saw
Trépan **INOX**

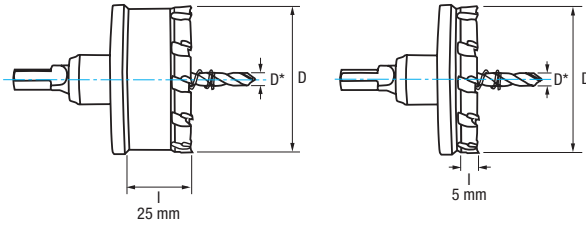

Diente MD
Carbide Tipped
Dent carbure

PVC

Fibra Vidrio
Fiberglass
Fibre de verre

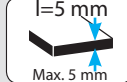
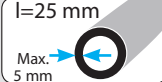

Aceros
<850 N/mm²
Steel / Aciers

INOX
Stainless Steel
Acier INOX

Plásticos
Plastics
Plastiques

D mm	l mm	Pulgadas Inches Pouces	D* mm Broca Drill Bit Foret	Nº Art.	€
16	25	5/8	6	60642	60,55
17	25	11/16	6	60643	60,55
18	25	23/32	6	13796	60,77
19	25	3/4	6	60645	60,55
20	25	25/32	6	13798	61,70
21	25	13/16	6	13799	63,70
22	25	7/8	6	13800	63,70
23	25	14/16	6	13801	64,60
24	25	15/16	6	13802	64,60
25	25	1	6	13803	64,60
26	25	1 1/32	6	13804	68,27
27	25	1 1/16	6	13805	69,39
28	25	1 3/32	6	13806	69,39
29	25	1 1/8	6	13807	69,39
30	25	1 3/16	6	13808	69,39
31	25	1 7/32	6	13809	81,64
32	25	1 1/4	6	13810	84,56
33	25	1 5/16	6	13811	84,56
34	25	1 11/32	6	13812	85,48
35	25	1 3/8	6	13813	85,48
36	25	1 13/32	6	60646	95,78
37	25	1 7/16	6	60647	95,78
38	25	1 1/2	6	13816	98,17
39	25	1 17/32	6	60648	98,17
40	25	1 9/16	6	13818	99,18
41	25	1 5/8	6	60649	107,89
42	25	1 21/32	6	13820	117,50
43	25	1 11/16	6	60652	117,50
44	25	1 3/4	6	60650	117,50
45	25	1 25/32	6	13823	120,84
50	25		6	13828	125,01
52	25	2 1/16	6	13830	145,60
53	25	2 3/32	6	13831	146,63
55	25		6	13833	146,63
60	25	2 3/8	6	13838	162,86
63	25		6	13841	205,23
65	25	2 9/16	6	60651	205,23
70	25	2 3/4	6	60653	205,48
75	25		6	60654	213,97
80	25		6	60655	224,80
85	25		6	60656	245,88
90	25		6	60657	264,13
95	25	3 3/4	6	60658	284,90
100	25	3 15/16	6	60659	303,32

D mm	l mm	Pulgadas Inches Pouces	D* mm Broca Drill Bit Foret	Nº Art.	€
14	5	9/16	6	60660	40,66
16	5	5/8	6	60661	40,66
18	5	23/32	6	60662	40,66
20	5	25/32	6	60663	40,66
22	5	7/8	6	60664	45,68
25	5	1	6	60666	45,68
30	5	1 3/16	6	60667	48,58
32	5	1 1/4	6	60668	54,52
35	5	1 3/8	6	60669	54,52
40	5	1 9/16	6	60670	60,47
45	5	1 25/32	6	60671	66,57
50	5		6	60672	72,09
60	5	2 3/8	6	60673	86,93

* **Broca y muelle incluidos**
Drill Bit & Spring included
Foret et ressort inclus

Ref. **1664**



Broca / Drill Bit / Foret

D mm	L mm	Nº Art.	€ 1 ud.
6	48	60704	3,92
6	76	60636	4,39

Muelle / Spring / Ressort

D mm	L mm	Nº Art.	€ pack
8,5	20	10 60637	0,90
8,5	35	10 60638	0,92

**Display
66**

CORONAS INOX
TCT **STAINLESS** Hole Saws
Trépan **INOX**



19 cm

∅	16	18	20	22	24	25	27	32
Pcs	1	1	1	1	1	1	1	1

Ref. 4995 - Nº Art. 71094: **529,85 €**

* **Broca y muelle incluidos**
Drill Bit & Spring included
Foret et ressort inclus

Ref. **1636**

PERFORADOR DE CHAPA

Screw Hole Punch
Perforateur de tôle

New!



HSS

Chapa
Sheets
Tôle

Aceros
<850 N/mm²
Steel / Aciers

INOX
Stainless Steel
Acier INOX

D mm	D mm Broca Drill Bit - Foret	Nº Art.	€
32,50	12,00	13671	48,79
35,00	12,00	13676	48,79

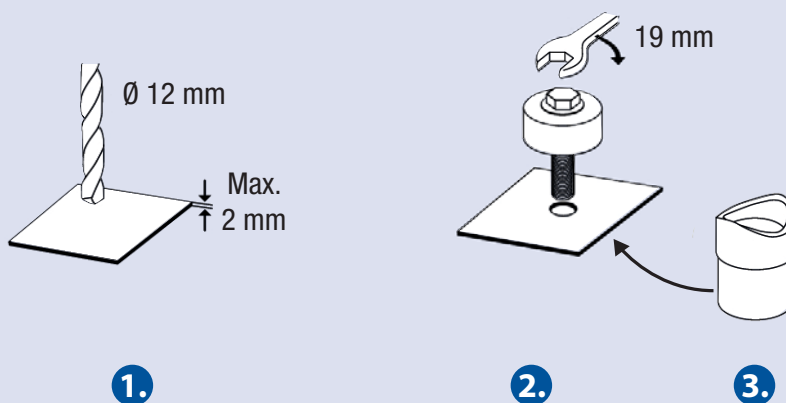

INSTRUCCIONES USO:

1. Taladrar un agujero previo con la broca
2. Introducir el tornillo por el agujero y por el lado contrario enroscar la cuchilla
3. Aplicar un par de apriete hasta seccionar la chapa

DIRECTIONS FOR USE:

1. Drill a pilot hole with the drill bit
2. Insert the screw through the hole and, on the opposite side, screw the blade
3. Apply a tightening torque until the sheet is divided

INSTRUCTIONS D'EMPLOI:

1. Percez un trou de guidage avec le foret
2. Insérez la vis dans le trou et, du côté opposé, vissez la lame
3. Appliquez un couple de serrage jusqu'à ce que la tôle soit divisée



ESCARIADORES

Reamers

Alésoirs

Ref. **2010**

ESCARIADOR MANO

Hand Reamer

Alésoir à main

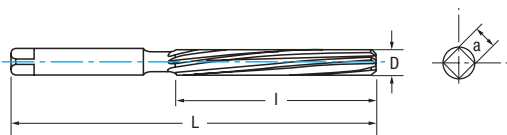

HSS

DIN
206 B

ISO
236

Tol.
H7

Aceros
<850 N/mm²
Steel / Aciers

Aluminio
Aluminium

	D mm	L mm	I mm	a mm	Nº Art.	€	D mm	L mm	I mm	a mm	Nº Art.	€	D mm	L mm	I mm	a mm	Nº Art.	€	
New!	1,00	37	12		30685	45,16	5,80	93	47	4,30	74274	25,58	10,20	133	66	8,00	74370	37,41	
New!	1,50	41	20	1,12	30689	36,25	5,90	93	47	4,30	74277	25,58	10,30	133	66	8,00	74373	37,41	
	1,60	44	21	1,25	74178	24,49	6,00	93	47	4,30	40403	19,16	10,50	133	66	8,00	40430	27,23	
	1,70	44	21	1,25	74181	24,49	6,10	100	50	4,90	74280	25,58	10,60	142	71	8,00	74379	37,41	
	1,80	47	23	1,40	74184	24,49	6,20	100	50	4,90	75172	25,58	10,70	142	71	9,00	74382	37,41	
	1,90	50	25	1,60	74187	24,49	6,30	100	50	4,90	74283	25,58	10,80	142	71	9,00	74385	37,41	
	2,00	50	25	1,60	40379	18,35	6,40	100	50	4,90	74286	25,58	11,00	142	71	9,00	40433	27,23	
	2,10	50	25	1,60	74190	24,49	6,50	100	50	4,90	40406	19,16	11,10	142	71	9,00	74391	40,27	
	2,20	54	27	1,80	74193	24,49	6,60	100	50	4,90	75233	25,58	11,20	142	71	9,00	74394	40,27	
	2,40	58	29	2,10	74199	24,49	6,70	100	50	4,90	74289	25,58	11,30	142	71	9,00	74397	40,27	
	2,50	58	29	2,10	40382	18,35	6,80	107	54	5,50	74292	25,58	11,40	142	71	9,00	74400	40,27	
	2,60	58	29	2,10	75397	24,49	6,90	107	54	5,50	74295	25,58	11,50	142	71	9,00	40436	40,27	
	2,70	62	31	2,10	74202	24,49	7,00	107	54	5,50	40409	19,16	11,60	142	71	9,00	74403	40,27	
New!	2,90	62	31	2,10	74208	24,49	7,10	107	54	5,50	74298	27,01	11,70	142	71	9,00	74406	40,27	
	2,80	62	31	2,10	74205	24,49	7,20	107	54	5,50	74301	27,01	11,80	152	76	9,00	74409	40,27	
	3,00	62	31	2,10	40385	18,35	7,30	107	54	5,50	74947	27,01	11,90	152	76	10,00	74412	40,27	
	3,10	66	33	2,40	74211	24,49	New!	7,40	107	54	5,50	74304	27,01	12,00	152	76	10,00	40439	39,51
	3,20	66	33	2,40	74214	24,49		7,50	107	54	5,50	40412	20,25	12,50	152	76	10,00	40442	50,45
	3,30	66	33	2,40	74217	24,49		7,60	115	58	6,20	74307	27,01	13,00	152	76	10,00	40445	50,45
	3,40	71	35	2,70	74220	24,49		7,80	115	58	6,20	74313	27,01	13,50	163	81	11,00	40448	66,39
	3,50	71	35	2,70	40388	19,24		7,90	115	58	6,20	74316	27,01	14,00	163	81	11,00	40451	53,89
	3,60	71	35	2,70	74223	24,49		8,00	115	58	6,20	40415	20,25	14,50	163	81	11,00	40454	58,86
	3,70	71	35	2,70	74226	24,49		8,10	115	58	6,20	74319	28,36	15,00	163	81	11,00	40457	58,86
	3,80	76	38	3,00	75398	24,49		8,20	115	58	6,20	74322	28,36	15,50	175	87	12,00	40460	64,02
	3,90	76	38	3,00	74229	24,49		8,30	115	58	6,20	74325	28,36	16,00	175	87	12,00	40463	64,02
	4,00	76	38	3,00	40391	18,35		8,50	115	58	6,20	40418	21,23	16,50	175	87	12,00	40466	81,12
	4,10	76	38	3,00	74232	25,58		8,60	124	62	7,00	74331	28,36	17,00	175	87	12,00	40469	77,10
	4,20	76	38	3,00	74235	25,58		8,80	124	62	7,00	74337	28,36	17,50	188	93	14,50	40472	86,09
	4,30	81	41	3,40	74238	25,58		8,90	124	62	7,00	74340	28,36	18,00	188	93	14,50	40475	92,45
	4,40	81	41	3,40	74241	25,58		9,00	124	62	7,00	40421	23,34	18,50	188	93	14,50	40478	92,45
	4,50	81	41	3,40	40394	19,16		9,10	124	62	7,00	74343	29,60	19,00	188	93	14,50	40481	92,45
	4,70	81	41	3,40	74247	25,58		9,20	124	62	7,00	74346	29,60	20,00	201	100	16,00	40487	94,65
	4,80	87	44	3,80	74250	25,58		9,30	124	62	7,00	74349	29,60	21,00	201	100	16,00	40493	94,65
	4,90	87	44	3,80	74253	25,58		9,40	124	62	7,00	74352	29,60	22,00	215	107	18,00	40499	98,07
	5,00	87	44	3,80	40397	19,16		9,50	124	62	7,00	40424	24,36	23,00	215	107	18,00	40505	102,44
	5,10	87	44	3,80	74256	25,58		9,60	133	66	8,00	74355	29,60	24,00	231	115	20,00	40511	113,11
	5,20	87	44	3,80	74259	25,58		9,70	133	66	8,00	74358	29,60	25,00	231	115	20,00	40517	120,06
	5,30	87	44	3,80	74262	25,58		9,80	133	66	8,00	74361	29,60	26,00	231	115	20,00	40523	131,20
	5,40	93	47	4,30	74265	25,58		9,90	133	66	8,00	74364	29,60	27,00	247	124	22,40	40529	143,05
	5,50	93	47	4,30	40400	19,16		10,00	133	66	8,00	40427	24,36	28,00	247	124	22,40	40535	148,06
	5,60	93	47	4,30	74268	25,58		10,10	133	66	8,00	74367	37,41	30,00	247	124	22,40	40547	195,96
	5,70	93	47	4,30	74271	25,58													

Ref. **2015**

ESCARIADOR MANO EXTENSIBLE REFORZADO

Reinforced Rapidly Adjustable Hand Reamer
Alésoir à lames réglables renforcée



HSS

Aceros
<850 N/mm²
Steel / Aciers

Aluminio
Aluminium



Cap. mm	L mm	I mm	Z	Nº Art.	€
06,40-07,20	85	34	4	21076	95,00
07,20-08,00	90	35	4	21077	95,00
08,00-09,00	100	39	5	21079	95,00
09,00-10,00	120	45	5	21080	95,00
10,00-11,00	125	45	5	21081	95,00
11,00-12,00	130	46	5	21082	95,00
12,00-13,50	135	48	5	21084	95,00
13,50-15,50	140	58	5	21085	95,00
15,50-18,00	165	69	5	21086	101,08
18,00-21,00	185	75	5	21087	104,63

Cap. mm	L mm	I mm	Z	Nº Art.	€
21,00-24,00	195	80	5	21088	121,73
24,00-27,50	215	90	6	21089	132,53
27,50-31,50	240	100	6	21090	144,91
31,50-37,00	265	110	6	21091	188,92
37,00-45,00	310	130	6	21092	281,72
45,00-55,00	380	145	6	21093	405,28
55,00-67,00	152	440	6	21094	582,98

Ref. **2016**

ESCARIADOR MANO EXTENSIBLE CON GUÍA

Guided Rapidly Adjustable Hand Reamer
Alésoir à lames réglables avec guide



HSS

Aceros
<850 N/mm²
Steel / Aciers

Aluminio
Aluminium



Cap. mm	L mm	I mm	Z	Nº Art.	€
08,00-09,00	175	39	5	21346	110,93
09,00-10,00	185	39	5	21347	110,93
10,00-11,00	195	45	5	21348	110,93
11,00-12,00	200	45	5	21350	110,93
12,00-13,50	220	48	5	21351	113,14
13,50-15,50	243	58	5	21352	117,67
15,50-18,00	274	69	5	21353	123,21
18,00-21,00	300	75	5	21354	131,03

Cap. mm	L mm	I mm	Z	Nº Art.	€
21,00-24,00	320	80	6	21355	149,87
24,00-27,50	350	90	6	21356	167,71
27,50-31,50	385	100	6	21357	188,84
31,50-37,00	424	110	6	21358	260,22
37,00-45,00	490	130	6	21360	364,40
45,00-55,00	600	145	6	21363	522,30

Ref. **2017**

CUCHILLA ESCARIADOR MANO EXTENSIBLE

Adjustable Hand Reamer Blade
Lame pour alésoir réglable à main



HSS

Aceros
<850 N/mm²
Steel / Aciers

Aluminio
Aluminium

Cap. mm	L mm	C	Nº Art.	€ pack
06,40-07,20	34,00	4	49927	47,59
07,20-08,00	35,00	4	49928	47,59
08,00-09,00	39,00	5	49929	47,59
09,00-10,00	44,50	5	49930	47,59
10,00-11,00	45,00	5	49931	47,59
11,00-12,00	46,50	5	49932	47,59
12,00-13,50	48,00	5	26516	47,59
13,50-15,50	54,00	5	49933	47,59
15,50-18,00	69,00	5	43410	49,84

Cap. mm	L mm	C	Nº Art.	€ pack
18,00-21,00	75,00	5	19594	52,52
21,00-24,00	80,00	5	49934	60,31
24,00-27,50	90,00	6	22499	63,64
27,50-31,50	100,00	6	22500	70,03
31,50-37,00	110,00	6	49935	86,14
37,00-45,00	130,00	6	28820	133,32
45,00-55,00	145,00	6	49936	205,04
55,00-67,00	174,00	6	51333	323,13



AVELLANADORES

Countersinks / Counterbores

Outils

Ref. **2575**

AVELLANADOR MANGO CILÍNDRICO 90°

90° Straight Shank Countersink

Fraise à noyer 90°

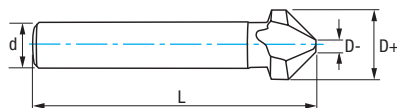

HSSE 5% Co	DIN 335 C	α 90°	3 Z	Tol. D (±0,05)	Tol. d (h9)	Tol. L (± 1)	Tol. α ⁰ -1
---------------	--------------	-------	-----	-------------------	----------------	-----------------	---------------------------

Aceros
<850 N/mm²
Steel / Aciers

INOX
Stainless Steel
Acier INOX

Cobre
Copper
Cuivre

Aluminio
Aluminium

Termoplásticos
Thermoplastics
Thermoplastiques

D+ mm	D- mm	d mm	L mm	Nº Art.	€
4,30	1,30	4,00	40	74653	13,49
5,00	1,50	4,00	40	74654	13,08
5,30	1,50	4,00	40	74655	13,38
5,80	1,50	5,00	45	74656	13,68
6,00	1,50	5,00	45	74657	13,68
6,30	1,50	5,00	45	74658	13,21
7,00	1,80	6,00	50	74659	13,36
7,30	1,80	6,00	50	74660	13,54
8,00	2,00	6,00	50	74661	14,29
8,30	2,00	6,00	50	74662	14,44
9,40	2,20	6,00	50	74663	15,06
10,00	2,50	6,00	50	74664	15,80
10,40	2,50	6,00	50	74665	18,83
11,50	2,80	8,00	56	74666	17,49
12,40	2,80	8,00	56	74667	18,08
13,40	2,90	8,00	56	74668	19,76
15,00	3,20	10,00	60	74669	22,33
16,50	3,20	10,00	60	74670	25,63
19,00	3,50	10,00	63	74671	33,42
20,50	3,50	10,00	63	74672	34,20
23,00	3,80	10,00	67	74673	41,80
25,00	3,80	10,00	67	74674	44,85
28,00	4,00	12,00	71	42714	62,82
30,00	4,20	12,00	71	12588	67,20
31,00	4,20	12,00	71	42715	67,20
40,00	5,00	15,00	80	11061	122,21



Set 6 Pcs

Cont. Ø	Nº Art.	€
6,3-8,3-10,4- 12,4-16,5-20,5	40515	124,37

Recubrimiento bajo demanda / Coating upon request / Revêtement sur demande

Línea 33 cm
2575

AVELLANADOR MANGO CILÍNDRICO 90°

90° Straight Shank Countersink

Fraise à noyer 90°



ø	5	6	7	10	12,4	15
Pcs	2	2	2	2	2	2

Ref. 4995 - Nº Art. 70987: 192,67 €

Ref. **2530**

AVELLANADOR MANGO CILÍNDRICO ALLEN

Allen Straight Shank Counterbore
Fraise à lamer et chambrer

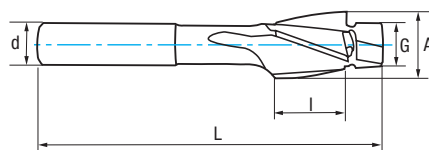

HSS	DIN 373	ISO 4206	Allen		Tol. A z9	Tol. G e8	Tol. d h9	Aluminio Aluminium >10% Si
Aceros <850 N/mm ² Steel / Aciers	Aceros <1000 N/mm ² Steel / Aciers	INOX Ferríticos-Martensíticos Ferritic-Martensitic Stainless INOX Ferritiques-Martensitiques	Fundición Cast Iron Fonte	Titanio Titanium Titane	Cobre Copper Cuivre			



M	A mm	G mm	d mm	L mm	I mm	Z	Nº Art.	€
M3	6,50	3,40	5,00	71	14	3	42029	20,16
M4	8,00	4,50	5,00	71	14	3	42032	20,16
M5	10,00	5,50	8,00	80	18	3	42035	20,16
M6	11,00	6,60	8,00	80	18	3	42038	22,72
M8	15,00	9,00	12,50	100	22	3	42041	28,12
M10	18,00	11,00	12,50	100	22	3	42044	33,47
M12	20,00	13,50	12,50	100	22	3	42047	39,62
M14	24,00	15,50	16,00	100	22	4	42050	59,22
M16	26,00	17,50	16,00	100	22	4	42053	65,48



Set 6 Pcs

Cont.	Nº Art.	€
M3-M4-M5-M6-M8-M10	40512	144,81

Línea 33 cm
2530

AVELLANADOR MANGO CILÍNDRICO ALLEN

Allen Straight Shank Counterbore
Fraise à lamer et chambrer



∅	M5	M6	M8	M10	M12
Pcs	1	1	1	1	1

Ref. 4995 - Nº Art. 72112: 144,11 €

Ref. **2572**

AVELLANADOR MANGO CILÍNDRICO 90°

90° Straight Shank Countersink
Fraise à ebavurer 90°

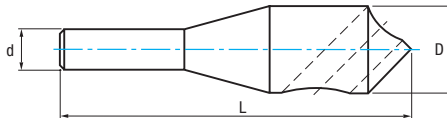

HSSE 5% Co	IZAR Std.	α 90°	Tol. D +0 +0,3	Tol. d (h9)	Tol. L (\pm 1)	Tol. α 0 -1
----------------------	--------------	--------------	----------------------	----------------	----------------------	-----------------------

Aceros
<850 N/mm²
Steel / Aciers

INOX Ferríticos-Martensíticos
Ferritic-Martensitic Stainless
INOX Ferritiques-Martensitiques

Aluminio
Aluminium



Aplic. mm	D mm	d mm	L mm	N° Art.	€
2-5	10,00	6,00	46	69183	23,49
5-10	14,00	8,00	55	69181	31,70
10-15	20,00	10,00	65	69184	58,65
15-20	28,00	12,00	85	69187	111,53
20-25	30,00	15,00	95	69186	158,50



Set 4 Pcs

Aplic. mm	N° Art.	€
2-5, 5-10, 10-15, 15-20	40513	225,38

Línea 33 cm
2572

AVELLANADOR MANGO CILÍNDRICO 90°

90° Straight Shank Countersink
Fraise à ebavurer 90°



\varnothing	2-5	5-10	10-15	15-20	20-25
Pcs	1	1	1	1	1

Ref. 4995 - N° Art. 72115: **383,88 €**

MACHOS Y COJINETES

Taps & Dies
Tarauds et Filières

Ref. **3030**

JUEGO MACHOS MANO MÉTRICA

Metric Hand Tap Set
Jeu de tarauds à main métrique

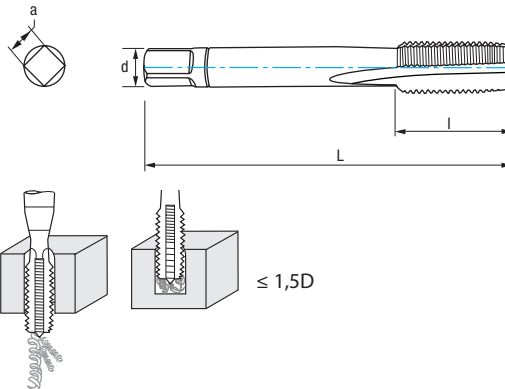

M	P	L mm	l mm	d mm	a mm	Z	Nº Art.	€	M	P	L mm	l mm	d mm	a mm	Z	Nº Art.	€
M2	0,40	36	8	2,80	2,10	3	62531	28,32	M15	2,00	80	32	12,00	9,00	4	62588	79,27
M2,5	0,45	40	9	2,80	2,10	3	62534	28,32	M16	2,00	80	32	12,00	9,00	4	62591	56,26
M3	0,50	40	11	3,50	2,70	3	62537	16,03	M18	2,50	95	34	14,00	11,00	4	62594	74,56
M3,5	0,60	45	13	4,00	3,00	3	62540	18,88	M20	2,50	95	34	16,00	12,00	4	62597	84,01
M4	0,70	45	13	4,50	3,40	3	62543	16,03	M22	2,50	100	34	18,00	14,50	4	62603	112,33
M4	0,75	45	14	4,50	3,40	3	76377	27,75	M24	3,00	110	50	18,00	14,50	4	62606	131,64
M4,5	0,75	50	16	6,00	4,90	3	62546	28,32	M27	3,00	110	50	20,00	16,00	4	62609	169,41
M5	0,80	50	16	6,00	4,90	3	62549	16,99	M30	3,50	125	50	22,00	18,00	4	62612	217,05
M6	1,00	56	19	6,00	4,90	3	62552	16,99	M33	3,50	125	50	25,00	20,00	4	62615	273,69
M7	1,00	56	19	6,00	4,90	3	62555	20,77	M36	4,00	150	56	28,00	22,00	4	62618	349,16
M8	1,25	56	22	6,00	4,90	4	62561	20,77	M39	4,00	150	60	32,00	24,00	4	62621	390,74
M9	1,25	63	22	7,00	5,50	4	62567	33,97	M42	4,50	150	60	32,00	24,00	4	62624	488,87
M10	1,50	70	24	7,00	5,50	4	62573	25,50	M45	4,50	160	65	36,00	29,00	6	73760	564,38
M11	1,50	70	24	8,00	6,20	4	62576	42,46	M48	5,00	180	70	36,00	29,00	6	62627	679,50
M12	1,75	75	28	9,00	7,00	4	62579	35,85	M52	5,00	180	70	40,00	32,00	6	76382	824,86
M13	1,75	75	28	9,00	7,00	4	62582	65,11	M56	5,50	180	70	40,00	32,00	6	76383	1.272,04
M14	2,00	80	30	11,00	9,00	4	62585	39,65	M60	5,50	200	85	45,00	35,00	6	76384	1.592,06

Macho único Ref. 3010 disponible en [pag. 128](#)

Single Tap Ref. 3010 available in [page 128](#)

Taraud unique Ref. 3010 disponible [pag. 128](#)

Ref. **3003**

JUEGO MACHOS MANO MÉTRICA

Metric Hand Tap Set
Jeu de tarauds à main métrique

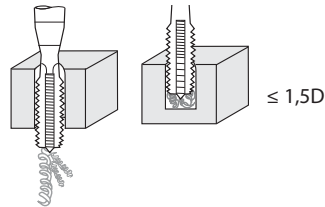
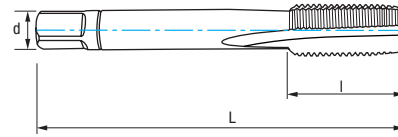

Aceros
<math><850 \text{ N/mm}^2</math>
Steel / Aciers

Fundición
Cast Iron
Fonte

Cobre
Copper
Cuivre

Aluminio
Aluminium



M	P	L mm	l mm	d mm	a mm	Z	Nº Art.	€
M3	0,50	40	11	3,50	2,70	3	42876	16,35
M4	0,70	45	13	4,50	3,40	3	42879	16,35
M5	0,80	50	16	6,00	4,90	3	42882	17,32
M6	1,00	56	19	6,00	4,90	3	42884	17,32
M7	1,00	56	19	6,00	4,90	3	42885	21,17
M8	1,25	63	22	6,00	4,90	4	42886	21,17
M10	1,50	70	24	7,00	5,50	4	42887	26,00
M12	1,75	75	28	9,00	7,00	3	42888	36,55
M14	2,00	80	30	11,00	9,00	4	42889	40,42
M16	2,00	80	32	12,00	9,00	4	42890	57,36
M18	2,50	95	34	14,00	11,00	4	42891	76,01
M20	2,50	95	34	16,00	12,00	4	42892	85,63

Macho único Ref. 3001 disponible en [pag. 130](#)

Single Tap Ref. 3001 available in [page 130](#)

Taraud unique Ref. 3001 disponible [pag. 130](#)

Línea 33 cm
3003

JUEGO MACHOS MANO MÉTRICA

Metric Hand Tap Set
Jeu de tarauds à main métrique



ø	M3	M5	M6	M10	M12
Pcs	3	3	3	3	3

Ref. 4995 - Nº Art. 70990: 340,59 €

Display 22



JUEGO MACHOS MANO MÉTRICA

Metric Hand Tap Set

Jeu de tarauds à main métrique

∅	M20	Mod. 01	Mod. 02	Mod. 10	Mod. 20		
Pcs	1	1	1	1	1		
∅	M12	M14	M16	M18			
Pcs	2	1	1	1			
∅	M-3	M-4	M-5	M-6	M-7	M-8	M10
Pcs	2	2	2	2	2	2	2

Ref. 4995 - N° Art. 22298: **733,99 €**

Display 44



26
cm

JUEGO MACHOS MANO MÉTRICA

Metric Hand Tap Set

Jeu de tarauds à main métrique

∅	M-4	M-5	M-6	M-8	M-10	01
Pcs	2	2	2	2	2	2

Ref. 4995 - N° Art. 42490: **241,04 €**

Ref. **3036**

JUEGO MACHOS MANO MÉTRICA/ MÉTRICA FINA COBALTO INOX

STAINLESS Cobalt Metric / Metric Fine Hand Tap Set

Jeu de tarauds à main métrique / métrique pas fin Cobalt INOX

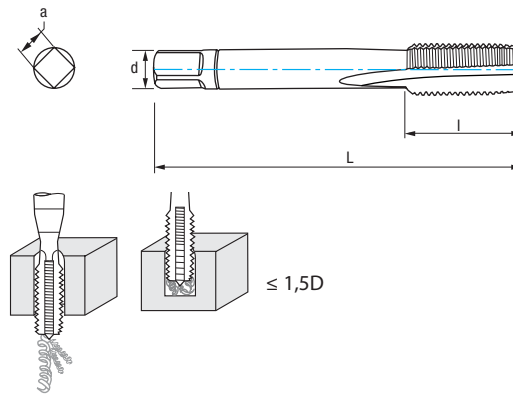

HSSE
5% Co

M
DIN
352

MF
DIN
2181

Tol.
6H

Vaporiz.

C
2-3h

α
6-8°



Vaporizado
Vaporized
Vaporisée

Grupo
Group-Gruppe
P

Subgrup.
P.5

INOX
Stainless Steel
Acier INOX

Fundición
Cast Iron
Fonte

Nº1 Desbaste
Roughing
Ébauche

Nº2 Semidesbaste
Semiroughing
Semi-ébauche

Nº3 Acabado
Finishing
Finition

Nº1-Nº2 Con guía
Guided
Avec guide

M	P	L mm	l mm	d mm	a mm	Z	Nº Art.	€
M2	0,40	36	8	2,80	2,10	3	69229	37,04
M3	0,50	40	11	3,50	2,70	3	16404	29,63
M4	0,70	45	13	4,50	3,40	3	16405	29,63
M5	0,80	50	16	6,00	4,90	3	16406	30,85
MF6	0,75	56	14	6,00	4,90	3	82254	57,34
M6	1,00	56	19	6,00	4,90	3	16407	30,85
MF8	1,00	63	18	6,00	4,90	3	82255	57,34
M8	1,25	63	22	6,00	4,90	3	16408	35,83
MF10	1,00	63	18	7,00	5,50	3	82256	63,66
M10	1,50	70	24	7,00	5,50	3	16409	46,08
MF12	1,00	70	18	9,00	7,00	3	82257	72,71
MF12	1,50	70	22	9,00	7,00	3	82258	71,03
M12	1,75	75	29	9,00	7,00	3	16410	65,94
MF14	1,50	70	22	11,00	9,00	4	82259	88,52
M14	2,00	80	30	11,00	9,00	4	16411	73,03
MF16	1,50	70	22	12,00	9,00	4	82290	91,70
M16	2,00	80	32	12,00	9,00	4	16412	100,09
MF18	1,50	80	22	14,00	11,00	4	82260	133,86
M18	2,50	95	40	14,00	11,00	4	16413	136,71
MF20	1,50	80	22	16,00	12,00	4	82261	130,27
M20	2,50	95	40	16,00	12,00	4	16414	151,79



Ref. **3037**

MACHO ÚNICO MÉTRICA/ MÉTRICA FINA COBALTO INOX

STAINLESS Cobalt Metric / Metric Fine Hand Single Tap

Taraud à main unique métrique / métrique pas fin Cobalt INOX

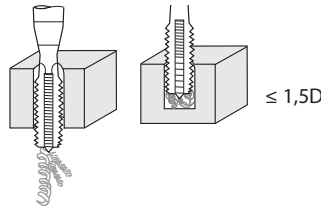
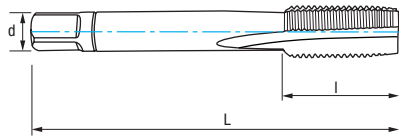

HSSE 5% Co	M DIN 352	MF DIN 2181	Tol. 6H	Vaporiz.	C 2-3h	α 6-8°	60°
---------------	-----------------	-------------------	------------	----------	-----------	------------------	-----

Grupo Group-Gruppe P	Subgrup. P.5	INOX Stainless Steel Acier INOX	Fundición Cast Iron Fonte	Nº1 Desbaste Roughing Ébauche	Nº2 Semidesbaste Semiroughing Semi-ébauche	Nº3 Acabado Finishing Finition	Nº1-Nº2 Con guía Guided Avec guide
-----------------------------------	------------------------	---------------------------------------	---------------------------------	-------------------------------------	--	--------------------------------------	--

M	P	L mm	l mm	d mm	a mm	Z	Nº 3 Acabado Finishing Finition	Nº 1 Desbaste Roughing Ébauche	Nº 2 Semidesbaste Semiroughing Semi-Ébauche	€
M2	0,40	36	8	2,80	2,10	3	83127	83125	83126	12,58
M3	0,50	40	11	3,50	2,70	3	74981	74979	74980	10,07
M4	0,70	45	13	4,50	3,40	3	75010	74982	74983	10,07
M5	0,80	50	16	6,00	4,90	3	74986	74984	74985	10,48
MF6	0,75	56	14	6,00	4,90	3	82264	82262		28,65
M6	1,00	56	19	6,00	4,90	3	74990	74988	74989	10,48
MF8	1,00	63	18	6,00	4,90	3	82267	82265		28,65
M8	1,25	63	22	6,00	4,90	3	74993	74991	74992	12,18
MF10	1,00	63	18	7,00	5,50	3	82270	82268		31,85
M10	1,50	70	24	7,00	5,50	3	74998	74994	74997	15,67
MF12	1,00	70	18	9,00	7,00	3	82273	82271		36,38
MF12	1,50	70	22	9,00	7,00	3	82276	82274		35,52
M12	1,75	75	29	9,00	7,00	3	75003	74999	75000	22,42
MF14	1,50	70	22	11,00	9,00	4	82279	82277		44,27
M14	2,00	80	30	11,00	9,00	4	75006	75004	75005	24,84
MF16	1,50	70	22	12,00	9,00	4	82283	82280		45,84
M16	2,00	80	32	12,00	9,00	4	74974	72865	72864	34,04
MF18	1,50	80	22	14,00	11,00	4	82286	82284		66,89
M18	2,50	95	40	14,00	11,00	4	75009	75007	75008	46,49
MF20	1,50	80	22	16,00	12,00	4	82289	82287		65,15
M20	2,50	95	40	16,00	12,00	4	59960	74131	74977	51,61



Ref. **3020**

JUEGO MACHOS MANO MÉTRICA FINA

Metric Fine Hand Tap Set

Jeu de tarauds à main métrique pas fin

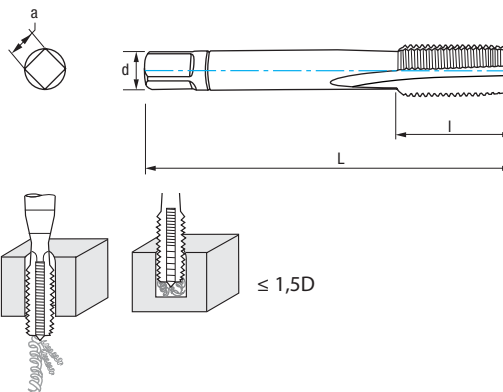

HSS	DIN 2181	Tol. 6H	C 2-3h	α 10° ± 2	60°	N°1 Desbaste Roughing Ébauche	N°3 Acabado Finishing Finition
-----	----------	---------	--------	------------------	-----	-------------------------------	--------------------------------

Aceros <850 N/mm ² Steel / Aciers	Fundición Cast Iron Fonte	Cobre Copper Cuivre	Aluminio Aluminium
---	--	----------------------------------	------------------------------

MF	P	L mm	l mm	d mm	a mm	Z	Nº Art.	€
MF4	0,50	45	10	4,50	3,40	3	62336	31,91
MF5	0,50	50	12	6,00	4,90	3	62342	31,75
MF5	0,75	50	12	6,00	4,90	3	62345	32,11
MF6	0,50	50	14	6,00	4,90	3	62351	22,68
MF6	0,75	50	14	6,00	4,90	3	62354	19,21
MF7	0,75	50	14	6,00	4,90	3	62360	29,23
MF8	0,50	50	19	6,00	4,90	4	62366	43,49
MF8	0,75	50	19	6,00	4,90	4	62369	26,40
MF8	1,00	56	20	6,00	4,90	4	62372	19,13
MF9	1,00	63	20	7,00	5,50	4	75090	32,46
MF10	0,50	63	20	7,00	5,50	4	21727	41,48
MF10	0,75	63	20	7,00	5,50	4	76309	49,09
MF10	1,00	63	20	7,00	5,50	4	62378	20,61
MF10	1,25	70	24	7,00	5,50	4	62381	20,87
MF11	0,75	63	20	8,00	6,20	4	16118	101,71
MF11	1,00	63	20	8,00	6,20	4	76311	45,26
MF11	1,25	63	20	8,00	6,20	4	75298	45,26
MF12	0,75	70	22	9,00	7,00	4	76312	56,21
MF12	1,00	70	20	9,00	7,00	4	62387	36,04
MF12	1,25	70	22	9,00	7,00	4	62390	36,11
MF12	1,50	70	22	9,00	7,00	4	62393	30,78
MF13	0,75	70	22	11,00	9,00	4	56832	101,71
MF13	1,00	70	20	11,00	9,00	4	76314	64,38
MF13	1,25	70	22	11,00	9,00	4	76315	56,88
MF13	1,50	70	22	11,00	9,00	4	62399	56,88
MF14	0,75	70	22	11,00	9,00	4	56833	100,13
MF14	1,00	70	20	11,00	9,00	4	62402	64,38
MF14	1,25	70	20	11,00	9,00	4	62405	44,11
MF14	1,50	70	20	11,00	9,00	4	62408	34,27
MF14	1,75	70	30	11,00	9,00	4	10875	131,45
MF15	1,00	70	20	12,00	9,00	4	76318	90,09
MF15	1,25	70	22	12,00	9,00	4	76319	82,10
MF15	1,50	70	20	12,00	9,00	4	75299	83,45
MF16	1,00	70	20	12,00	9,00	4	62414	90,14
MF16	1,25	70	20	12,00	9,00	4	76320	94,89
MF16	1,50	70	20	12,00	9,00	4	62417	42,90

MF	P	L mm	l mm	d mm	a mm	Z	Nº Art.	€
MF17	1,00	70	22	12,00	9,00	4	76321	121,01
MF17	1,25	70	22	12,00	9,00	4	56834	121,01
MF17	1,50	70	22	12,00	9,00	4	62420	121,01
MF18	1,00	80	22	14,00	11,00	4	62423	100,24
MF18	1,25	80	22	14,00	11,00	4	76323	119,27
MF18	1,50	80	22	14,00	11,00	4	62426	56,66
MF18	2,00	80	22	14,00	11,00	4	62429	106,94
MF19	1,00	80	22	14,00	11,00	4	10831	175,63
MF19	1,25	80	22	14,00	11,00	4	56835	175,49
MF19	1,50	80	22	14,00	11,00	4	76326	175,63
MF19	2,00	80	22	14,00	11,00	4	56837	209,21
MF20	1,00	80	22	16,00	12,00	4	76327	132,79
MF20	1,25	80	22	16,00	12,00	4	74816	175,63
MF20	1,50	80	22	16,00	12,00	4	62435	71,03
MF20	2,00	80	22	16,00	12,00	4	62438	111,35
MF21	1,00	80	22	16,00	12,00	4	56838	226,97
MF21	1,25	80	22	16,00	12,00	4	56840	226,97
MF21	1,50	80	22	16,00	12,00	4	75300	179,48
MF22	1,00	80	22	18,00	14,50	4	76330	148,83
MF22	1,25	80	22	18,00	14,50	4	74601	175,63
MF22	1,50	80	22	18,00	14,50	4	62441	77,45
MF22	2,00	80	22	18,00	14,50	4	62444	124,01
MF23	1,00	80	22	18,00	14,50	4	56841	226,74
MF23	1,50	80	22	18,00	14,50	4	56842	226,74
MF24	1,00	90	22	18,00	14,50	4	76333	139,37
MF24	1,25	90	22	18,00	14,50	4	62447	226,97
MF24	1,50	90	22	18,00	14,50	4	62450	98,85
MF24	2,00	90	22	18,00	14,50	4	62453	166,39
MF25	1,00	90	22	18,00	14,50	4	76334	198,59
MF25	1,25	90	22	18,00	14,50	4	56843	323,36
MF25	1,50	90	22	18,00	14,50	4	75301	195,12
MF25	2,00	90	22	18,00	14,50	4	56844	332,60
MF26	1,00	90	22	18,00	14,50	4	56846	173,54
MF26	1,50	90	22	18,00	14,50	4	75302	188,34
MF26	2,00	90	22	18,00	14,50	4	56847	191,04
MF27	1,00	90	22	20,00	16,00	4	76338	191,08

Cont.

Ref. **3020**

JUEGO MACHOS MANO MÉTRICA FINA

Metric Fine Hand Tap Set

Jeu de tarauds à main métrique pas fin

Cont.

MF	P	L mm	l mm	d mm	a mm	Z	Nº Art.	€
MF27	1,50	90	22	20,00	16,00	4	76339	207,65
MF27	2,00	90	22	20,00	16,00	4	75303	230,67
MF28	1,00	90	22	20,00	16,00	4	76340	323,66
MF28	1,50	90	22	20,00	16,00	4	76341	209,20
MF30	1,00	90	22	22,00	18,00	4	76342	200,83
MF30	1,50	90	22	22,00	18,00	4	76343	216,99
MF30	2,00	90	22	22,00	18,00	4	75304	250,12
(New!) MF30	3,00	90	22	22,00	18,00	4	14421	250,12
MF32	1,50	90	22	22,00	18,00	4	76345	250,51
MF33	1,50	100	25	25,00	20,00	4	76348	294,45
MF33	2,00	100	25	25,00	20,00	4	75305	371,86
MF34	1,50	100	25	28,00	22,00	4	76349	306,89
MF35	1,50	100	25	28,00	22,00	4	76350	306,89
MF36	1,50	100	25	28,00	22,00	4	76351	338,01
MF36	2,00	125	33	28,00	22,00	4	76140	432,53
MF36	3,00	125	33	28,00	22,00	4	76352	496,23
MF38	1,50	100	25	28,00	22,00	4	76353	380,15
MF38	2,00	125	40	28,00	22,00	4	75306	451,89
MF39	1,50	110	25	32,00	24,00	4	76354	496,23
MF39	2,00	125	33	32,00	24,00	4	76355	592,67
MF39	3,00	125	33	32,00	24,00	4	76356	496,23
MF40	1,50	110	25	32,00	24,00	6	76357	446,56
MF40	2,00	110	25	32,00	24,00	6	76358	436,15
MF40	3,00	125	40	32,00	24,00	6	76359	432,10
MF42	2,00	125	33	32,00	24,00	6	76361	593,47
MF42	3,00	125	33	32,00	24,00	6	76362	593,47
MF45	1,50	110	25	36,00	29,00	6	76363	467,59
MF45	2,00	125	33	36,00	29,00	6	76364	712,49
MF45	3,00	125	33	36,00	29,00	6	76365	763,87
MF48	1,50	140	33	36,00	29,00	6	76366	526,90
MF48	2,00	140	33	36,00	29,00	6	76367	863,36
MF48	3,00	140	33	36,00	29,00	6	76368	863,42
MF50	1,50	140	40	36,00	29,00	6	76369	576,23
MF52	1,50	140	40	40,00	32,00	6	76370	611,28
MF52	2,00	140	40	40,00	32,00	6	77643	879,43
MF52	3,00	140	40	40,00	32,00	6	76372	816,49



Ref. **3010**

MACHO ÚNICO MANO MÉTRICA/ MÉTRICA FINA

Metric / Metric Fine Hand **Single Tap**

Taroud à main **unique** métrique / métrique pas fin

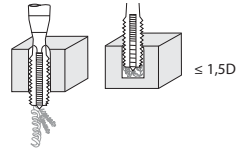
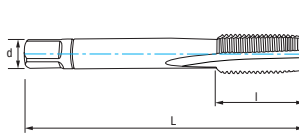

HSS

M
DIN
352

MF
DIN
2181

Tol.
6H

C
2-3h

α
10° ± 2

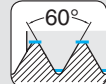

Aceros
<850 N/mm²
Steel / Aciers

Fundición
Cast Iron
Fonte

Cobre
Copper
Cuivre

Aluminio
Aluminium

Nº3 Acabado
Finishing Finition
(M Ref. 3030 / MF Ref. 3020)

Nº 1 Desbaste M
Roughing Ébauche
(Ref. 3030)

Nº 2 Semidesbaste M
Semiroughing Semi-ébauche
(Ref. 3030)



M/MF	P	L mm	l mm	d mm	a mm	Z	Nº Art. HSS	€	Nº Art. HSS	€	Nº Art. HSS	€
M2	0,40	36	8	2,80	2,10	3	76385	9,68	22710	9,68	33368	9,68
M2	0,45	41	8	2,50	2,00	3	16451	9,68				
M2,5	0,45	40	9	2,80	2,10	3	76387	9,68				
M3	0,50	40	11	3,50	2,70	3	76389	5,50	11158	5,50	12723	5,50
M3,5	0,60	45	13	4,00	3,00	3	76391	6,50	66186	6,50	20538	6,50
MF4	0,50	45	10	4,50	3,40	3	76393	15,95				
M4	0,70	45	13	4,50	3,40	3	76394	5,50	18943	5,50	11263	5,50
M4,5	0,75	50	16	6,00	4,90	3	76397	9,70	66187	9,70	66192	9,70
MF5	0,50	50	12	6,00	4,90	3	59484	16,86				
MF5	0,75	50	12	6,00	4,90	3	59485	15,97				
M5	0,80	50	16	6,00	4,90	3	76400	5,84	11262	5,84	26620	5,84
MF6	0,50	50	14	6,00	4,90	3	59486	11,60				
MF6	0,75	50	14	6,00	4,90	3	76405	9,60				
M6	1,00	50	19	6,00	4,90	3	75383	5,84	10630	5,84	10833	5,84
MF7	0,75	50	14	6,00	4,90	3	46217	14,62				
M7	1,00	50	19	6,00	4,90	3	76408	7,13	66201	7,13	32812	7,13
MF8	0,50	50	19	6,00	4,90	4	59487	17,98				
MF8	0,75	50	19	6,00	4,90	4	59488	14,24				
MF8	1,00	56	20	6,00	4,90	4	76411	9,57				
M8	1,25	56	22	6,00	4,90	4	75449	7,13	10938	7,13	26629	7,13
MF9	1,00	63	20	7,00	5,50	4	34577	16,23				
M9	1,25	63	22	7,00	5,50	4	76414	11,64	66208	11,64	20543	11,64
MF10	0,50	63	20	7,00	5,50	4	59489	20,74				
MF10	0,75	63	20	7,00	5,50	4	59490	20,25				
MF10	1,00	63	20	7,00	5,50	4	76417	10,29				
MF10	1,25	70	24	7,00	5,50	4	76418	10,44				
M10	1,50	70	24	7,00	5,50	4	74995	8,73	11148	8,73	15086	8,73
MF11	0,75	63	20	8,00	6,20	4	59491	50,02				
MF11	1,00	63	20	8,00	6,20	4	59492	18,00				
MF11	1,25	63	22	8,00	6,20	4	59493	18,15				
M11	1,50	70	24	8,00	6,20	4	76422	14,59	25211	14,59	21282	14,59
MF12	0,75	70	22	9,00	7,00	4	59494	28,81				
MF12	1,00	70	20	9,00	7,00	4	22221	18,04				
MF12	1,25	70	22	9,00	7,00	4	76425	18,07				
MF12	1,50	70	22	9,00	7,00	4	76426	15,40				
M12	1,75	75	29	9,00	7,00	4	74996	12,31	10834	12,31	28407	12,31
MF13	0,75	70	22	11,00	9,00	4	59495	51,07				
MF13	1,00	70	20	11,00	9,00	4	59496	28,91				
MF13	1,25	70	22	11,00	9,00	4	59497	29,14				
MF13	1,50	70	22	11,00	9,00	4	59498	29,20				
MF14	0,75	70	22	11,00	9,00	4	59499	50,48				
MF14	1,00	70	20	11,00	9,00	4	76433	32,18				
MF14	1,25	70	20	11,00	9,00	4	45040	22,05				
MF14	1,50	70	20	11,00	9,00	4	76435	17,14				
MF14	1,75	70	30	11,00	9,00	4	59500	65,73				
M14	2,00	80	30	11,00	9,00	4	76436	13,60	11772	13,60	20529	13,60
MF15	1,00	70	20	12,00	9,00	4	59501	39,01				
MF15	1,25	70	22	12,00	9,00	4	59503	41,74				
MF15	1,50	70	20	12,00	9,00	4	76439	41,73				
MF16	1,00	70	22	12,00	9,00	4	59504	37,25				
MF16	1,25	70	22	12,00	9,00	4	59505	39,20				
MF16	1,50	70	20	12,00	9,00	4	76443	21,44				
M16	2,00	80	32	12,00	9,00	4	76444	19,29	17461	19,29	16312	19,29
MF17	1,00	70	22	12,00	9,00	4	59506	60,00				
MF17	1,25	70	22	12,00	9,00	4	59507	60,24				

MF Nº1
bajo demanda
upon request
sur demande

Cont.

M/MF	P	L mm	I mm	d mm	a mm	Z	Nº Art. HSS	€	Nº Art. HSS	€	Nº Art. HSS	€
MF17	1,50	70	22	12,00	9,00	4	59562	28,26				
MF18	1,00	80	22	14,00	11,00	4	59508	41,39				
MF18	1,25	80	22	14,00	11,00	4	59509	58,66				
MF18	1,50	80	22	14,00	11,00	4	45039	28,33				
MF18	2,00	80	22	14,00	11,00	4	59510	44,97				
M18	2,50	95	40	14,00	11,00	4	76452	25,58	11916	25,58	66249	25,58
MF19	1,25	80	22	14,00	11,00	4	59511	86,31				
MF19	1,50	80	22	14,00	11,00	4	59512	87,82				
MF19	2,00	80	22	14,00	11,00	4	59513	104,60				
MF20	1,00	80	22	16,00	12,00	4	59514	55,13				
MF20	1,25	80	22	16,00	12,00	4	59515	86,39				
MF20	1,50	80	22	16,00	12,00	4	76476	35,50				
MF20	2,00	80	22	16,00	12,00	4	59516	46,61				
M20	2,50	95	40	16,00	12,00	4	76478	28,80	11917	28,80	17261	28,80
MF21	1,00	80	22	16,00	12,00	4	59517	112,55				
MF21	1,25	80	22	16,00	12,00	4	59518	111,62				
MF21	1,50	80	22	16,00	12,00	4	59519	89,74				
MF22	1,00	80	22	18,00	14,50	4	59521	60,97				
MF22	1,25	80	22	18,00	14,50	4	59522	87,82				
MF22	1,50	80	22	18,00	14,50	4	76484	38,72				
MF22	2,00	80	22	18,00	14,50	4	76485	62,01				
M22	2,50	100	40	18,00	14,50	4	76486	38,53	65789	38,53	15241	38,53
MF23	1,00	80	22	18,00	14,50	4	59523	112,46				
MF23	1,50	80	22	18,00	14,50	4	59524	111,52				
MF24	1,25	90	22	18,00	14,50	4	59525	113,49				
MF24	2,00	90	22	18,00	14,50	4	59526	68,75				
M24	3,00	110	50	18,00	14,50	4	76493	45,16	58475	45,16	12505	45,16
MF25	1,00	90	22	18,00	14,50	4	59527	98,50				
MF25	1,25	90	22	18,00	14,50	4	59528	159,03				
MF25	2,00	90	22	18,00	14,50	4	59561	166,29				
MF26	1,00	90	22	18,00	14,50	4	59529	86,76				
MF26	1,50	90	22	18,00	14,50	4	59530	77,78				
MF26	2,00	90	22	18,00	14,50	4	59531	95,52				
MF27	1,00	90	22	20,00	16,00	4	59532	96,65				
MF27	1,50	90	22	20,00	16,00	4	59533	86,20				
M27	3,00	110	50	20,00	16,00	4	76505	58,14	10836	58,14	66294	58,14
MF28	1,00	90	22	20,00	16,00	4	59534	160,49				
MF28	1,50	90	22	20,00	16,00	4	59535	86,41				
MF30	1,00	90	22	22,00	18,00	4	16388	120,54				
MF30	1,50	90	22	22,00	18,00	4	59536	89,63				
M30	3,50	125	50	22,00	18,00	4	76512	74,44	26582	74,44	13046	74,44
New! M32	1,50	90	22	22,00	18,00	4	25967	125,06				
MF33	1,50	100	25	25,00	20,00	4	59537	121,59				
MF33	2,00	100	25	25,00	20,00	4	59538	144,57				
M33	3,50	125	56	25,00	20,00	4	76519	93,89	66307	93,89	66308	93,89
MF34	1,50	100	25	28,00	22,00	4	59539	131,58				
MF35	1,50	100	25	28,00	22,00	4	59540	145,92				
MF36	1,50	100	25	28,00	22,00	4	59541	140,93				
MF36	3,00	125	40	28,00	22,00	4	59542	246,06				
M36	4,00	150	63	28,00	22,00	4	76525	119,80	66317	119,80	38036	119,80
MF38	1,50	100	25	28,00	22,00	4	59543	158,55				
MF38	2,00	125	40	28,00	22,00	4	59544	225,95				
MF39	1,50	110	25	32,00	24,00	4	59545	212,64				
MF39	2,00	125	40	32,00	24,00	4	59546	210,88				
MF39	3,00	125	40	28,00	22,00	4	59547	208,64				
M39	4,00	150	63	32,00	24,00	4	76531	134,04	66328	134,04	66329	134,04
MF40	1,50	110	25	32,00	24,00	4	59548	187,75				
MF40	2,00	125	40	32,00	24,00	4	59549	214,49				
MF40	3,00	125	40	32,00	24,00	4	59550	216,06				
MF42	1,50	110	25	32,00	24,00	4	14781	248,40				
MF42	2,00	125	40	32,00	24,00	4	59551	249,49				
MF42	3,00	125	40	32,00	24,00	4	59552	245,41				
M42	4,50	150	63	32,00	24,00	4	76538	167,70	66342	167,70	61071	167,70
MF45	1,50	110	25	36,00	29,00	6	16389	280,64				
MF45	2,00	125	40	36,00	29,00	6	59553	292,16				
MF45	3,00	125	40	36,00	29,00	6	59554	297,02				
M45	4,50	160	70	36,00	29,00	6	76542	193,61	32663	193,61	32664	193,61
MF48	1,50	140	40	36,00	29,00	6	16390	316,29				
MF48	2,00	140	40	36,00	29,00	6	59555	390,80				
MF48	3,00	140	40	36,00	29,00	6	59556	353,71				
M48	5,00	180	75	36,00	29,00	6	76546	233,10	66355	233,10	66356	233,10
MF50	1,50	140	40	36,00	29,00	6	59557	283,39				
MF52	1,50	140	40	40,00	32,00	6	59558	303,14				
MF52	2,00	140	40	40,00	32,00	6	59559	439,72				
MF52	3,00	140	40	40,00	32,00	6	59560	401,56				
M52	5,00	180	75	40,00	32,00	6	76551	282,96	66367	282,96	66368	282,96

MF Nº1
bajo demanda
upon request
sur demande

Ref. **3001**

MACHO ÚNICO MANO MÉTRICA

Metric Hand **Single Tap**
Taraud à main **unique** métrique

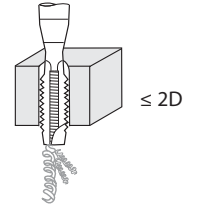
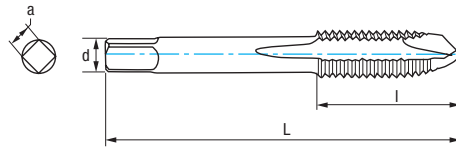

HSS

DIN 352

Tol. 6H

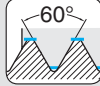

N°3 Acabado Finishing Finition

Aceros
<math><850 \text{ N/mm}^2</math>
Steel / Aciers

Fundición
Cast Iron
Fonte

Cobre
Copper
Cuivre

Aluminio
Aluminium



M	P	L mm	l mm	d mm	a mm	Z	Nº Art.	€
M3	0,50	40	11	3,50	2,70	3	25217	5,44
M4	0,70	45	13	4,00	3,00	3	25218	5,44
M5	0,80	50	16	6,00	4,90	3	25219	5,78
M6	1,00	56	19	6,00	4,90	3	25220	5,78
M8	1,25	56	22	6,00	4,90	4	25222	7,06
M10	1,50	70	24	7,00	5,50	4	25224	8,67
M12	1,75	75	29	9,00	7,00	3	25374	12,20



Línea 33 cm
3001

MACHO ÚNICO MANO MÉTRICA

Metric Hand **Single Tap**
Taraud à main **unique** métrique



∅	M3	M5	M6	M8	M10
Pcs	3	3	3	3	3

Ref. 4995 - Nº Art. 72118: **98,15 €**



Ref. **3023**

MACHO MANO PERFIL ROSCA COMPLETA

Whole Thread Profile Hand Tap

Taraud à main profil filetage complet

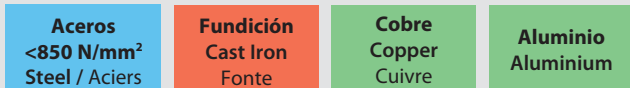
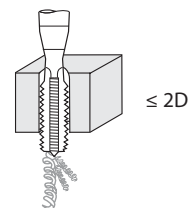
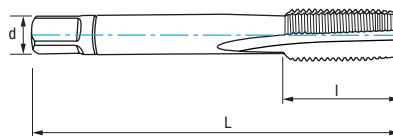

Macho único que **finaliza la rosca completa** en agujeros pasantes. Espesor material <1,5 mm. Viruta media/larga.

Single tap for **whole thread finishing** in through holes. Material thickness <1,5 mm. Medium/long chip removal.

Guidage et filetage complet sur trous débouchants. Épaisseur matériel <1,5 mm. Copeaux moyens/longs.



M	P	L mm	l mm	d mm	a mm	Z	Nº Art.	€
M3	0,50	40	11	3,50	2,70	3	46263	8,25
M4	0,70	45	13	4,50	3,40	3	46264	8,25
M5	0,80	50	16	6,00	4,90	3	46265	8,75
M6	1,00	50	19	6,00	4,90	3	46266	8,75
M8	1,25	56	22	6,00	4,90	4	46267	10,68
M10	1,50	70	24	7,00	5,50	4	46268	13,12
M12	1,75	75	29	9,00	7,00	4	46269	18,48
M16	2,00	80	32	12,00	9,00	4	46270	28,94
M20	2,50	95	40	16,00	12,00	4	46271	43,20

Línea 33 cm
3023

MACHO MANO PERFIL ROSCA COMPLETA

Whole Thread Profile Hand Tap

Taraud à main profil filetage complet



ø	M3	M4	M5	M6	M8	M10
Pcs	5	5	5	5	5	5

Ref. 4995 - Nº Art. 72121: **288,97 €**



Ref. **3040**

JUEGO MACHOS ÚNICOS MANO MÉTRICA NORMA ISO

ISO Standard Metric Hand Single Tap Set

Jeu de tarauds *uniques* à main métrique *norme ISO*





Nº3  **C 2-3h**

Nº3  **B 3,5-5h**

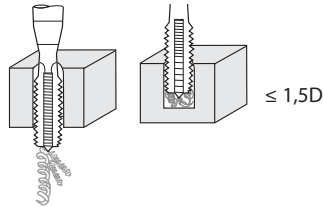
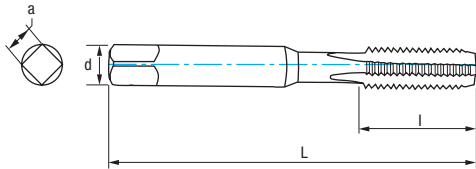
Nº3  **A 8h**



HSS	ISO 529	Tol. 6H	A 8h	B 3,5-5h	C 2-3h		α $10^\circ \pm 2$		Nº3 Acabado Finishing Finition
Aceros <math><850 \text{ N/mm}^2</math> Steel / Acciai	Fundición Cast Iron Ghisa	Cobre Copper Rame	Aluminio Aluminium Alluminio						



M	P	L mm	l mm	d mm	a mm	Z	Nº Art.	€
M2	0,40	41	8	2,50	2,00	3	83527	28,32
M3	0,50	48	11	3,15	2,50	3	68870	16,03
M4	0,70	53	13	4,00	3,15	3	68871	16,03
M5	0,80	58	16	5,00	4,00	3	68872	16,99
M6	1,00	66	19	6,30	5,00	3	68873	16,99
M8	1,25	72	22	8,00	6,30	4	68874	20,77
M10	1,50	80	24	10,00	8,00	4	68875	25,50
M12	1,75	89	29	9,00	7,10	4	68876	35,85
M14	2,00	95	30	11,20	9,00	4	68877	39,65
M16	2,00	102	32	12,50	10,00	4	68878	56,26



Ref. **3032**

JUEGO MACHOS MANO BSW (WHITWORTH)

BSW (Whitworth) Hand Tap Set

Jeu de tarauds à main BSW (Whitworth)

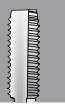
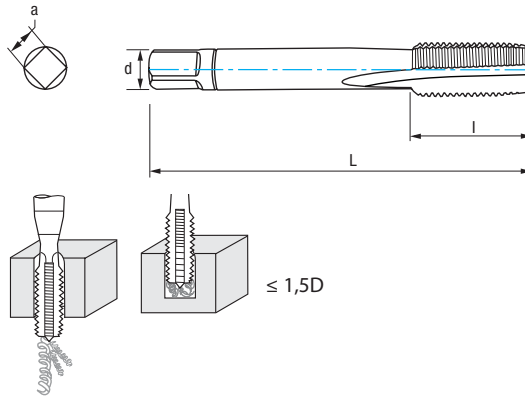

HSS	DIN 352	C 2-3h	α $10^\circ \pm 2$	55°	Rosca Whitworth cilíndrica Straight Whitworth Thread Filetage Whitworth cylindrique
------------	---------	-----------	------------------------------	-----	---

Aceros <850 N/mm ² Steel / Aciers	Fundición Cast Iron Fonte	Cobre Copper Cuivre	Aluminio Aluminium
---	--	----------------------------------	------------------------------



W	Hilos Threads Filets	L mm	l mm	d mm	a mm	Z	Nº Art.	€
W3/32	48,00	36	10	2,80	2,10	3	62663	31,28
W1/8	40,00	40	12	3,50	2,70	3	62642	25,45
W5/32	32,00	45	14	4,50	3,40	3	62675	25,45
W3/16	24,00	50	18	6,00	4,90	3	62660	25,45
W7/32	24,00	50	18	6,00	4,90	3	62684	38,48
W1/4	20,00	50	19	6,00	4,90	3	62633	28,96
W5/16	18,00	56	22	6,00	4,90	4	62669	34,47
W3/8	16,00	70	24	7,00	5,50	4	62654	38,14
W7/16	14,00	70	24	8,00	6,20	4	62681	49,96
W1/2	12,00	75	29	9,00	7,00	4	62630	55,19
W9/16	12,00	80	30	11,00	9,00	4	62687	74,57
W5/8	11,00	80	32	12,00	9,00	4	62666	86,26
W3/4	10,00	95	40	14,00	11,00	4	62645	122,77
W7/8	9,00	100	40	18,00	14,50	4	62678	152,47
W1"	8,00	110	50	18,00	14,50	4	62693	188,26
W1"1/8	7,00	132	56	22,00	18,00	4	62702	279,09
W1"1/4	7,00	132	56	22,00	18,00	4	62699	330,09
W1"3/8	6,00	150	63	28,00	22,00	4	42713	410,54
W1"1/2	6,00	150	63	32,00	24,00	4	62696	494,26
W1"5/8	5,00	160	70	32,00	24,00	4	59880	636,54
W1"3/4	5,00	160	70	36,00	29,00	6	59881	783,45
W1"7/8	4,50	190	80	36,00	29,00	6	59882	1.011,88
W2"	4,50	190	80	40,00	32,00	6	59883	1.062,27



Ref. **3012**

MACHO ÚNICO MANO BSW (WHITWORTH)

BSW (Whitworth) Hand Tap
Taraud à main BSW (Whitworth)

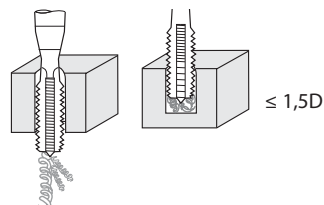
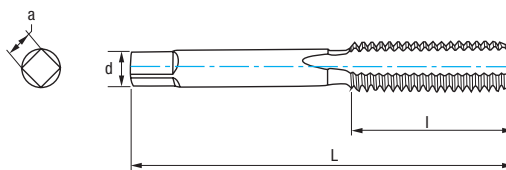

HSS

DIN 352



α
 $10^\circ \pm 2$

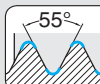

Rosca Whitworth cilíndrica
Straight Whitworth Thread
Filetage Whitworth cylindrique

Nº3 Acabado
Finishing
Finition

Aceros
<math><850 \text{ N/mm}^2</math>
Steel / Aciers

Fundición
Cast Iron
Fonte

Cobre
Copper
Cuivre

Aluminio
Aluminium

W	Hilos Threads	Filets	L mm	l mm	d mm	a mm	Z	Nº Art.	€
W3/32	48,00		40	9	2,80	2,10	3	75404	10,43
W1/8	40,00		40	14	3,50	2,70	3	75401	8,50
W5/32	32,00		45	17	4,50	3,40	3	75069	8,50
W3/16	24,00		50	19	6,00	4,90	3	74825	8,50
W7/32	24,00		50	19	6,00	4,90	3	75409	12,84
W1/4	20,00		50	20	6,00	4,90	3	75400	9,64
W5/16	18,00		56	20	6,00	4,90	4	75406	11,51
W3/8	16,00		63	22	7,00	5,50	4	75403	12,71
W7/16	14,00		70	22	8,00	6,20	4	75408	16,65
W1/2	12,00		75	25	9,00	7,00	4	75399	18,39
W9/16	12,00		80	26	11,00	9,00	4	75448	24,83
W5/8	11,00		80	27	12,00	9,00	4	75405	28,75
W3/4	10,00		95	32	14,00	11,00	4	75402	40,93
W7/8	9,00		100	32	18,00	14,50	4	75407	50,83
W1"	8,00		110	36	18,00	14,50	4	75410	62,76
W1" 1/8	7,00		125	40	22,00	18,00	4	76255	93,03
W1" 1/4	7,00		125	40	22,00	18,00	4	76259	112,03
W1" 3/8	6,00		150	50	28,00	22,00	4	76264	139,97
W1" 1/2	6,00		150	50	32,00	24,00	4	76269	168,54
W1" 5/8	5,00		150	56	32,00	24,00	4	76274	219,91
W1" 3/4	5,00		160	58	36,00	29,00	4	76280	270,54
W1" 7/8	4,50		180	65	36,00	29,00	4	76286	349,44
W2"	4,50		180	65	40,00	32,00	4	76291	366,86



Ref. **3026**

JUEGO MACHOS MANO BSP (GAS)

BSP (Gas) Hand Tap Set
Jeu tarauds à main BSP (Gaz)

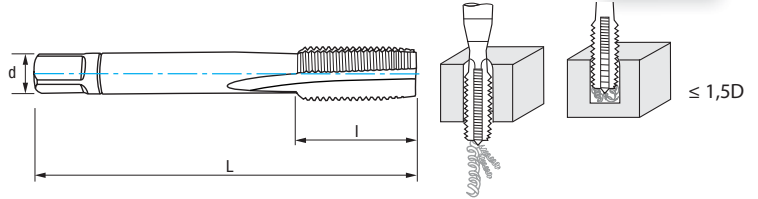

HSS
DIN 5157
ISO 2284
B 4-5h
C 2-3h
Hand icon
 α 10° ± 2
55°
Rosca Whitworth Paralela (BSPP)
Whitworth Parallel Thread (BSPP)
Filetage Whitworth Parallèle (BSPP)

Aceros <850 N/mm² Steel / Aciers
Fundición Cast Iron Fonte
Cobre Copper Cuivre
Aluminio Aluminium



DIN 5157
N°1 Desbaste Roughing Ébauche
N°3 Acabado Finishing Finition

N°1 **B 4-5h**

N°3 **C 2-3h**

G	Hilos Threads Filets	L mm	l mm	d mm	a mm	Z	N° Art.	€
G1/8	28	63	20	7,00	5,50	3	62510	26,10
G1/4	19	70	22	11,00	9,00	4	62504	36,72
G3/8	19	70	22	12,00	9,00	4	62516	45,12
G1/2	14	80	22	16,00	12,00	4	62498	64,74
G5/8	14	80	22	18,00	14,50	4	62522	82,80
G3/4	14	90	22	20,00	16,00	4	62513	101,08
G7/8	14	90	22	22,00	18,00	4	62525	134,82
G1"	11	100	25	25,00	20,00	4	62528	160,17
G1" 1/8	11	125	40	28,00	22,00	4	76195	250,86
G1" 1/4	11	125	40	32,00	24,00	4	76203	373,38
G1" 3/8	11	125	40	36,00	29,00	4	76211	371,31
G1" 1/2	11	140	40	36,00	29,00	6	74823	413,15
G1" 3/4	11	140	40	40,00	32,00	6	76225	686,86
G2"	11	160	40	45,00	35,00	8	76231	763,73

New!

ISO 2284
N°3 Acabado Finishing Finition

N°3 **B 4-5h**

N°3 **C 2-3h**

G	Hilos Threads Filets	L mm	l mm	d mm	a mm	Z	N° Art.	€
G1/8	28	59	15	8,00	6,30	4	26780	22,97
G1/4	19	67	19	10,00	8,00	4	26789	32,31
G3/8	19	75	21	12,50	10,00	4	26814	40,59
G1/2	14	87	26	16,00	12,50	4	26830	56,97
G5/8	14	91	26	18,00	14,00	4	26845	72,86
G3/4	14	96	28	20,00	16,00	4	26852	88,95
G7/8	14	102	29	22,40	18,00	6	26857	118,64
G1"	11	109	33	25,00	20,00	6	26860	140,95
G1" 1/8	11	116	34	28,00	22,40	6	26891	220,76
G1" 1/4	11	119	36	31,50	25,00	6	26950	240,57
G1" 3/8	11	120	36	31,50	25,00	6	26954	326,75
G1" 1/2	11	125	37	35,50	28,00	6	26973	363,57
G1" 3/4	11	132	39	35,50	28,00	6	26988	604,44
G2"	11	140	41	40,00	31,50	6	27002	672,08

Ref. **3016**

MACHO ÚNICO MANO BSP (GAS)

BSP (Gas) Hand Tap
Taraud à main BSP (Gaz)

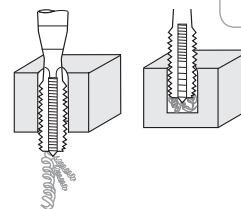
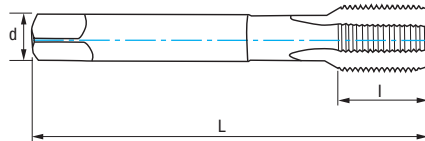
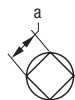

≤ 1,5D

HSS	DIN 5157	ISO 2284		α 10° ± 2	 Rosca Whitworth Paralela (BSPP) Whitworth Parallel Thread (BSPP) Filetage Whitworth Parallèle (BSPP)	Nº3 Acabado Finishing Finition	
Aceros <850 N/mm ² Steel / Aciers	Fundición Cast Iron Fonte	Cobre Copper Cuivre	Aluminio Aluminium				

Nº3



DIN 5157



G	Entrada Chamfer Entrée	Hilos Threads Filets	L mm	l mm	d mm	a mm	Z	Nº Art.	€
G1/8	C	28	63	20	7,00	5,50	3	75461	13,08
G1/4		19	70	22	11,00	9,00	4	75460	18,37
G3/8		19	70	22	12,00	9,00	4	75462	23,08
G1/2		14	80	22	16,00	12,00	4	75459	32,35
G5/8		14	80	22	18,00	14,50	4	75463	41,40
G3/4		14	90	22	20,00	16,00	4	75106	50,52
G7/8		14	90	22	22,00	18,00	4	76246	67,41
G1"		11	100	25	25,00	20,00	4	75464	80,08
G1" 1/8		11	125	40	28,00	22,00	4	76196	125,43
G1" 1/4		11	125	40	32,00	24,00	4	76204	136,69
G1" 3/8		11	140	40	36,00	29,00	4	76212	185,66
G1" 1/2		11	140	40	36,00	29,00	6	76218	206,58
G1" 3/4		11	140	40	40,00	32,00	6	76226	343,43
G2"		11	160	40	45,00	35,00	8	76232	381,87

New!

ISO 2284



G	Entrada Chamfer Entrée	Hilos Threads Filets	L mm	l mm	d mm	a mm	Z	Nº Art.	€
G1/8	B	28	59	15	8,00	6,30	4	26759	11,48
	C							26779	11,48
G1/4	B	19	67	19	10,00	8,00	4	26781	16,16
	C							26783	16,16
G3/8	B	19	75	21	12,50	10,00	4	26790	20,29
	C							26791	20,29
G1/2	B	14	87	26	16,00	12,50	4	26823	28,49
	C							26827	28,49
G5/8	B	14	91	26	18,00	14,00	4	26832	36,43
	C							26843	36,43
G3/4	B	14	96	28	20,00	16,00	4	26849	44,48
	C							26850	44,48
G7/8	B	11	102	29	22,40	18,00	6	26853	59,32
	C							26855	59,32
G1"	B	11	109	33	25,00	20,00	6	26858	70,47
	C							26859	70,47
G1" 1/8	B	11	116	34	28,00	22,40	6	26862	110,38
	C							26873	110,38
G1" 1/4	B	11	119	36	31,50	25,00	6	26941	120,29
	C							26948	120,29
G1" 3/8	B	11	120	36	31,50	25,00	6	26951	163,38
	C							26953	163,38
G1" 1/2	B	11	125	37	35,50	28,00	6	26956	181,79
	C							26971	181,79
G1" 3/4	B	11	132	39	35,50	28,00	6	26974	302,22
	C							26976	302,22
G2"	B	11	140	41	40,00	31,50	8	26991	336,04
	C							26997	336,04

Nº3



Ref. **3100**

MACHO RECTO MÁQUINA MÉTRICA MANGO REFORZADO

Reinforced Shank Metric Machine Straight Tap
Taraud droit machine métrique queue renforcée

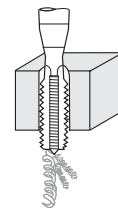
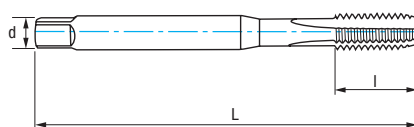

$\le 2D$

HSSE
5% Co

DIN
371

Reforzado
Reinforced
Renforcée

B
3,5-5h



Tol.
6H

α
 $10^\circ \pm 2$

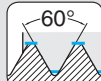

Aceros
<math><850 \text{ N/mm}^2</math>
Steel / Aciers

Cobre
Copper
Cuivre

Aluminio
Aluminium



M	P	L mm	l mm	d mm	a mm	Z	Nº Art.	€
M2	0,40	45	9	2,80	2,10	3	62771	16,31
M2,5	0,45	50	9	2,80	2,10	3	76724	16,31
M2,6	0,45	50	9	2,80	2,10	3	76725	16,31
M3	0,50	56	11	3,50	2,70	3	62774	9,25
M3,5	0,60	56	13	4,00	3,00	3	62777	14,66
M4	0,70	63	13	4,50	3,40	3	62780	9,78
M4,5	0,75	70	16	6,00	4,90	3	76728	22,20
M5	0,80	70	16	6,00	4,90	3	62783	9,78
M6	1,00	80	19	6,00	4,90	3	62789	10,75
M7	1,00	80	19	7,00	5,50	3	76733	17,00
M8	1,25	90	22	8,00	6,20	3	62795	12,02
M9	1,25	90	18	9,00	7,00	3	62798	20,08
M10	1,50	100	24	10,00	8,00	3	62807	14,80



Expo 25 Pcs

Cont. Ø	Nº Art.	€
Machos / Taps / Tarauds DIN 371: M4-M5-M6-M8- M10 (5 pcs x M)	38998	285,66

Set Ref. 3100

7 Pcs



Cont. Ø	Nº Art.	€
Machos / Taps / Tarauds DIN 371: M3-M4-M5- M6-M8-M10 + DIN 376: M12	43348	85,12

Set Ref. 3100 + 1010 HSS

14 Pcs



Cont. Ø	Nº Art.	€
Machos / Taps / Tarauds DIN 371: M3-M4-M5- M6-M8-M10 + DIN 376: M12	43354	98,03
Brocas / Drill Bits / Forets HSS: 2,5-3,3-4,2-5,0-6,8- 8,5-10,2		

Set Ref. 3100 + 1016 HSSE

14 Pcs



Cont. Ø	Nº Art.	€
Machos / Taps / Tarauds DIN 371: M3-M4-M5- M6-M8-M10 + DIN 376: M12	21801	108,93
Brocas / Drill Bits / Forets HSSE: 2,5-3,3-4,2-5,0-6,8- 8,5-10,2		

Set Ref. 3100 + 1015 Zirkonio

14 Pcs



Cont. Ø	Nº Art.	€
Machos / Taps / Tarauds DIN 371: M3-M4-M5- M6-M8-M10 + DIN 376: M12	56424	109,55
Brocas / Drill Bits / Forets HSS: 2,5-3,3-4,2-5,0-6,8- 8,5-10,2		

New!

Ref. **3200**

MACHO RECTO MÁQUINA MÉTRICA/ MÉTRICA FINA

Metric / Metric Fine Machine Straight Tap

Taroud droit machine métrique / métrique pas fin

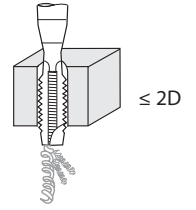
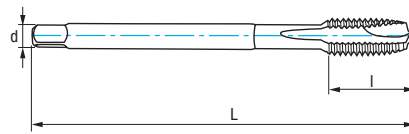

HSSE 5% Co	M DIN 376	MF DIN 374	B 3,5-5h	GUN	Tol. 6H	α $10^\circ \pm 2$	60°
----------------------	-----------------	------------------	-------------	-----	------------	------------------------------	------------

Aceros <850 N/mm ² Steel / Aciers	Cobre Copper Cuivre	Aluminio Aluminium
---	----------------------------------	------------------------------



M/MF	P	L mm	l mm	d mm	a mm	Z	Nº Art.	€
M3	0,50	56	11	2,20			70090	9,88
M4	0,70	63	13	2,80	2,10	3	70092	10,01
M5	0,80	70	16	3,50	2,70	3	70093	10,01
M6	1,00	80	19	4,50	3,40	3	70095	10,99
M7	1,00	80	19	5,50	4,30	3	70224	17,46
MF8	0,75	80	19	6,00	4,90	3	70267	25,46
MF8	1,00	90	22	6,00	4,90	3	70248	20,64
M8	1,25	90	22	6,00	4,90	3	70096	12,34
MF10	1,00	90	20	7,00	5,50	3	70249	23,00
MF10	1,25	100	24	7,00	5,50	3	70251	27,42
M10	1,50	100	24	7,00	5,40	3	70098	15,20
M11	1,50	100	24	8,00	6,20	3	70225	29,33
MF12	1,00	100	22	9,00	7,00	3	70252	30,29
MF12	1,25	100	22	9,00	7,00	3	70254	30,59
MF12	1,50	100	22	9,00	7,00	3	70255	27,33
M12	1,75	110	29	9,00	7,00	3	70183	18,73
MF14	1,00	100	22	11,00	9,00	3	70281	46,44
MF14	1,25	100	22	11,00	9,00	3	70257	40,70
MF14	1,50	100	22	11,00	9,00	3	70258	32,35
M14	2,00	110	30	11,00	9,00	3	70185	30,04
MF15	1,50	100	22	12,00	9,00	3	70282	51,56
MF16	1,50	100	22	12,00	9,00	3	70260	40,44
M16	2,00	110	32	12,00	9,00	3	70186	35,36
MF18	1,00	110	25	14,00	11,00	3	70284	64,70
MF18	1,50	110	25	14,00	11,00	3	70261	50,59
MF18	2,00	125	34	14,00	11,00	3	70285	65,29
M18	2,50	125	34	14,00	11,00	3	75215	50,07
MF20	1,00	125	25	16,00	12,00	3	70287	85,39
MF20	1,50	125	25	16,00	12,00	3	70263	57,20
MF20	2,00	140	34	16,00	12,00	3	70288	75,02
M20	2,50	140	34	16,00	12,00	3	70189	54,14
MF22	1,50	125	25	18,00	14,50	3	75216	68,92
MF22	2,00	140	34	18,00	14,50	3	70290	109,22

M/MF	P	L mm	l mm	d mm	a mm	Z	Nº Art.	€
M22	2,50	140	34	18,00	14,50	3	70212	65,49
MF24	1,50	140	28	18,00	14,50	4	70264	84,73
MF24	2,00	140	28	18,00	14,50	4	70291	107,10
M24	3,00	160	38	18,00	14,50	4	70213	77,86
MF26	1,50	140	28	18,00	14,50	4	70293	108,88
MF27	2,00	140	28	20,00	16,00	4	70294	148,51
M27	3,00	160	38	20,00	16,00	4	70215	97,57
MF28	1,50	140	28	20,00	16,00	4	70296	124,53
MF30	1,50	150	28	22,00	18,00	4	70266	130,06
M30	3,50	180	45	22,00	18,00	4	70216	125,38
MF32	1,50	150	28	22,00	18,00	4	70297	155,66
MF33	1,50	160	30	25,00	20,00	4	70299	177,96
MF33	2,00	160	30	25,00	20,00	4	70300	257,13
M33	3,50	180	50	25,00	20,00	4	70218	157,70
MF35	1,50	170	30	28,00	22,00	4	70302	206,16
MF36	1,50	170	30	28,00	22,00	4	81355	228,53
MF36	2,00	170	30	28,00	22,00	4	81356	228,73
MF36	3,00	200	42	28,00	22,00	4	81357	262,40
M36	4,00	200	56	28,00	22,00	4	70219	192,66
MF39	1,50	170	30	32,00	24,00	4	81358	258,28
MF39	2,00	170	30	32,00	24,00	4	81359	229,17
MF39	3,00	200	42	32,00	24,00	4	81360	220,81
M39	4,00	200	50	32,00	24,00	4	81361	215,88
MF42	1,50	170	30	32,00	24,00	4	81362	242,18
MF42	2,00	170	30	32,00	24,00	4	81363	237,41
MF42	3,00	200	50	32,00	24,00	4	81364	367,86
M42	4,50	200	56	32,00	24,00	4	14886	277,53
MF45	1,50	180	32	36,00	29,00	6	70303	361,21
M45	4,50	220	56	36,00	29,00	6	81365	350,54
M48	5,00	250	63	36,00	29,00	6	81366	503,34
M52	5,00	250	63	40,00	32,00	6	81367	566,25
M56	5,50	250	65	40,00	32,00	6	81368	620,17
M60	5,50	280	75	45,00	35,00	6	81369	659,12



Expo 25 Pcs

Cont.	Nº Art.	€
Machos / Taps / Tarauds DIN 376: M4-M5-M6-M8- M10 (5 pcs x M)	39000	292,69

Ref. **3150**

MACHO HELICOIDAL MÁQUINA MÉTRICA MANGO REFORZADO

Reinforced Shank Metric Machine Spiral Tap

Taraud helicoidal machine métrique queue renforcée

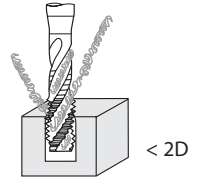
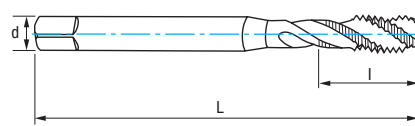

HSSE 5% Co	DIN 371	Reforzado Reinforced Renforcée	C 2-3h	35°	α 10° ± 2	60°
----------------------	------------	---	------------------	------------	---------------------	------------

Aceros <850 N/mm ² Steel / Aciers	Cobre Copper Cuivre	Aluminio Aluminium
---	----------------------------------	------------------------------



M	P	L mm	l mm	d mm	a mm	Z	Nº Art.	€
M3	0,50	56	5	3,50	2,70	3	63050	12,20
M3,5	0,60	56	6	4,00	3,00	3	63053	17,94
M4	0,70	63	7	4,50	3,40	3	63056	12,20
M5	0,80	70	8	6,00	4,90	3	63059	11,64
M6	1,00	80	10	6,00	4,90	3	63062	12,78
M7	1,00	80	10	7,00	5,50	3	63065	19,92
M8	1,25	90	13	8,00	6,20	3	63071	14,61
M9	1,25	90	13	9,00	7,00	3	67882	24,90
M10	1,50	100	15	10,00	8,00	3	63083	17,32



Expo 25 Pcs

Cont. Ø	Nº Art.	€
Machos / Taps / Tarauds DIN 371: M4-M5-M6-M8-M10 (5 pcs x M)	38999	342,74

Set Ref. 3150
7 Pcs



Cont. Ø	Nº Art.	€
Machos / Taps / Tarauds DIN 371: M3-M4-M5-M6-M8-M10 + DIN 376: M12	43353	102,94

Set Ref. 3150 + 1010 HSS
14 Pcs



Cont. Ø	Nº Art.	€
Machos / Taps / Tarauds DIN 371: M3-M4-M5-M6-M8-M10 + DIN 376: M12 Brocas / Drill Bits / Forets HSS: 2,5-3,3-4,2-5,0-6,8-8,5-10,2	43359	115,85

Set Ref. 3150 + 1016 HSSE
14 Pcs



Cont. Ø	Nº Art.	€
Machos / Taps / Tarauds DIN 371: M3-M4-M5-M6-M8-M10 + DIN 376: M12 Brocas / Drill Bits / Forets HSSE: 2,5-3,3-4,2-5,0-6,8-8,5-10,2	21802	126,74

Set Ref. 3150 + 1015 Zirkonio **New!**
14 Pcs



Cont. Ø	Nº Art.	€
Machos / Taps / Tarauds DIN 371: M3-M4-M5-M6-M8-M10 + DIN 376: M12 Brocas / Drill Bits / Forets HSSE: 2,5-3,3-4,2-5,0-6,8-8,5-10,2	56428	127,39

Ref. **3250**

MACHO HELICOIDAL MÁQUINA MÉTRICA / MÉTRICA FINA

Metric / Metric Fine Machine Spiral Tap

Taraud hélicoïdal machine métrique / métrique pas fin

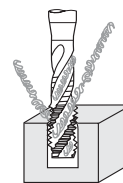
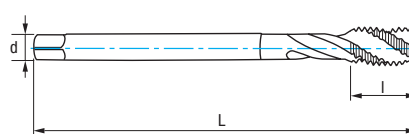

< 2D

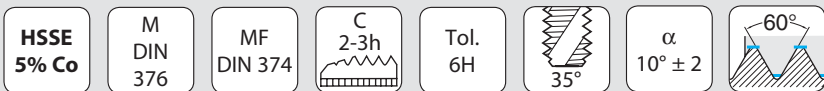

Aceros
<850 N/mm²
Steel / Aciers

Cobre
Copper
Cuivre

Aluminio
Aluminium



M/MF	P	L mm	l mm	d mm	a mm	Z	Nº Art.	€
M3	0,50	56	5	2,20		3	70063	11,89
M4	0,70	63	7	2,80	2,10	3	70065	11,80
M5	0,80	70	8	3,50	2,70	3	70066	11,30
M6	1,00	80	10	4,50	3,40	3	70068	12,38
MF8	1,00	90	13	6,00	4,90	3	70228	24,48
M8	1,25	90	13	6,00	4,90	3	70069	14,52
MF10	1,00	90	12	7,00	5,50	3	70230	28,85
MF10	1,25	100	15	7,00	5,50	3	70231	31,41
M10	1,50	100	15	7,00	5,50	3	70071	17,26
MF12	1,00	100	14	9,00	7,00	3	70233	35,84
MF12	1,25	100	14	9,00	7,00	3	70234	34,30
MF12	1,50	100	14	9,00	7,00	3	70236	33,00
M12	1,75	110	18	9,00	7,00	3	70161	22,20
MF14	1,25	100	16	11,00	9,00	3	70237	50,67
MF14	1,50	100	16	11,00	9,00	3	70239	40,57
M14	2,00	110	20	11,00	9,00	3	70162	34,84
MF16	1,50	100	16	12,00	9,00	3	70240	49,87
M16	2,00	110	20	12,00	9,00	4	70164	42,09
MF18	1,50	110	20	14,00	11,00	4	70242	60,24
M18	2,50	125	25	14,00	11,00	4	75057	56,68
MF20	1,50	125	20	16,00	12,00	4	70243	68,80
M20	2,50	140	25	16,00	12,00	4	70167	60,34
MF22	1,50	125	20	18,00	14,50	4	75192	90,05
M22	2,50	140	25	18,00	14,50	4	70206	74,44
MF24	1,50	140	22	18,00	14,50	4	70245	100,86
MF24	2,00	140	28	18,00	14,50	4	24326	105,87
M24	3,00	160	30	18,00	14,50	4	70207	89,10
New! MF27	2,00	140	28	20,00	16,00	4	71566	166,97
M27	3,00	160	30	20,00	16,00	4	70209	111,31
MF30	1,50	150	28	22,00	18,00	4	70246	155,09
M30	3,50	180	35	22,00	18,00	4	70210	142,57



Expo 25 Pcs

Cont. Ø	Nº Art.	€
Machos / Taps / Tarauds DIN 376: M4-M5-M6-M8- M10 (5 pcs x M)	39001	336,27

Ref. **3119**

MACHO RECTO MÁQUINA MÉTRICA NORMA ISO 529

ISO 529 Norm Standard Metric Machine Straight Tap

Taraud droit machine métrique norme ISO 529

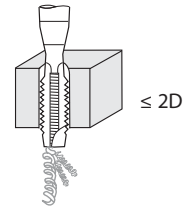
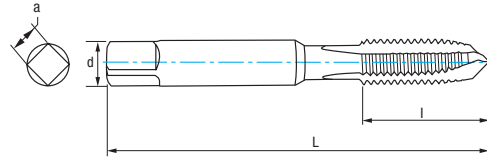

HSSE 5% Co
ISO 529
B 4-5h
Tol. 6H
GUN
 α $10^\circ \pm 2$
60°
Vaporizado Vaporized Vaporisée

Aceros <math><850\text{ N/mm}^2</math> Steel / Aciers
INOX Stainless Steel Acier INOX
Cobre Copper Cuivre
Aluminio Aluminium



	M	P	L mm	l mm	d mm	a mm	Z	Nº Art.	€
(New!)	M2	0,40	41	8	2,50	2,00	2	77478	14,59
(New!)	M2,5	0,45	44	9,5	2,80	2,24	2	77479	14,59
	M3	0,50	48	11	3,15	2,50	3	69558	8,26
(New!)	M3,5	0,60	53	13	4,00	3,15	3	69562	13,09
	M4	0,70	53	13	4,00	3,15	3	69567	8,26
(New!)	M4,5	0,75	58	16	5,00	4,00	3	69570	13,09
	M5	0,80	58	16	5,00	4,00	3	69575	8,26
	M6	1,00	66	19	6,30	5,00	3	69582	8,26
(New!)	M7	1,00	66	19	6,30	5,00	3	69583	15,58
	M8	1,25	72	22	8,00	6,30	3	69586	12,14
	M10	1,50	80	24	10,00	8,00	3	69588	14,57
	M12	1,75	89	29	9,00	7,10	3	69607	18,71
	M14	2,00	95	30	11,20	9,00	3	69608	24,29
	M16	2,00	102	32	12,50	10,00	3	69610	33,96
	M18	2,50	112	37	14,00	11,20	3	69611	44,53
	M20	2,50	112	37	14,00	11,20	3	69613	59,95
	M22	2,50	118	38	16,00	12,50	3	69614	72,59
	M24	3,00	130	45	18,00	14,00	3	69616	95,69
	M27	3,00	135	45	20,00	16,00	3	69617	117,86
	M30	3,50	138	48	20,00	16,00	3	69619	151,88

Línea 33 cm
3119

MACHO RECTO MÁQUINA MÉTRICA NORMA ISO 529

ISO 529 Norm Standard Metric Machine Straight Tap

Taraud droit machine métrique norme ISO 529



α	M3	M5	M6	M8	M10
Pcs	3	3	3	3	3

Ref. 4995 - Nº Art. 70993: 149,46 €



Ref. **3113**

MACHO HELICOIDAL MÁQUINA MÉTRICA NORMA ISO 529

ISO 529 Standard Metric Machine Spiral Tap

Taraud helicoidal machine métrique norme ISO 529

New!

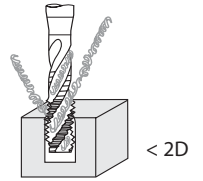
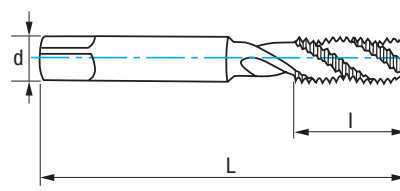

HSSE
5% Co

ISO
529



Tol.
6H



α
12-14°

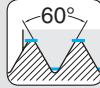

Vaporizado
Vaporized
Vaporisée

Aceros
<850 N/mm²
Steel / Aciers

Cobre
Copper
Cuivre

Aluminio
Aluminium



M	P	L mm	l mm	d mm	a mm	Z	Nº Art.	€
M2	0,40	41	8	2,50	2,00	2	48989	17,13
M2,5	0,45	44	9,5	2,80	2,24	2	48992	17,13
M3	0,50	48	6	3,15	2,50	3	49004	9,72
M3,5	0,60	50	6	3,55	2,80	3	49016	15,40
M4	0,70	53	7	4,00	3,15	3	49019	9,72
M5	0,80	58	8	5,00	4,00	3	49022	9,72
M6	1,00	66	10	6,30	5,00	3	49025	9,72
M7	1,00	66	13	7,10	5,60	3	49028	18,34
M8	1,25	72	12	8,00	6,30	3	49031	12,97
M10	1,50	80	15	10,00	8,00	3	49034	16,50
M12	1,75	89	16	9,00	7,10	3	49187	21,23
M14	2,00	95	18	11,20	9,00	3	49190	27,01
M16	2,00	102	18	12,50	10,00	4	49193	37,73
M18	2,50	112	29	14,00	11,20	4	49196	49,52
M20	2,50	112	29	14,00	11,20	4	49199	66,61
M22	2,50	118	29	16,00	12,50	4	49202	80,67
M24	3,00	130	35	18,00	14,00	4	49205	106,32
M27	3,00	135	45	20,00	16,00	3	77480	133,23
M30	3,50	138	48	20,00	16,00	3	77481	171,04



Ref. **3109**

MACHO RECTO MÁQUINA MÉTRICA NORMA ISO 529

ISO 529 Norm Standard Metric Machine Straight Tap

Taroud droit machine métrique norme ISO 529

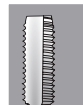
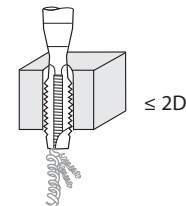
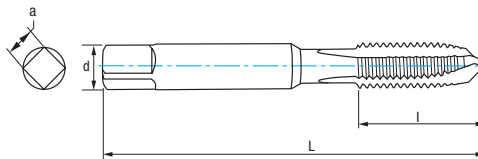

HSS

ISO
529

B
4-5h

Tol.
6H

GUN

α
 $10^\circ \pm 2$

60°

Aceros
<850 N/mm²
Steel / Aciers

Cobre
Copper
Cuivre

Aluminio
Aluminium



(New!)

M	P	L mm	l mm	d mm	a mm	Z	Nº Art.	€	Nº Art. TIN	€
M3	0,50	48	11	3,15	2,50	3	38180	7,18	31717	9,93
M3,5	0,60	53	13	4,00	3,15	3	38181	11,37	70208	14,45
M4	0,70	53	13	4,00	3,15	3	38182	7,18	31718	10,16
M4,5	0,75	58	16	5,00	4,00	3	38183	11,37	70229	14,45
M5	0,80	58	16	5,00	4,00	3	38373	7,18	31719	10,16
M6	1,00	66	19	6,30	5,00	3	38185	7,18	31720	10,16
M7	1,00	66	19	6,30	5,00	3	38186	11,63	70235	15,42
M8	1,25	72	22	8,00	6,30	3	38187	9,59	31721	13,38
M10	1,50	80	24	10,00	8,00	3	38188	12,20	31722	18,11
M12	1,75	89	29	9,00	7,10	3	38189	15,67	31729	22,12
M14	2,00	95	30	11,20	9,00	3	38190	18,74	31730	26,44
M16	2,00	102	32	12,50	10,00	3	38191	23,27	31732	32,64
M18	2,50	112	37	14,00	11,20	3	38192	35,03	31734	44,94
M20	2,50	112	37	14,00	11,20	3	38193	39,16	31736	51,10
M22	2,50	118	38	16,00	12,50	3	38194	45,27	31737	59,08
M24	3,00	130	45	18,00	14,00	3	38195	51,15	31746	66,01
M27	3,00	135	45	20,00	16,00	3	38196	62,99	31747	104,19
M30	3,50	138	48	20,00	16,00	3	38197	93,59	31748	134,79
(New!) M33	3,50	151	51	22,40	18,00	4	31585	117,27	31749	158,47
(New!) M36	4,00	162	57	25,00	20,00	4	31588	143,27	31751	191,75
(New!) M39	4,00	170	60	28,00	22,40	4	31605	160,54	31752	209,02
(New!) M42	4,50	170	60	28,00	22,40	4	31607	206,39	31753	264,07
(New!) M45	4,50	187	67	31,50	25,00	4	31609	260,69	31754	318,37
(New!) M48	5,00	187	67	31,50	25,00	4	31616	374,32	31755	435,87



Línea 33 cm 3109 -1-

26
cm



MACHO RECTO MÁQUINA MÉTRICA NORMA ISO 529

ISO 529 Norm Standard Metric Machine Straight Tap

Taroud droit machine métrique norme ISO 529

∅	M3	M5	M6	M8	M10
Pcs	3	3	3	3	3

Ref. 4995 - N° Art. 71560: 129,93 €

Línea 33 cm 3109 -2-

26
cm



MACHO RECTO MÁQUINA MÉTRICA NORMA ISO 529

ISO 529 Norm Standard Metric Machine Straight Tap

Taroud droit machine métrique norme ISO 529

∅	M12	M14	M16	M18	M20
Pcs	3	3	3	3	3

Ref. 4995 - N° Art. 71563: 395,59 €

Ref. **3157**

MACHO HELICOIDAL MÁQUINA MÉTRICA NORMA ISO 529

ISO 529 Norm Standard Metric Machine Spiral Tap

Taraud hélicoïdal machine métrique norme ISO 529

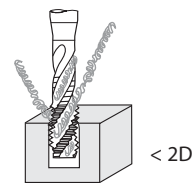
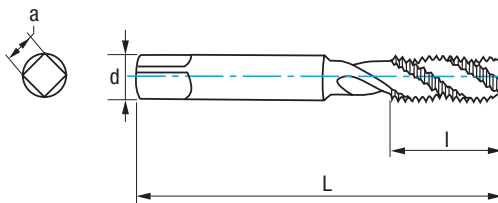

HSS
ISO 529
C 2-3h
Tol. 6H
 α 12-14°
35°
60°

Aceros <850 N/mm² Steel / Aciers
Cobre Copper Cuivre
Aluminio Aluminium



M	P	L mm	l mm	d mm	a mm	Z	Nº Art.	€	Nº Art. TIN	€
M3	0,50	48	11	3,15	2,50	3	38198	8,65	31723	11,40
M3,5	0,60	53	13	4,00	3,15	3	38199	13,70	70194	16,78
M4	0,70	53	13	4,00	3,15	3	38201	8,65	31724	11,73
M5	0,80	58	16	5,00	4,00	3	38206	8,65	31725	11,73
M6	1,00	66	19	6,30	5,00	3	38209	8,84	12168	11,92
M7	1,00	66	19	6,30	5,00	3	38211	14,01	70197	17,80
M8	1,25	72	22	8,00	6,30	3	38214	9,91	31726	13,70
M10	1,50	80	24	10,00	8,00	3	38216	12,77	31728	18,68
M12	1,75	89	29	9,00	7,10	3	38226	16,60	31756	23,05
M14	2,00	95	30	11,20	9,00	3	38228	22,69	31757	30,39
M16	2,00	102	32	12,50	10,00	3	38229	26,32	31758	35,69
New! M18	2,50	112	37	14,00	11,20	4	31627	39,62	31759	49,53
New! M20	2,50	118	38	16,00	12,50	4	31629	44,29	31760	56,23
New! M22	2,50	130	45	18,00	14,00	4	31630	51,20	31761	65,01
New! M24	3,00	135	45	20,00	16,00	4	31634	57,80	31762	83,89
New! M27	3,00	138	48	20,00	16,00	4	31635	71,18	31763	112,38
New! M30	3,50	151	51	22,40	18,00	4	31638	105,76	31764	146,96
New! M33	3,50	162	57	25,00	20,00	4	31586	132,52	31766	173,72
New! M36	4,00	170	60	28,00	22,40	4	31604	162,27	31767	210,75
New! M39	4,00	170	60	28,00	22,40	4	31606	181,83	31768	230,31
New! M42	4,50	187	67	31,50	25,00	4	31608	233,76	31769	291,44
New! M45	4,50	187	67	31,50	25,00	4	31612	295,26	31772	352,94
New! M48	5,00	187	67	31,50	25,00	4	31620	423,96	31775	485,51



Línea 33 cm
3157 -1-

MACHO HELICOIDAL MÁQUINA MÉTRICA NORMA ISO 529

ISO 529 Norm Standard Metric Machine Spiral Tap

Taraud hélicoïdal machine métrique norme ISO 529



ø	M3	M5	M6	M8	M10
Pcs	3	3	3	3	3

Ref. 4995 - N° Art. 70997: **146,48 €**

Línea 33 cm
3157 -2-

MACHO HELICOIDAL MÁQUINA MÉTRICA NORMA ISO 529

ISO 529 Norm Standard Metric Machine Spiral Tap

Taraud hélicoïdal machine métrique norme ISO 529



ø	M12	M14	M16
Pcs	3	3	3

Ref. 4995 - N° Art. 72127: **196,83 €**

Ref. **3500**

COJINETE MANO MÉTRICA / MÉTRICA FINA

Metric / Metric Fine Hand Die

Filière à main métrique / métrique pas fin



HSS

DIN
223

Tol.
6g

α
10-17°

Chafilán Entrada 1,75h
Chamfer 1,75 Threads
Chanfrein 1,75 filets

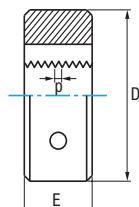

M/MF	P	D mm	E mm	Nº Art.	€
M2	0,40	16	5	63191	25,25
M2,5	0,45	16	5	75001	25,25
M3	0,50	20	5	63194	21,38
M3,5	0,60	20	5	63197	25,25
MF4	0,50	20	5	77025	34,74
M4	0,70	20	5	63200	21,38
M4,5	0,75	20	7	77028	23,33
MF5	0,50	20	5	77029	37,30
M5	0,80	20	7	63203	21,38
MF6	0,50	20	5	77034	37,30
MF6	0,75	20	7	77035	33,50
M6	1,00	20	7	63206	21,38
MF7	0,75	25	9	77037	23,61
M7	1,00	25	9	63209	23,33
MF8	0,50	25	9	77038	36,32
MF8	0,75	25	9	77039	36,32
MF8	1,00	25	9	63212	36,32
M8	1,25	25	9	63215	23,33
MF9	1,00	25	9	77041	40,41
M9	1,25	25	9	63218	31,08
MF10	0,75	30	11	77043	56,51
MF10	1,00	30	11	63221	44,42
MF10	1,25	30	11	63224	48,20
M10	1,50	30	11	63227	31,08
MF11	1,00	30	11	77045	55,27
MF11	1,25	30	11	77046	60,27
M11	1,50	30	11	63230	40,80
MF12	1,00	38	10	63233	56,20
MF12	1,25	38	10	63236	56,20
MF12	1,50	38	10	63239	50,24
M12	1,75	38	14	63242	33,02
MF13	1,00	38	10	77049	47,06
MF13	1,50	38	10	77050	49,48
MF14	1,00	38	10	63251	57,66
MF14	1,25	38	10	63254	61,42
MF14	1,50	38	10	63257	52,51
M14	2,00	38	14	63260	33,02
MF15	1,00	38	10	75307	53,52
MF15	1,50	38	10	77053	71,98
MF16	1,00	45	14	63266	77,99
MF16	1,25	45	14	77054	50,49
MF16	1,50	45	14	63269	72,12
M16	2,00	45	18	63272	44,67
MF18	1,00	45	14	77057	81,56
MF18	1,25	45	14	77058	66,01
MF18	1,50	45	14	63278	72,12
MF18	2,00	45	14	63281	81,56
M18	2,50	45	18	63284	44,67
MF20	1,00	45	14	77061	81,20
MF20	1,50	45	14	63287	74,43

M/MF	P	D mm	E mm	Nº Art.	€
MF20	2,00	45	14	63290	81,78
M20	2,50	45	18	63293	44,67
MF22	1,00	55	16	77066	110,89
MF22	1,50	55	16	63296	95,42
MF22	2,00	55	16	63299	106,14
M22	2,50	55	22	63302	66,06
MF24	1,00	55	16	77069	106,14
MF24	1,50	55	16	77070	95,42
MF24	2,00	55	16	63308	106,15
M24	3,00	55	22	63311	66,06
MF25	1,00	55	16	77072	143,05
MF25	1,50	55	16	77073	129,68
MF26	1,00	55	16	77075	154,86
MF26	1,50	55	16	77076	131,21
MF27	1,00	65	18	70103	113,80
MF27	1,50	65	18	77656	144,26
MF27	2,00	65	18	77079	156,91
M27	3,00	65	25	63314	99,07
MF28	1,50	65	18	77081	102,72
MF30	1,00	65	18	77082	120,61
MF30	1,50	65	18	77083	144,22
MF30	2,00	65	18	75310	161,08
M30	3,50	65	25	63317	99,07
MF32	1,50	65	18	77085	152,44
MF33	1,50	65	18	77088	144,26
MF33	2,00	65	18	77089	111,85
M33	3,50	65	25	77090	102,97
MF35	1,50	65	18	77093	156,11
MF36	1,50	65	18	75311	147,76
MF36	2,00	65	18	77095	157,08
MF36	3,00	65	25	77096	120,24
M36	4,00	65	25	77097	102,97
M39	4,00	75	30	77103	157,33
MF40	1,50	75	20	77104	233,14
MF40	2,00	75	20	77105	168,88
MF40	3,00	75	30	70104	184,20
MF42	2,00	75	20	77108	250,17
MF42	3,00	75	30	70106	232,51
M42	4,50	75	30	77110	157,33
MF45	1,50	90	22	77112	306,56
MF45	2,00	90	22	77113	258,72
MF45	3,00	90	36	77114	269,92
M45	4,50	90	36	77115	246,69
MF48	1,50	90	22	70107	232,91
MF48	3,00	90	36	35159	244,00
M48	5,00	90	36	77119	246,69
MF50	1,50	90	22	77120	306,56
MF52	1,50	90	22	77121	306,56
M52	5,00	90	36	77124	246,69

Sets
3500

COJINETE MANO MÉTRICA

Metric Hand Die
Filière à main métrique



7 Pcs

Cont. Ø	Nº Art.	€
Cojinetes / Dies / Filières DIN 223: M3-M4-M5-M6- M8-M10-M12	56518	172,96

Línea 33 cm
3500

COJINETE MANO MÉTRICA

Metric Hand Die
Filière à main métrique



Ø	M4	M5	M6	M8	M10	M12
Pcs	2	2	2	2	2	2

Ref. 4995 - Nº Art. 71001: **303,15 €**



Ref. **3005**

TERRAJA MONOBLOCK METAL

METAL Monoblock Die
Filière monoblock MÉTAL



HSS	DIN 223	Mano Hand Main	Tol. 6g	α 10-17°	Con Guía Guided Avec Guide
------------	---------	-----------------------	---------	-----------------	-----------------------------------

M	P	D mm	Nº Art.	€
M3	0,50	20	25226	21,74
M4	0,70	20	25227	21,74
M5	0,80	20	25228	21,74
M6	1,00	20	25229	22,15
M8	1,25	25	25231	23,34
M10	1,50	30	25233	30,79
M12	1,75	38	25581	32,70

Display
43



Ref. 3005	Ø	M-4	M-5	M-6	M-8	M-10	M-12
Pcs		2	2	2	2	2	2

Ref. 4995 - Nº Art. 32964: 304,95 €

Ref. **3006**

JUEGO TERRAJAS MONOBLOCK Y MACHOS MANO

Monoblock Die & Hand Tap Set
Jeu filières monoblock & tarauds à main

30 Pcs

Cont.	Nº Art.	€
Juegos Machos Tap Sets / Jeux Tarauds M3 - M4 - M5- M6 - M8 - M10 - M12	78141	170,40
Terrajas / Dies / Filières Monoblock Ref. 3005 M3 - M4 - M5- M6 - M8 - M10 - M12		
Gira-Machos Tap-Wrench / Porte-Tarauds M1 - M12		
Galga Gauge / Gabarit 1 pc		



Ref. **3536**

COJINETE MANO MÉTRICA / MÉTRICA FINA INOX

Stainless Metric / Metric Fine Hand Die

Filière à main métrique / métrique pas fin inox



HSSE 5% Co	DIN 22568	Tol. 6g	Métrica	α 20°		Vaporizado Vaporized Vaporisée
Aceros Steels Aciers	INOX Stainless Steel Acier INOX	Chafilán Entrada 2,25h Chamfer 2,25 Threads Chanfrein 2,25 filets				

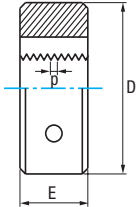

M	P	D mm	E mm	Nº Art.	€
M3	0,50	20	5	34255	23,51
M4	0,70	20	5	34256	23,51
M5	0,80	20	7	34257	23,51
M6	1,00	20	7	34258	23,73
M7	1,00	25	9	55515	25,56
M8	1,25	25	9	34259	25,56
MF10	0,75	30	11	81370	62,10
MF10	1,00	30	11	81371	48,81
MF10	1,25	30	11	81372	52,97
M10	1,50	30	11	34260	34,19
MF12	1,00	38	10	81373	61,76
MF12	1,25	38	10	81374	61,76
MF12	1,50	38	10	81375	55,21
M12	1,75	38	14	34261	44,19
MF14	1,00	38	10	81376	63,36
MF14	1,50	38	10	81377	57,70
M14	2,00	38	14	34262	44,19
MF15	1,00	38	10	81378	58,81
MF16	1,00	45	14	81379	92,53

M	P	D mm	E mm	Nº Art.	€
MF16	1,50	45	14	81380	83,52
M16	2,00	45	18	34263	61,28
MF17	1,00	45	14	81381	74,01
MF18	1,00	45	14	81382	89,63
MF18	1,50	45	14	81383	79,25
MF18	2,00	45	14	81384	89,63
M18	2,50	45	18	34264	61,28
MF20	1,00	45	14	81385	89,23
MF20	1,50	45	14	81386	81,79
MF20	2,00	45	14	81387	89,87
M20	2,50	45	18	34265	61,28
MF22	1,00	55	16	81388	132,89
MF22	1,50	55	16	81389	121,36
MF22	2,00	55	16	81390	132,89
M22	2,50	55	22	81391	115,68
MF24	1,50	55	16	81392	121,36
M24	3,00	55	22	81393	115,68
M27	3,00	65	25	81394	179,06
M30	3,50	65	25	81395	186,66
M33	3,50	65	25	83117	224,03



Set 7 Pcs

Cont.	Nº Art.	€
Cojinetes / Dies / Filières DIN 223: M3-M4-M5-M6-M8-M10-M12	76494	198,19

Línea 33 cm
3536

COJINETE MANO MÉTRICA INOX

STAINLESS Metric Hand Die

Filière à main métrique INOX



ø	M4	M5	M6	M8	M10	M12
Pcs	2	2	2	2	2	2

Ref. 4995 - Nº Art. 71005: 349,37 €

Ref. **3510**

COJINETE MANO MÉTRICA ISO

ISO Metric Hand Die
Filière à main métrique ISO

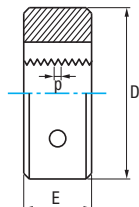

HSS

ISO
529

Ajustable
BS 1127 A
Adjustable

α
10-17°

Forma
A
Form

Tol.
6g



M	P	D mm	E mm	N° Art.	€
M3	0,50	25,4	9,5	38230	8,25
M4	0,70	25,4	9,5	38231	8,25
M5	0,80	25,4	9,5	38232	8,25
M6	1,00	25,4	9,5	38233	8,25
M7	1,00	25,4	9,5	38234	9,67
M8	1,25	25,4	9,5	38235	8,71
M10	1,50	25,4	9,5	38237	11,10
M12	1,75	25,4	9,5	38238	11,10

M	P	D mm	E mm	N° Art.	€
M8	1,25	38,1	12,7	38239	25,81
M10	1,50	38,1	12,7	38240	26,89
M12	1,75	38,1	12,7	38242	26,89
M14	2,00	38,1	12,7	38243	26,89
M16	2,00	38,1	12,7	38244	26,89
M18	2,50	38,1	12,7	38245	39,78
M20	2,50	38,1	12,7	38246	39,78

M	P	D mm	E mm	N° Art.	€
M18	2,50	50,8	15,9	38250	48,38
M20	2,50	50,8	15,9	38251	48,38
M22	2,50	50,8	15,9	38252	48,38
M24	3,00	50,8	15,9	38253	50,53

Línea 33 cm
3510

COJINETE MANO MÉTRICA ISO

ISO Metric Hand Die
Filière à main métrique ISO

16
cm



Ø	M4x25,4	M5x25,4	M6x25,4	M8x25,4	M10x25,4	M12x25,4
Pcs	2	2	2	2	2	2

Ref. 4995 - N° Art. 72129: 111,33 €

Ref. **3502**

COJINETE MANO WHITWORTH

Whitworth Hand Die
Filière à main Whitworth

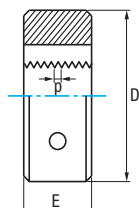

HSS

α
10-17°

W

DIN
223

Chaflán Entrada 1,75h
Chamfer 1,75 Threads
Chanfrein 1,75 Filets



W	Hilos Threads Filets	D mm	E mm	N° Art.	€
W3/32	48	16	5	63344	39,71
W1/8	40	20	5	63329	32,08
W5/32	32	20	7	63356	33,41
W3/16	24	20	7	63341	33,41
W7/32	24	20	7	63365	43,80
W1/4	20	20	7	63323	32,08
W5/16	18	25	9	63350	33,41
W3/8	16	30	11	63335	48,40

W	Hilos Threads Filets	D mm	E mm	N° Art.	€
W7/16	14	30	11	63362	48,40
W1/2	12	38	14	63320	48,40
W9/16	12	38	14	63368	57,96
W5/8	11	45	18	63347	70,41
W3/4	10	45	18	63332	70,41
W7/8	9	55	22	63359	103,53
W1"	8	55	22	63374	103,53
W1" 1/8	7	65	25	63383	162,96

Ref. **3546**

COJINETE MANO BSP (GAS) INOX

Stainless BSP (Gas) Hand Die
Filière à main BSP (Gaz) Inox

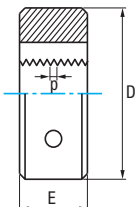

HSSE 5% Co	Gas (BSP)	DIN 24231	α 20°		Tol. A	Chafilán Entrada 2,25h Chamfer 2,25 Threads Chanfrein 2,25 filets
Rosca británica para tubo paralelo (BSPP-GAS) British Standard Parallel Pipe (BSPP-GAS) Filetage britannique pour tuyau parallèle (BSPP-GAS)						Vaporizado Vaporized Vaporisée
Aceros Steels Aciers		INOX Stainless Steel Acier INOX				



G	Hilos Threads Filets	D mm	E mm	Nº Art.	€
G1/8	28	30	11	81341	46,59
G1/4	19	38	10	81342	46,59
G3/8	19	45	14	81343	63,28
G1/2	14	45	14	81344	63,28
G3/4	14	55	16	81345	124,33
G1"	11	65	18	81346	190,02

Ref. **3506**

COJINETE MANO BSP (GAS)

BSP (Gas) Hand Die
Filière à main BSP (Gaz)

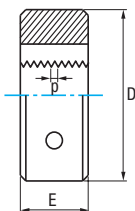

HSS	α 10-17°	Gas (BSP)	DIN 24231	Chafilán Entrada 1,75h Chamfer 1,75 Threads Chanfrein 1,75 filets	Vaporizado Vaporized Vaporisée
Rosca británica para tubo paralelo (BSPP-GAS) British Standard Parallel Pipe (BSPP-GAS) Filetage britannique pour tuyau parallèle (BSPP-GAS)					



G	Hilos Threads Filets	D mm	E mm	Nº Art.	€
G1/8	28	30	11	63461	42,35
G1/4	19	38	10	63455	42,35
G3/8	19	45	14	63467	54,78
G1/2	14	45	14	63452	54,78
G5/8	14	55	16	75496	83,59
G3/4	14	55	16	63464	113,53
G7/8	14	65	18	76252	118,84
G1"	11	65	18	63470	118,84
G1" 1/8	11	75	20	76202	217,67
G1" 1/4	11	75	20	76210	217,67
G1" 1/2	11	90	22	76224	217,67
New! G1" 3/4	11	105	22	76230	223,99
New! G2"	11	105	22	76236	269,57

Ref. **3191**

GIRA-MACHOS

Tap Wrench
Porte-taraud



DIN
1814



Mod.	Uso Use Usage	L mm	Cuadradillo Square / Carré mm	Nº Art.	€
000	M1-M8	125	2,10-4,90	69826	15,14
010	M1-M10	180	2,10-5,50	69828	15,82
015	M1-M12	200	2,10-7,00	69829	17,26
020	M4-M12	280	3,40-7,00	69831	22,07
030	M5-M20	375	4,90-12,00	69832	30,84

Mod.	Uso Use Usage	L mm	Cuadradillo Square / Carré mm	Nº Art.	€
040	M11-M27	500	6,20-16,00	69834	48,91
050	M13-M32	750	7,00-20,00	69835	101,20
* 060	M18-M42	870	7,00-28,00	83111	115,83
* 070	M25-M52	1250	16,00-32,00	26694	194,64
(New!) * 080	M25-M75	1015	14,50-40,00	24537	207,06

* Acero / Steel / Acier

Línea 33 cm
3191

GIRA-MACHOS

Tap Wrench
Porte-taraud



Mod.	000	010	015	020	030
Pcs	2	2	2	2	2

Ref. 4995 - Nº Art. 80556: 202,22 €

Ref. **3912**

GIRA-MACHOS CRIQUÉ

Tap Wrench
Porte-taraud



"T" +
Criqué



Mod.	M	L mm	Cap. mm	Nº Art.	€
01	M3-M10	85	2,4-5,5	25340	22,38
02	M5-M12	100	4,5-8,0	25341	30,40
10	M3-M10	250	2,4-5,5	25342	35,29
20	M5-M12	300	4,5-8,0	25343	42,09

Línea 33 cm
3912

GIRA-MACHOS CRIQUÉ

Tap Wrench
Porte-taraud



Mod.	01	02	10	20
Pcs	2	2	2	2

Ref. 4995 - Nº Art. 72135: 260,29 €

Ref. **9016**

BROCA METAL DURO DESTRUCTORA MACHOS

Tap Destroyer Solid Carbide Drill Bit
Foret carbure destructeur de tarauds

New!



MD / HM
Carbure
Grano UF

IZAR
Std.



HRC
50-65

Tol.
h6

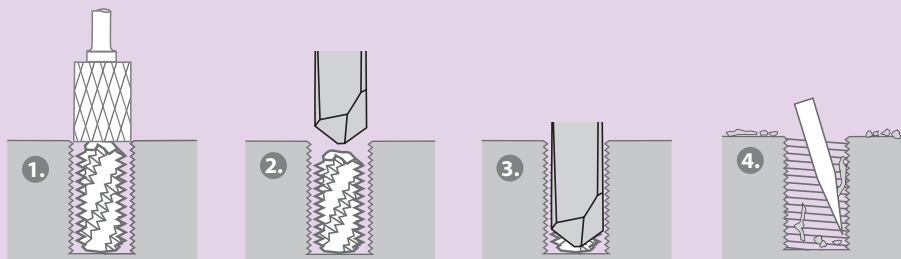

PROCEDIMIENTO PARA QUITAR MACHOS ROTOS:

1. Macho roto

Si sobresale alguna parte del macho roto, alisarla para poder taladrarlo más fácilmente.

2. Centrado de la broca

Colocar la broca sobre el centro del macho, fijando bien tanto la pieza de trabajo como la misma broca.

Sin lubricante, hacer un taladrado inicial de aproximación y retraer la broca rápidamente.

3. Proceso de taladrado

Taladrar a velocidad y avance fijos, y con paños para evacuar la viruta. Utilizar lubricación.

4. Sustraer el macho roto

Sustraer los restos del macho roto con un buril o instrumento similar.

PROCEDURE FOR REMOVING BROKEN TAPS:

1. Broken Tap

If any part of the broken tap is protruding, grind the surface in order to make it flat.

2. Centering of the Drill

Position the drill bit on the center of the broken tap. Please make sure that both the workpiece and the tap are firmly secured. Make an initial drill approach and retract the drill bit quickly. Don't use any lubrication.

3. Drilling

Drill the hole at a fixed speed and feed, stopping the process occasionally to remove the broken chips. Use lubrication in this step.

4. Chip Removal

The parts of the broken tap can be removed using a scriber or a similar tool.

PROCÉDURE POUR ENLEVER LES TARAUDS CASSÉS :

1. Taraud cassé

Si une partie du taraud dépasse, lissez la surface endommagée du taraud au ras de la pièce pour la percer plus facilement.

2. Centrage du foret

Placez le foret au centre du taraud. Assurez-vous que la pièce et le foret sont correctement centrés. Faites un premier perçage d'approximation, puis rétractez rapidement le foret. Pour cette étape, n'utilisez pas de lubrifiant.

3. Processus de perçage

Percez le trou à vitesse et avance fixes, en arrêtant de temps en temps pour évacuer les copeaux. Utilisez du lubrifiant.

4. Retirer les restes

Les restes peuvent être retirés en utilisant un burin ou similaire

- Diseño especial para retirar machos rotos.
- Requiere una buena sujeción de pieza y cabezal rígido.
- No válido para extraer machos de laminación.
- Specifically designed for removing broken taps.
- It is recommended to use a proper fixing with an stable chuck.
- Not suitable for forming taps.
- Conception spéciale pour enlever les tarauds cassés.
- Nécessite un bon serrage de la pièce et une tête rigide.
- Non valide pour retirer les tarauds réfileurs.

D mm	d mm	L mm	l mm	Macho * Tap - Taraud		Nº Art. MD/HM	€
2,00	3,00	38	10	M3	1	58951	36,87
3,00	3,00	38	15	M4 - M5	1	58954	36,87
4,00	4,00	50	20	M6	1	59987	50,71
5,00	5,00	50	25	M8 - M10	1	59989	57,08
6,00	6,00	60	30	M12	1	66145	63,38
7,00	8,00	79	35	M14	1	66399	84,63
8,00	8,00	79	40	M16	1	66407	84,63
9,00	10,00	100	45	M18	1	66408	109,49
10,00	10,00	100	50	M20	1	66409	109,49

* El ø de la broca deberá ser superior al ø núcleo del macho.
The ø of the drill bit must be greater than the ø of the tap core.
Le ø du foret doit être supérieur au ø du noyau du taraud.



Set 5 Pcs

Cont.	Nº Art.	€
2-3-4-5-6 mm	83426	232,67

Ref. **3409**

EXTRACTOR TORNILLOS

Screw Extractor
Extracteur vis



Mod.	P/ Tornillo F/ Screw P/Vis	P/ Tornillo F/ Screw P/Vis	D mm	a mm	Nº Art.	€
010	M3-M6	1/8-1/4	2,50	2,70	40639	2,99
020	M6-M8	1/4-5/16	3,00	3,80	40641	2,99
030	M8-M11	5/16-7/16	4,50	4,90	40642	3,12
040	M11-M14	7/16-9/16	6,00	7,00	40644	4,41
050	M15-M18	9/16-3/4	8,00	9,00	40645	6,91
060	M18-M24	3/4-1	11,00	12,00	40647	10,97



Set 5 Pcs

Set P/ Tornillo F/ Screw P/Vis	P/ Tornillo F/ Screw P/Vis	Nº Art.	€
M3-M18	1/8-3/4	75905	20,42

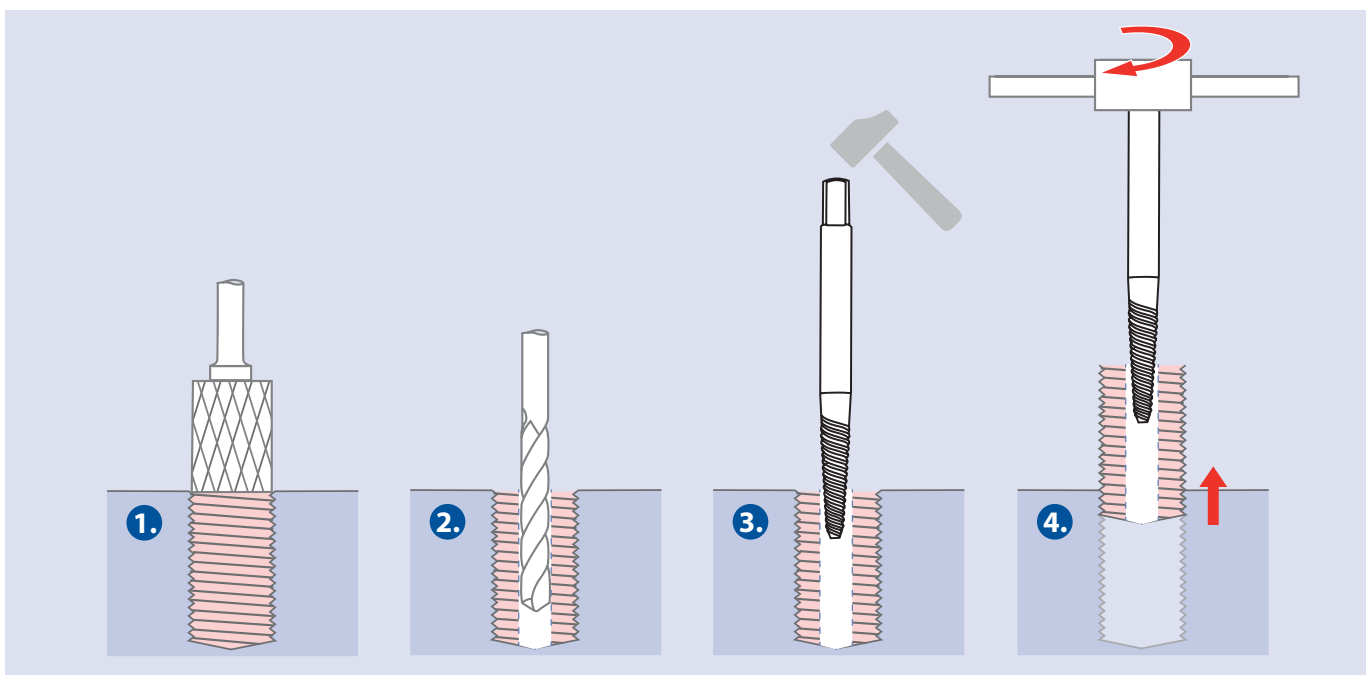

INSTRUCCIONES USO:

1. Alisar la superficie del tornillo con rotativa Ref. 9260.
2. Taladrar un agujero centrado con broca apropiada. Recomendamos Ref. 1016.
3. Introducir el extractor asegurándose de que quede fijo.
4. Girar el extractor hacia la izquierda hasta extraer el tornillo.

DIRECTIONS FOR USE:

1. Grind the surface of the screw head with Rotary Burr Ref. 9260.
2. Drill a hole on the screw using a suitable drill bit. We recommend our Ref. 1016.
3. Introduce the extractor and make sure it gets fixed/locked.
4. Turn left the extractor until the screw gets out.

INSTRUCTIONS D'EMPLOI:

1. Lissez la surface de la vis avec une fraise lime rotative Réf. 9260.
2. Percez un trou centré avec un foret approprié. Nous recommandons notre Réf. 1016.
3. Insérez l'extracteur et assurez-vous qu'il est fixé.
4. Tournez à gauche l'extracteur jusqu'à retirer la vis.

Línea 33 cm
3409

EXTRACTOR TORNILLOS

Screw Extractor
Extracteur vis



Mod.	10	20	30	40	50	60
Pcs	5	5	5	5	5	4

Ref. 4995 - Nº Art. 72139: 145,98 €

Ref. **3181**

PORTA-COJINETES

Die Holder
Porte filières



DIN
225



Mod.	D mm	E mm	L mm	M/MF	W	G	N° Art.	€
000	16	5	160	M1-M2,6	W1/16-W3/32		69792	8,47
010	20	5	200	M3-M4	W1/8-W5/32		69790	9,19
020	20	7	200	M4,5-M6	W3/16-W1/4		69798	9,19
030	25	9	224	M7-M9	W5/16	G1/16	69799	10,55
040	30	11	280	M10-M11	W3/8-W7/16	G1/8	69811	13,08
050	38	14	315	M12-M15	W1/2-W9/16		69813	16,60
060	38	10	315	MF12-MF15		G1/4	69814	16,60
070	45	18	450	M16-M20	W5/8-W3/4		69816	20,54
080	45	14	450	MF16-MF20		G3/8-G1/2	69817	20,54
090	55	22	560	M22-M24	W7/8-W1		69819	27,59
100	55	16	560	MF21-MF26		G5/8-G3/4	69795	26,28
110	65	25	630	M27-M36	W1 1/8 - W1 3/8		69796	38,72
120	65	18	630	MF27-MF36		G7/8-G1	30484	38,72
* 130	75	30	920	M39-M42	W1 1/2 - W1 5/8		32600	120,43
* 140	75	20	920	MF38-MF42		G1 1/8 - G1 1/4	43515	120,43
* 150	90	36	950	M45-M52	W1 3/4 - W2		43516	175,50
* 160	90	22	950	MF45-MF52		G1 1/2	43517	175,50

* Acero / Steel / Acier

Ref. **3184**

PORTA-COJINETES ISO 529

ISO 529 Die Holder
Porte filières ISO 529



DIN
225



D mm	E mm	M	W	N° Art.	€
25,40	9,50	M3-M12	W1/8-W1/2	43317	10,99
38,10	12,70	M8-M20	W5/16-W3/4	43318	16,42
50,80	15,90	M18-M24	W11/16-W1	43319	23,73

Ref. **3900**

GALGA

Pitch Gauge
Jauge



Cap. M	Cap. W	N° Art.	€
0,25-6,00	4G-62G	44612	7,89
0,40-6,00		67641	3,05

Ref. **3405**

JUEGO MACHOS MANO MÉTRICA

Metric Hand Tap Set
Jeu de tarauds à main métrique

Set 29 Pcs

Cont.		Nº Art.	€
Juegos Machos / Tap Sets / Jeux Tarauds	M3-M4-M5-M6-M8-M10-M12		
Brocas / Drill Bits / Forets mm	2,5-3,3-4,2-5,0-6,8-8,5-10,2	69624	102,05
Gira-Machos / Tap-Wrench / Porte-Tarauds	M1-M12		



Ref. **3404**

JUEGO MACHOS MANO PERFIL ROSCA COMPLETA

Whole Thread Profile Hand Tap Set
Jeu de tarauds à main profil filetage complet

Set 15 Pcs

Cont.		Nº Art.	€
Machos / Taps / Tarauds	M3-M4-M5-M6-M8-M10-M12		
Brocas / Drill Bits / Forets mm	2,5-3,3-4,2-5,0-6,8-8,5-10,2	68214	83,94
Gira-Machos / Tap-Wrench / Porte-Tarauds	M1-M12		



Ref. **3406**

JUEGO MACHOS Y COJINETES MANO MÉTRICA

Metric Hand Tap & Die Set
Jeu de tarauds et filières à main métrique



New! ISO

33 Pcs

Mod. 0 - Cont.

Juegos Machos Tap Sets / Jeux Tarauds	M3-M4-M5-M6-M8-M10-M12
Gira-Machos Tap-Wrench / Porte-Tarauds	M1-M12
Gira-Machos Tap-Wrench / Porte-Tarauds	Criqué M3-M10 Ratchet
Cojinetes Dies / Filières	M3-M4-M5-M6-M8-M10-M12
Porta-Cojinetes Die Holder / Porte-Filières	25x9
Galga Gauge / Gabarit	1 pc
Destornillador Screwdriver / Tournevis	1 pc



N° Art.	€
70527	129,72



N° Art.	€
18959	177,20

55 Pcs

Mod. 1 - Cont.

	N° Art.	€	
Juegos Machos Tap Sets / Jeux Tarauds	M3-M4-M5-M6-M8-M10-M12-M14-M16-M18-M20	38404	387,95
Gira-Machos Tap-Wrench / Porte-Tarauds	M1-M12, M5-M20		
Gira-Machos Tap-Wrench / Porte-Tarauds	Criqué M3-M10 + M5-M12 Ratchet		
Cojinetes Dies / Filières	M3-M4-M5-M6-M8-M10-M12-M14-M16-M18-M20		
Porta-Cojinetes Die Holder / Porte-Filières	20x5, 20x7, 25x9, 30x11, 38x14, 45x18		
Galga Gauge / Gabarit	1 pc		
Destornillador Screwdriver / Tournevis	1 pc		

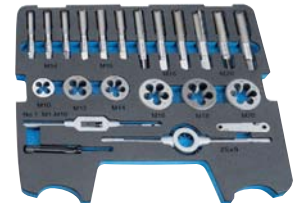

45 Pcs

Mod. 2 - Cont.

	N° Art.	€	
Juegos Machos Tap Sets / Jeux Tarauds	M3-M4-M5-M6-M8-M10-M12	38981	190,28
Gira-Machos Tap-Wrench / Porte-Tarauds	M1-M10, M4-M12		
Gira-Machos Tap-Wrench / Porte-Tarauds	Criqué M3-M10 Ratchet		
Cojinetes Dies / Filières	M3-M4-M5-M6-M8-M10-M12		
Porta-Cojinetes Die Holder / Porte-Filières	20x5, 20x7, 25x9, 30x11, 38x14		
Galga Gauge / Gabarit	1 pc		
Destornillador Screwdriver / Tournevis	1 pc		
Brocas Drill Bits / Forets mm	2,5-3,3-4,2-5,0-6,8-8,5-10,2		

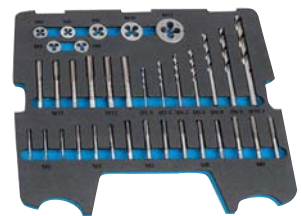



ACEITES DE CORTE Y REFRIGERANTES

Cutting Oils & Water Soluble Fluids

Huiles de coupe et lubrifiants

ACEITES DE CORTE

Aceite de corte de uso general de alta gama, formulado a base de aceites vegetales y libre de cloruros. Para aplicaciones de corte en general (taladrado, roscado, fresado, torneado, etc.)

Cutting Oils

High-end general purpose cutting oil, formulated from vegetable oils and chloride-free. For general cutting applications (drilling, threading, milling, turning, etc.)

Huiles de coupe

Huile de coupe à usage général haut de gamme, formulée à base d'huiles végétales et sans chlorures. Pour des applications de coupe en général (perçage, taraudage, fraisage, tournage, etc.).

REFRIGERANTES - TALADRINA

Aceite emulsionable altamente concentrado libre de cloruros, aminos secundarios y / o nitritos

Water Soluble Fluids

Highly concentrated emulsifiable oil free of chlorides, secondary amines and/or nitrites

Lubrifiants

Huile émulsifiable hautement concentrée, exempte de chlorures, d'amines secondaires et/ou de nitrites



ACEITES DE CORTE - Cutting Oils - Huiles de coupe

UNI

New!

Universal



Viscosidad a 40°C
Viscosity / Viscosité:
37 cSt

No
Soluble

- * Disponible Ficha Técnica
- * Data Sheet available
- * Fiche technique disponible

APLICACIÓN:

Para aplicaciones de uso general y universal (UNI) en todos los metales ferrosos.

APPLICATION:

For general purpose and universal (UNI) applications on all ferrous metals.

APPLICATION:

Pour des applications à usage général et universel (UNI) sur tous les métaux ferreux.



Cont.	250 ml
Nº Art.	53898
€	8,84

Cont.	500 ml
Nº Art.	53901
€	11,95

Cont.	1L
Nº Art.	53903
€	27,34

Cont.	5L
Nº Art.	53904
€	95,54

Cont.	10L
Nº Art.	53906
€	175,30

Cont.	25L
Nº Art.	53907
€	344,37

INOX

New!

Heavy Duty

VISCOSIDAD EXTRA !
Extra Viscosity!
Viscosité supplémentaire !

Viscosidad a 40°C
Viscosity / Viscosité:
173 cSt

No
Soluble

- * Disponible Ficha Técnica
- * Data Sheet available
- * Fiche technique disponible

APLICACIÓN:

Para aplicaciones de mecanizado pesado (Heavy Duty) en todos los metales ferrosos y para un rendimiento mejorado en aceros inoxidables (INOX).

APPLICATION:

For heavy duty machining applications on all ferrous metals and for improved performance on stainless steels (STAINLESS).

APPLICATION:

Pour des applications d'usinage lourd (Heavy Duty) sur tous les métaux ferreux et pour améliorer les performances sur les aciers inoxydables (INOX).



Cont.	250 ml
Nº Art.	53928
€	13,56

Cont.	500 ml
Nº Art.	53934
€	24,16

Cont.	1L
Nº Art.	53936
€	42,44

Cont.	5L
Nº Art.	53937
€	152,33

Cont.	10L
Nº Art.	53940
€	290,43

Cont.	25L
Nº Art.	53942
€	629,28

ALU

New!

Non Ferrous

Viscosidad a 40°C
Viscosity / Viscosité:
4,20 cSt

No
Soluble

- * Disponible Ficha Técnica
- * Data Sheet available
- * Fiche technique disponible

APLICACIÓN:

Especial para aplicaciones en todos los metales no ferrosos como aluminio (ALU), cobre, latón, bronce, zinc

APPLICATION:

Specially for applications on all non-ferrous metals such as aluminium (ALU), copper, brass, bronze, zinc, etc.

APPLICATION:

Spécialement indiqué pour les applications sur tous les métaux non ferreux, tels que l'aluminium (ALU), le cuivre, le laiton, le bronze, le zinc, etc.



Cont.	250 ml
Nº Art.	53943
€	12,23



Cont.	500 ml
Nº Art.	53946
€	19,96



Cont.	1L
Nº Art.	53948
€	33,42



Cont.	5L
Nº Art.	53949
€	123,67



Cont.	25L
Nº Art.	79042
€	563,29



New!

AEROSOL - Aerosol - Aérosol

2 Cánulas / 2 Actuators / 2 Canules



Chorro líquido
Liquid jet
Jet liquide

Cont.	400ml
Nº Art.	53900
€	15,21



Spray

Para aplicaciones de uso general en todos los metales ferrosos

For general purpose applications on all ferrous metals

Pour des applications à usage général sur tous les métaux ferreux



12 UNI

Nº Art.	€
53926	173,45
Box Price!	

New!

ESPUMA - Foam - Mousse

Fuerte adhesión sin goteos. Lavable con agua

Strong adherence without drips. Washable with water

Forte adhérence sans gouttes. Lavable à l'eau



Cont.	400ml
Nº Art.	48302
€	19,82



12 UNI

Nº Art.	€
48299	225,95
Box Price!	





New! DISPLAYS

9x250ml
UNI

Nº Art.	€
13929	75,56



UNI
Universal



UNI+INOX+ALU
3+3+3x250ml
MIXTO

Nº Art.	€
13930	98,68



UNI INOX ALU
Universal Heavy Duty Non Ferrous



6x400ml
AEROSOL

Nº Art.	€
13912	86,73



UNI
Universal



New! PASTA DE CORTE - Cutting Paste - Pâte de coupe

Pasta con propiedades lubricantes extremas. La pasta se asienta en las aristas de corte y se licua durante la operación de corte.

Ideal para todas las operaciones como roscado, taladrado y fresado de materiales difíciles de cortar como acero inoxidable, acero Cr-Ni, titanio, acero al manganeso, etc.

Paste with extreme lubricating properties. The paste settles on the cutting edges and liquefies during the cutting operation.

Ideal for all operations such as the threading, drilling and milling of difficult-to-cut materials such as stainless steel, Cr-Ni steel, titanium, manganese steel, etc.

Pâte aux propriétés lubrifiantes extrêmes. La pâte se dépose sur les bords de coupe et se liquéfie pendant l'opération de coupe.

Idéale pour toutes les opérations telles que le taraudage, le perçage et le fraisage de matériaux difficiles à couper comme l'acier inoxydable, l'acier Cr-Ni, le titane, l'acier au manganèse, etc.



Cont.	250ml
Nº Art.	53954
€	16,70



Cont.	750ml
Nº Art.	53956
€	27,81

Sumerja la herramienta de corte en la pasta para obtener resultados optimizados

Dip the cutting tool into the paste for optimised results

Trempez l'outil de coupe dans la pâte pour des résultats optimisés



New!

CERA DE CORTE - Cutting Wax - Cire de coupe

Cera en barra de alta gama para refrigerante y lubricación de operaciones de corte en metales no ferrosos como aluminio, cobre, latón, etc. Libre de cloruros, sin humos o vapores nocivos.

Para todas las máquinas de hoja de sierra circular o sierra de cinta sin suministro de refrigerante. También apto para fresado, roscado, escariado, taladrado, torneado, etc.

High-end wax in a bar for the cooling and lubrication of cutting operations on non-ferrous metals such as aluminium, copper, brass, etc. Chloride free, no harmful fumes or vapours.

For all circular or band saw blade machines without coolant supply. Also suitable for milling, threading, reaming, drilling, turning, etc.

Cire en barre haut de gamme pour le refroidissement et la lubrification des opérations de coupe sur les métaux non ferreux tels que l'aluminium, le cuivre, le laiton, etc. Sans chlorures, sans fumées ni vapeurs nocives.

Pour toutes les machines à lame de scie circulaire ou à ruban sans alimentation en réfrigérant. Convient également pour le fraisage, taraudage, alésage, perçage, tournage, etc.



Cont.	300ml
Nº Art.	53957
€	29,08



Para aplicar la cera, sostenga brevemente la barra de cera contra la sierra giratoria. Repita cada 10-20 ciclos de aserrado

To apply the wax, briefly hold the wax bar against the rotary saw. Repeat every 10-20 sawing cycles

Pour appliquer la cire, maintenez brièvement la barre de cire contre la scie rotative. Répétez tous les 10 à 20 cycles de sciage



REFRIGERANTES - TALADRINA Water Soluble Fluids - Lubrificants

STD

New!

Standard

Emulsión semisintética, transparente a semitransparente. Muy alta estabilidad ante los microorganismos. Apto para operaciones de rectificado. Concentración del 4-7% en función de la aplicación.

Semi-synthetic emulsion, transparent to semi-transparent. Very high stability to micro-organisms. Suitable for grinding operations. Concentration 4-7% depending on the application.

Émulsion semi-synthétique, transparente à semi-transparente. Très grande stabilité face aux microorganismes. Convient pour les opérations de meulage. Concentration de 4-7 % selon l'application.



 **Índice Refractómetro**
Refractometer Index
1,60
Indice de réfractomètre

- * Disponible Ficha Técnica
- * Data Sheet available
- * Fiche technique disponible

STANDARD

Cont.	5L
Nº Art.	53958
€	91,99

TOP

New!

Top Line

Emulsión de color blanco lechoso. Para aplicaciones de alto rendimiento en aceros, materiales no ferrosos y aluminio. Concentración 6-10% en función de la aplicación.

Milky white emulsion. For high performance applications on steels, non-ferrous materials and aluminium. Concentration 6-10% depending on application.

Émulsion blanche laiteuse. Pour des applications de haute performance sur les aciers, les matériaux non ferreux et l'aluminium. Concentration de 6-10 % selon l'application.



 **Índice Refractómetro**
Refractometer Index
1,20
Indice de réfractomètre

- * Disponible Ficha Técnica
- * Data Sheet available
- * Fiche technique disponible

TOP LINE

Cont.	5L
Nº Art.	53959
€	107,95



REPARADORES ROSCAS

Thread Repairs

Filets rapportés

Descripción

Desgaste, corrosión, excesiva torsión al ajustar el tornillo... son algunas de las causas que llevan a dañar una rosca sin posibilidad de reparación.

La gama de reparadores de roscas IZARCOIL permite reparar dichas roscas dañadas de manera rápida y económica.

Unos reparadores de acero de gran calidad, para crear una rosca resistente a la temperatura y la corrosión.

Ventajas

- Instalación rápida y sencilla
- Resistente al desgaste y a la tensión
- Resistente a la corrosión y termoestable

Ejemplos de aplicaciones

- Refuerzo para roscar materiales con una reducida resistencia (p.e. aleaciones de aluminio y aleaciones de magnesio)
- Ingeniería mecánica
- Ingeniería de automoción y electricidad

Description

Wear, corrosion or excessive screw tightening torque... are some of the reasons that lead to threads getting damaged beyond repair.

IZARCOIL thread repair range enables worn and damaged threads to be repaired quickly and at low cost.

In high-quality steel for a good thread, resistant to temperature and corrosion.

Advantages

- Fast and easy to install
- Stress resistant and wear-free
- Corrosion resistant and thermostable

Examples of Applications

- Thread reinforcement for materials with low shearing strength (e.g. aluminium or magnesium alloys)
- Mechanical engineering
- Automotive and electrical engineering

Description

Usure et trop de pression dans la fixation de la vis son des raisons pour endommager un filetage sans possibilité de réparation.

La gamme de filets rapportés IZARCOIL vous permet de réparer les filets endommagés rapidement et d'une façon économique.

Filets rapportés en aciers haute qualité pour avoir un filetage résistant à la température et à l'usure.

Avantages

- Installation rapide et simple
- Résistant à l'usure et a la tension
- Résistant aux variations de température

Exemples d'applications

- Soutien pour fileter aciers avec faible resistances (alliage aluminium et magnesium).
- Ingénierie mécanique
- Ingénierie auto et électricité

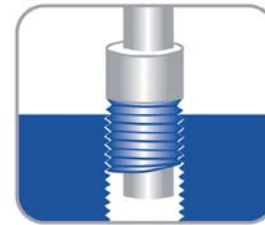
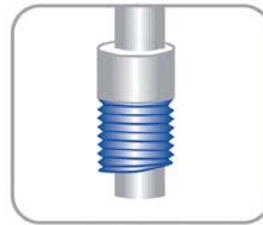

Uso

- 1- Taladrar la rosca dañada con una broca
- 2- Roscar con un macho IZARCOIL
- 3- Biselar el diámetro exterior a 90° y retirar la rebaba
- 4- Insertar el reparador de roscas con la ayuda del vástago
- 5- En caso de agujeros pasantes, usar un rompedor para la muesca

Use

- 1- Drill the thread with a Drill Bit
- 2- Thread with an IZARCOIL tap
- 3- Bevel the external diameter at 90° and remove the burr
- 4- Insert the thread repair using the fitting tool
- 5- In case of through holes, use a pin-breaker for the notch

Emploi

- 1- Percer le filet endommagé avec un foret
- 2- Tarauder avec un taraud IZARCOIL
- 3- Chanfreiner le diamètre extérieur à 90° et retirer les copeaux
- 4- Insérer le réparateur de filets avec l'aide du guide
- 5- Pour trous débouchants, employer un brise-copeaux



Ref. **3300**

INSERTO REPARACIÓN ROSCAS

Thread Repair Insert
Filet rapportés



INOX
304

M/MF

Aceros
Steels
Aciers

Aleaciones Alum. Alloys / Alliages
Aleaciones Mg Alloys / Alliages

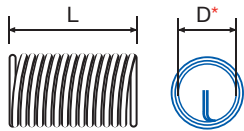

*D = M (aprox.)



M	P	L = 1xD			L = 1,5xD			L = 2xD			L = 2,5xD			L = 3xD		
			Nº Art.	€ 1 ud.		Nº Art.	€ 1 ud.		Nº Art.	€ 1 ud.		Nº Art.	€ 1 ud.		Nº Art.	€ 1 ud.
M3	0,50	25	56287	0,21	25	56288	0,21	25	56289	0,23	25	56291	0,27	25	56292	0,37
M4	0,70	25	56293	0,21	25	56294	0,21	25	56297	0,23	25	56299	0,27	25	56300	0,34
M5	0,80	25	56302	0,23	25	56303	0,21	25	56304	0,27	25	56306	0,33	25	56309	0,41
M6+ *	1,00	25	56310	0,23	25	56311	0,21	25	56312	0,27	25	56313	0,33	25	56315	0,49
New! M6-	* 1,00	25	14857	0,23	25	14859	0,21	25	14863	0,27	25	14865	0,33	25	14866	0,49
M7	1,00	25	56316	0,24	25	56318	0,30	25	56319	0,33	25	56320	0,38	25	56321	0,58
M8	1,00	25	56322	0,27	25	56324	0,30	25	56325	0,37	25	56326	0,45	25	56327	0,61
M8	1,25	25	56332	0,24	25	56333	0,27	25	56334	0,35	25	56336	0,43	25	56337	0,58
M9	1,25	25	56339	0,37	25	56340	0,43	25	56341	0,51	25	56342	0,53	25	56343	0,70
MF10	1,00	25	56344	0,30	25	56345	0,35	25	56346	0,40	25	56347	0,51	25	56348	0,68
MF10	1,25	25	56349	0,30	25	56351	0,35	25	56352	0,40	25	56353	0,51	25	56354	0,68
M10	1,50	25	56355	0,30	25	56357	0,35	25	56360	0,40	25	56361	0,51	10	56362	0,68
M11	1,50	25	56363	0,45	25	56364	0,61	10	56365	0,65	10	56366	0,82	10	56367	1,00
MF12	1,00	25	56369	0,38	25	56371	0,56	10	56372	0,64	10	56373	0,75	10	56374	1,00
MF12	1,25	25	56375	0,38	25	56377	0,56	10	56378	0,64	10	56379	0,75	10	56381	1,00
MF12	1,50	25	56384	0,38	25	56385	0,56	10	56387	0,64	10	56388	0,75	10	56389	1,00
M12	1,75	25	56390	0,38	25	56391	0,56	10	56392	0,64	10	56393	0,75	10	56394	1,00
MF14	1,00	10	56395	0,85	10	56396	0,87	10	56397	1,00	10	56399	1,21	10	56400	1,72
MF14	1,25	10	56401	0,71	10	56402	0,80	10	56403	0,85	10	56404	1,00	10	56405	1,33
MF14	1,50	10	56406	0,71	10	56407	0,80	10	56408	0,85	10	56409	1,00	10	56410	1,33
M14	2,00	10	58844	0,71	10	58845	0,80	10	58846	0,85	10	58847	1,01	10	58848	1,33
MF16	1,50	10	56411	0,94	10	56412	0,99	10	56413	1,23	10	56414	1,34	10	56416	1,72
M16	2,00	10	56417	0,94	10	56419	0,99	10	56420	1,23	10	56422	1,34	10	56423	1,72
MF18	2,00	10	56425	1,37	10	56427	1,60	10	56430	2,16	10	56431	2,46	10	56433	3,17
M18	2,50	10	56434	1,37	10	56436	1,60	10	56439	2,16	10	56440	2,46	10	56442	3,17
M20	2,50	10	67788	1,73	10	67790	2,16	10	67792	2,75	10	67794	3,13	10	70628	3,66
M22	2,50	10	56445	1,74	10	56446	2,16	10	56448	2,76	10	56451	3,15	10	56452	4,16
MF24	2,00	10	56454	2,16	10	56457	2,29	10	56458	2,90	10	56460	3,79	10	56463	4,43
M24	3,00	10	56464	2,16	10	56466	2,29	10	56467	2,90	10	56473	3,79	5	56476	4,43

* M6+ → ø7,6 - ø7,7

* M6- → ø7,3 - ø7,4

Ref. **3305**

MACHO PARA INSERTO REPARACIÓN ROSCAS

Thread Repair Insert Tap
Taraud filet rapportés



IZARCOIL

HSS

M/MF

Aceros
Steels
Aciers

Aleaciones Alum. Alloys / Alliages
Aleaciones Mg Alloys / Alliages



M	P	D mm	d mm	L mm	l mm	a mm	Z	Nº Art.	€
M3	0,50	3,65	4,00	53	13	3,15	3	56615	8,29
M4	0,70	4,91	5,00	58	16	4,00	3	56617	8,97
M5	0,80	6,04	6,30	66	19	5,00	3	56620	9,11
M6	1,00	7,30	8,00	72	22	6,30	3	56622	9,11
M7	1,00	8,30	9,00	72	22	7,10	3	56623	12,72
M8	1,00	9,30	10,00	80	24	8,00	3	56628	12,72
M8	1,25	9,62	10,00	80	24	8,00	3	56626	11,87
M9	1,25	10,60	8,00	85	25	6,30	3	56629	15,57
MF10	1,00	11,30	8,00	85	25	6,30	3	56638	15,57
MF10	1,25	11,62	8,00	85	25	6,30	3	56634	15,57
M10	1,50	11,95	9,00	89	29	7,10	3	56632	15,57
M11	1,50	12,95	9,00	89	29	7,10	3	56640	17,62
MF12	1,00	13,30	11,20	95	30	9,00	3	56646	21,52
MF12	1,25	13,62	11,20	95	30	9,00	3	56648	21,52
MF12	1,50	13,95	11,20	95	30	9,00	3	56647	21,52
M12	1,75	14,27	11,20	95	30	9,00	3	56644	16,71
MF14	1,00	15,30	12,50	102	32	10,00	3	56650	24,50
MF14	1,25	15,62	12,50	102	32	10,00	3	56652	24,50
MF14	1,50	15,95	12,50	102	32	10,00	3	56651	24,50
M14	2,00	16,70	12,50	102	32	10,00	4	58849	24,50
MF16	1,50	18,00	14,00	104	29	11,20	4	56654	29,32
M16	2,00	18,60	14,00	112	37	11,20	4	56653	29,32
MF18	2,00	20,60	14,00	104	29	11,20	4	56657	37,12
M18	2,50	21,30	16,00	118	38	12,50	4	56656	37,12
M20	2,50	23,32	16,00	118	38	12,50	4	72852	42,03
M22	2,50	25,30	18,00	130	45	14,00	4	56658	46,95
MF24	2,00	26,60	20,00	127	37	16,00	4	56660	59,35
M24	3,00	27,90	20,00	138	48	16,00	4	56659	59,35

D Broca Drill Bit / Punta mm
3,20
4,20
5,20
6,30
7,30
8,30
8,30
9,40
10,30
10,30
10,40
11,50
12,30
12,30
12,50
12,50
14,30
14,30
14,50
14,50
16,50
16,50
18,50
18,75
20,75
23,00
24,50
25,00



Ref. **3303**

INSERTADOR

Fitting Tool
Appareil de Pose



M	L mm	D mm		N° Art.	€
M3	132	2,20	1	70226	10,61
M4	132	3,00	1	66774	10,61
M5	132	4,00	1	66775	10,61
M6	132	4,90	1	66776	10,61
M8	132	6,50	1	66777	12,03
M10	132	7,00	1	66778	12,03
M12	132	9,50	1	66779	14,95
M14	132	11,00	1	66780	17,61
M16	132	12,75	1	79464	18,83
M18	132	14,90	1	79466	18,83
M20	132	15,95	1	79467	18,83
M22	132	17,95	1	83203	21,17
M24	132	20,00	1	79468	23,52

Ref. **3307**

ROMPE ARRASTRES

Pin-Breaker
Rupteur



M	L mm	D mm		N° Art.	€
M3	100	2,20	1	70238	4,55
M4	100	3,00	1	66781	4,55
M5	100	4,00	1	66782	4,55
M6	100	4,90	1	66783	4,55
M8	100	6,50	1	66784	4,98
M10	100	7,00	1	66785	4,98
M12	100	9,50	1	66786	5,98
M14	100	11,00	1	66787	7,96
M16	100	12,75	1	79470	8,51
M18	100	14,90	1	79476	8,51
M20	100	15,95	1	79477	8,51
M22	100	17,95	1	83205	9,58
M24	100	20,00	1	79478	10,63



Ref. **3310**

SET REPARACIÓN ROSCAS

Thread Repair Set
Set filet rapportés



M

Aceros
Steels
Aciers

Aleaciones Alum. Alloys / Alliages
Aleaciones Mg Alloys / Alliages



Set 95 Pcs

		Cont. M5-M12	Nº Art.	€		
Insertos Inserts Rapportes		M5 0,80 5 pcs 1xD + 5 pcs 1,5xD + 5 pcs 2,5XD M6 1,00 5 pcs 1xD + 5 pcs 1,5xD + 5 pcs 2,5XD M8 1,25 5 pcs 1xD + 5 pcs 1,5xD + 5 pcs 2,5XD M10 1,50 5 pcs 1xD + 5 pcs 1,5xD + 5 pcs 2,5XD M12 1,75 5 pcs 1xD + 5 pcs 1,5xD + 5 pcs 2,5XD	56481	267,19		
		Brocas Drill Bits Forets (D mm)				5,20 - 6,30 - 8,30 - 10,40 - 12,50
		Machos Taps Tarauds (D mm)				6,04 - 7,30 - 9,62 - 11,95 - 14,27
		Insertadores Fitting Tools Appareils de pose (D mm)				4,00 - 4,50 - 6,25 - 7,20 - 9,50
		Rompe arrastres Pin-Breakers Rupteurs (D mm)				4,00 - 4,50 - 6,25 - 7,20 - 9,50

Ref. **3311**

SET REPARACIÓN ROSCAS BUJÍAS

Spark Plug Thread Repair Set
Set filet rapportés bougies



M/MF



Aceros
Steels
Aciers

Aleaciones Alum. Alloys / Alliages
Aleaciones Mg Alloys / Alliages



Set 94 Pcs

		Cont. M6-M14	Nº Art.	€		
Insertos Inserts Rapportes		M6 1,00 5 pcs 1xD + 5 pcs 1,5xD + 5 pcs 2,5XD M8 1,25 5 pcs 1xD + 5 pcs 1,5xD + 5 pcs 2,5XD M10 1,50 5 pcs 1xD + 5 pcs 1,5xD + 5 pcs 2,5XD M12 1,75 5 pcs 1xD + 5 pcs 1,5xD + 5 pcs 2,5XD MF14 1,25 5 pcs 1xD + 5 pcs 1,5xD + 5 pcs 2,5XD	56482	307,90		
		Brocas Drill Bits Forets (D mm)				6,30 - 8,30 - 10,40 - 12,50
		Machos Taps Tarauds (D mm)				7,30 - 9,62 - 11,95 - 14,27 - 15,60
		Insertadores Fitting Tools Appareils de pose (D mm)				4,50 - 6,25 - 7,20 - 9,50 - 11,00
		Rompe arrastres Pin-Breakers Rupteurs (D mm)				4,50 - 6,25 - 7,20 - 9,50 - 11,00

Ref. **3312**

SET REPARACIÓN ROSCAS COMPLETO

Complete Thread Repair Set
Set filet rapportés complet



M/MF

Aceros
Steels
Aciers

Aleaciones Alum. Alloys / Alliages
Aleaciones Mg Alloys / Alliages

Set 19 Pcs

M	P	Insertos Inserts Rapportés	INOX 304	Brocas Drill Bits Forets (D mm)	HSS	Machos Taps Tarauds (D mm)	HSS	Insertadores Fitting Tools Appareils de pose (D mm)	Rompe arrastres Pin-Breakers Rupteurs (D mm)	Nº Art.	€
M3	0,50	5 pcs 1xD + 5 pcs 1,5xD + 5 pcs 2,5xD		3,20		3,65		2,20	2,20	60330	37,92
M4	0,70	5 pcs 1xD + 5 pcs 1,5xD + 5 pcs 2,5xD		4,20		4,91		3,00	3,00	56484	37,92
M5	0,80	5 pcs 1xD + 5 pcs 1,5xD + 5 pcs 2,5xD		5,20		6,04		4,00	4,00	56487	37,73
M6	1,00	5 pcs 1xD + 5 pcs 1,5xD + 5 pcs 2,5xD		6,30		7,30		4,90	4,90	56488	40,62
M7	1,00	5 pcs 1xD + 5 pcs 1,5xD + 5 pcs 2,5xD		7,30		8,30		4,90	4,90	67804	49,44
MF8	1,00	5 pcs 1xD + 5 pcs 1,5xD + 5 pcs 2,5xD		8,30		9,30		6,50	6,50	56497	49,44
M8	1,25	5 pcs 1xD + 5 pcs 1,5xD + 5 pcs 2,5xD		8,30		9,62		6,50	6,50	56490	49,44
(New!) MF10	1,00	5 pcs 1xD + 5 pcs 1,5xD + 5 pcs 2,5xD		10,30		11,30		7,00	7,00	12675	55,31
MF10	1,25	5 pcs 1xD + 5 pcs 1,5xD + 5 pcs 2,5xD		10,30		11,62		7,00	7,00	56500	55,31
M10	1,50	5 pcs 1xD + 5 pcs 1,5xD + 5 pcs 2,5xD		10,40		11,95		7,00	7,00	56493	55,31
MF12	1,00	5 pcs 1xD + 5 pcs 1,5xD + 5 pcs 2,5xD		12,30		13,30		9,50	9,50	57967	63,44
MF12	1,50	5 pcs 1xD + 5 pcs 1,5xD + 5 pcs 2,5xD		12,50		13,95		9,50	9,50	57964	63,44
M12	1,75	5 pcs 1xD + 5 pcs 1,5xD + 5 pcs 2,5xD		12,50		14,27		9,50	9,50	56496	63,44
MF14	1,25	5 pcs 1xD + 5 pcs 1,5xD + 5 pcs 2,5xD		*14,30		15,62		11,00	11,00	57973	64,45
M14	2,00	5 pcs 1xD + 5 pcs 1,5xD + 5 pcs 2,5xD		*14,50		16,60		11,00	11,00	57970	72,92
(New!) MF16	1,50	5 pcs 1xD + 5 pcs 1,5xD + 5 pcs 2,5xD		*16,50		18,00		12,75	12,75	23220	83,93
(New!) M16	2,00	5 pcs 1xD + 5 pcs 1,5xD + 5 pcs 2,5xD		*16,50		18,60		12,75	12,75	23221	83,93

* Diámetro de broca correspondiente. Broca no incluida

Corresponding drill bit diameter. Drill bit not included

Diamètre de foret correspondant. Foret non inclus

FRESAS ROTATIVAS

Rotary Burrs

Fraises limes rotatives

Ref. **9260**

FRESA ROTATIVA MD TIPO B

B Type HM Rotary Burr

Fraise lime rotative carbure type B



MD
HM
Carbure

MD/HM
+
ALTIN

Tipo
B
Type

Norma
ZYA-S
Norm

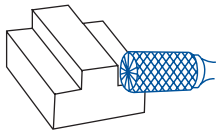
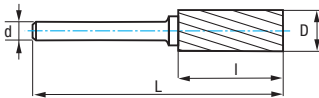

1
MATERIALES NO FERROSOS
Non-Ferrous Materials
Matériaux non ferreux



3
USO GENERAL
General Purpose
Utilisation Générale



4
VIRUTA CORTA
Short Chipping
Copeaux Courts

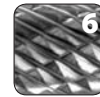

6
MATERIALES DUROS
Hard Materials
Matériaux Durs



D mm	d mm	L mm	l mm	Dentado Teeth / Denture 1		Dentado Teeth / Denture 1 ALTIN		Dentado Teeth / Denture 3		Dentado Teeth / Denture 4		Dentado Teeth / Denture 6		Dentado Teeth / Denture 6 ALTIN	
				Nº Art.	€	Nº Art.	€	Nº Art.	€	Nº Art.	€	Nº Art.	€	Nº Art.	€
3,00	3,00	38,00	14,00	55677	11,37			44072	10,05	44079	11,37	44086	11,00	66485	17,87
6,00	6,00	50,00	18,00	55680	24,33			44074	21,42	44081	24,33	44141	23,59	66486	31,07
6,30	3,00	45,00	12,70	55679	19,78			44073	16,95	44080	19,78	44122	18,65		
8,00	6,00	64,00	19,00	55681	30,69			44075	25,57	44082	30,69	44142	28,12	66487	36,11
9,60	6,00	64,00	19,00	44070	34,81	55864	42,12	44076	29,04	44083	34,81	44143	31,92	43567	38,64
12,70	6,00	70,00	25,00	44071	46,93	55866	76,29	44077	40,75	44084	48,93	44144	44,86	66488	69,99
12,70	8,00	70,00	25,00	55691	46,95			55689	39,16			55690	43,08		
16,00	6,00	70,00	25,00	55682	63,85			44078	53,22	44085	63,85	44145	58,52		
16,00	8,00	70,00	25,00	55695	59,20			55692	49,36			55693	54,30		
19,00	6,00	70,00	25,00	55685	88,04			55683	73,43			55684	80,77		
25,00	6,00	70,00	25,00	55688	123,10			55686	102,66			55687	112,93		

Línea 33 cm
9200

FRESAS ROTATIVAS

Rotary Burrs

Fraises limes rotatives



Ref	9251	9251	9251	9251	9260	9260
Diam	6x6	8x6	9,6x6	12,7x6	9,6x6	12,7x6
Dent./Teeth	6	6	6	6	6	6
Pcs.	2	2	2	2	2	2

Ref. 4995 - Nº Art. 71009: 411,95 €

Ref. **9250**

FRESA ROTATIVA MD TIPO A

A Type HM Rotary Burr
Fraise lime rotative carbure type A



MD
HM
Carbure

MD/HM
+
ALTIN

Tipo
A
Type

Norma
ZYA
Norm

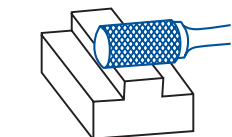
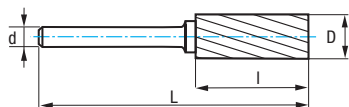

1
MATERIALES NO FERROSOS
Non-Ferrous Materials
Matériaux non ferreux



3
USO GENERAL
General Purpose
Utilisation Générale



4
VIRUTA CORTA
Short Chipping
Copeaux Courts



6
MATERIALES DUROS
Hard Materials
Matériaux Durs

D mm	d mm	L mm	I mm	Dentado Teeth / Denture 1		Dentado Teeth / Denture 1 ALTIN		Dentado Teeth / Denture 3		Dentado Teeth / Denture 4		Dentado Teeth / Denture 6		Dentado Teeth / Denture 6 ALTIN	
				Nº Art.	€	Nº Art.	€	Nº Art.	€	Nº Art.	€	Nº Art.	€	Nº Art.	€
3,00	3,00	38,00	14,00	55644	10,38			44149	8,99	44156	10,38	44245	9,88	66489	16,20
6,00	6,00	50,00	18,00	55648	22,10			44151	19,36	44158	22,10	44417	21,27	66490	27,95
6,30	3,00	45,00	12,70	55645	17,97			44150	15,20	44157	17,97	44301	16,73		
8,00	6,00	64,00	19,00	55651	28,19			44152	23,50	44159	28,19	44418	25,83	66491	32,86
9,60	6,00	64,00	19,00	44147	31,49	55861	47,86	44153	26,26	44160	31,49	44419	28,90	63933	43,92
12,70	6,00	70,00	25,00	44148	42,67	55863	69,37	44154	37,32	44161	44,77	44421	41,04	66492	63,64
12,70	8,00	70,00	25,00	55671	44,73			55669	37,32			55670	41,04		
16,00	6,00	70,00	25,00	55653	58,05			44155	48,37	44173	58,05	44422	53,22		
16,00	8,00	70,00	25,00	55675	53,81			55672	44,88			55673	49,36		
19,00	6,00	70,00	25,00	55664	80,04			55655	66,75			55657	73,43		
25,00	6,00	70,00	25,00	55668	111,91			55666	93,33			55667	102,67		

Ref. **9251**

FRESA ROTATIVA MD TIPO C RADIAL

Radial C Type HM Rotary Burr
Fraise lime rotative carbure type C hemisphérique



MD
HM
Carbure

MD/HM
+
ALTIN

Tipo
C
Type

Norma
WRC
Norm

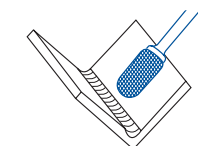
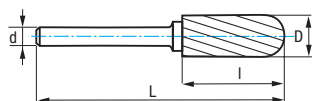

1
MATERIALES NO FERROSOS
Non-Ferrous Materials
Matériaux non ferreux



3
USO GENERAL
General Purpose
Utilisation Générale



4
VIRUTA CORTA
Short Chipping
Copeaux Courts



6
MATERIALES DUROS
Hard Materials
Matériaux Durs



S
TITANIO, INCONEL...
Titanium, Inconel...
Titane, Inconel...

D mm	d mm	L mm	I mm	Dentado Teeth / Denture 1		Dentado Teeth / Denture 1 ALTIN		Dentado Teeth / Denture 3		Dentado Teeth / Denture 4		Dentado Teeth / Denture 6		Dentado Teeth / Denture 6 ALTIN		Dentado Teeth / Denture S ALTIN	
				Nº Art.	€	Nº Art.	€	Nº Art.	€	Nº Art.	€	Nº Art.	€	Nº Art.	€	Nº Art.	€
3,00	3,00	38,00	14,00	55696	13,29			44425	11,06	44431	13,29	44437	12,16	66493	16,20	83022	16,20
6,00	6,00	50,00	18,00	55698	24,90			44426	20,72	44432	24,90	44438	22,81	66494	28,64		
8,00	6,00	64,00	18,00	55699	30,69			44427	25,57	44433	30,69	44439	28,12	66495	35,75		
9,60	6,00	64,00	19,00	44423	35,65	55867	53,29	44428	29,70	44434	35,65	44440	32,67	66496	48,89		
12,70	6,00	70,00	25,00	44424	49,74	55868	77,80	44429	41,47	44435	49,74	44441	45,60	66497	71,37		
12,70	8,00	70,00	25,00	55708	47,87			55706	39,93			55707	43,93				
16,00	6,00	70,00	25,00	12138	64,67			44430	53,90	44436	64,67	44442	59,30				
16,00	8,00	70,00	25,00	55711	60,25			55709	50,24			55710	55,27				
19,00	6,00	70,00	25,00	55702	86,49			55700	72,13			55701	79,35				
25,00	6,00	70,00	25,00					55704	98,01			55705	107,79				

Ref. **9252**

FRESA ROTATIVA MD TIPO N CONO INVERTIDO

Inverted Cone N Type HM Rotary Burr
Fraise lime rotative carbure type N sans coupe en bout



MD
HM
Carbure

Tipo
N
Type

Norma
WKN
Norm

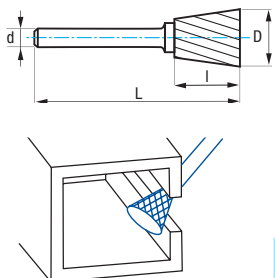

3
USO GENERAL
General Purpose
Utilisation Générale



4
VIRUTA CORTA
Short Chipping
Copeaux Courts



6
MATERIALES DUROS
Hard Materials
Matériaux Durs

D mm	d mm	L mm	l mm	Ang.	Dentado Teeth / Denture 3		Dentado Teeth / Denture 4		Dentado Teeth / Denture 6	
					Nº Art.	€	Nº Art.	€	Nº Art.	€
3,00	3,00	38,00	4,00	10°	44443	11,06	44450	13,29	44455	12,16
6,00	6,00	50,00	8,00	10°	44447	19,36	44452	23,22	44458	21,28
6,30	3,00	39,00	6,00	12°	44445	17,29	44451	20,74	44457	19,03
12,70	6,00	57,00	12,00	28°	44448	30,51	44453	36,61	44460	33,55
12,70	8,00	58,00	12,70	28°	55825	39,70			55826	43,68
16,00	6,00	64,00	19,00	18°	44449	51,00	44454	61,13	44461	56,08
16,00	8,00	64,00	19,00	18°	55827	51,00			55828	56,08
19,00	6,00	61,00	16,00	30°	55823	57,29			55824	63,02

Ref. **9254**

FRESA ROTATIVA MD TIPO G OJIVA

Tree G Type HM Rotary Burr
Fraise lime rotative carbure type G ogive



MD
HM
Carbure

MD/HM
+
ALTIM

Tipo
G
Type

Norma
SPG
Norm

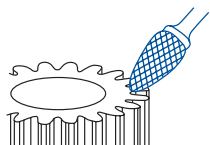
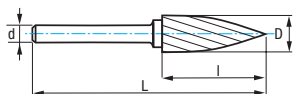

1
MAT. NO FERROSOS
Non-Ferrous Mat.
Mat. non ferreux



3
USO GENERAL
General Purpose
Utilisation Générale



4
VIRUTA CORTA
Short Chipping
Copeaux Courts



6
MATERIALES DUROS
Hard Materials
Matériaux Durs

D mm	d mm	L mm	l mm	Dentado Teeth / Denture 1		Dentado Teeth / Denture 3		Dentado Teeth / Denture 4		Dentado Teeth / Denture 6		Dentado Teeth / Denture 6 ALTIM	
				Nº Art.	€	Nº Art.	€	Nº Art.	€	Nº Art.	€	Nº Art.	€
3,00	3,00	38,00	14,00	55783	13,29	44466	11,06	44472	13,29	44487	12,16	66505	16,20
6,00	6,00	50,00	18,00	55784	24,90	44467	20,72	44473	24,90	44488	22,81	66506	28,36
8,00	6,00	64,00	19,00	55785	28,19	44468	23,50	44474	28,19	44494	25,79		
9,60	6,00	64,00	19,00	44463	33,17	44469	27,66	44475	33,17	44500	30,40	55882	40,83
12,70	6,00	70,00	25,00	44464	41,47	44470	34,55	44476	41,47	44512	38,01	27566	51,56
12,70	8,00	70,00	25,00	55787	43,22	17105	36,04			55786	39,67		
16,00	6,00	70,00	25,00					44482	58,05				
16,00	6,00	75,00	30,00	44465	58,05	44471	48,37			44518	53,22		
16,00	8,00	70,00	25,00	55790	60,12	55788	50,15			55789	55,16		

Ref. **9255**

FRESA ROTATIVA MD TIPO M CÓNICA

Cone M Type HM Rotary Burr
Fraise lime rotative carbure type M conique



MD
HM
Carbure

Tipo
M
Type

Norma
SKM
Norm

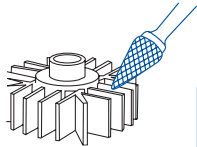
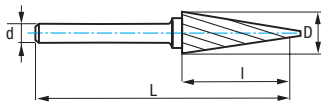

1
MAT. NO FERROSOS
Non-Ferrous Mat.
Mat. non ferreux



3
USO GENERAL
General Purpose
Utilisation Générale



4
VIRUTA CORTA
Short Chipping
Copeaux Courts



6
MATERIALES DUROS
Hard Materials
Matériaux Durs

D mm	d mm	L mm	l mm	Ang.	Dentado Teeth / Denture 1		Dentado Teeth / Denture 3		Dentado Teeth / Denture 4		Dentado Teeth / Denture 6	
					Nº Art.	€	Nº Art.	€	Nº Art.	€	Nº Art.	€
6,00	6,00	50,00	20,00	14°	55817	22,97	44530	19,13	44598	22,97	44616	21,04
6,30	3,00	49,00	12,70	22°	55816	19,13	44524	15,96	44595	19,13	44613	17,54
8,00	6,00	64,00	18,00	22°			44583	20,42	44601	24,50	44617	22,47
9,60	6,00	64,00	16,00	28°	55818	27,56	44586	22,97	44604	27,56	44619	25,27
12,70	6,00	71,00	22,00	28°	25335	36,76	44589	30,60	44607	36,76	44620	33,68
12,70	8,00	71,00	22,00	28°			55819	39,87			55820	43,86
16,00	6,00	71,00	25,00	31°			44592	41,47	44610	49,75	44622	45,60
16,00	8,00	71,00	25,00	31°			55821	53,21			55822	58,53

Ref. **9256**

FRESA ROTATIVA MD TIPO K CÓNICA 90°

90° Cone K Type HM Rotary Burr
Fraise lime rotative carbure type K conique 90°



MD
HM
Carbure

Tipo
K
Type

Norma
KSK
Norm

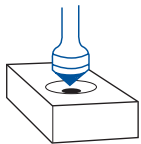
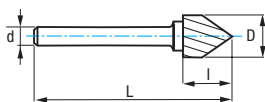

3
USO GENERAL
General Purpose
Utilisation Générale



4
VIRUTA CORTA
Short Chipping
Copeaux Courts



6
MATERIALES DUROS
Hard Materials
Matériaux Durs

D mm	d mm	L mm	l mm	Dentado Teeth / Denture 3		Dentado Teeth / Denture 4		Dentado Teeth / Denture 6	
				Nº Art.	€	Nº Art.	€	Nº Art.	€
6,00	6,00	50,00	3,00	44625	16,59	44628	19,89	44631	18,25
12,70	6,00	55,00	6,30	44626	27,66	44629	33,15	44632	30,40
12,70	8,00	55,00	6,30	55802	27,59			55803	30,36
16,00	6,00	57,00	8,00	55796	36,77			55797	40,44
16,00	8,00	57,00	8,00	55804	36,77			55805	40,44
19,00	6,00	59,00	9,50	55798	48,27			55799	53,11
25,00	6,00	61,00	12,70	55800	77,45			55801	85,19



Ref. **9257**

FRESA ROTATIVA MD TIPO E GOTA

Oval E Type HM Rotary Burr
Fraise lime rotative carbure type E ovale



MD HM Carbure	Tipo E Type	Norma TRE Norm
----------------------------	--------------------------	-----------------------------

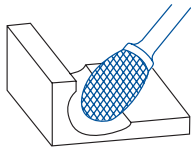
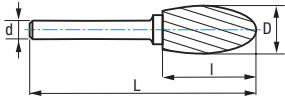

1
MAT. NO FERROSOS
Non-Ferrous Mat.
Mat. non ferreux



3
USO GENERAL
General Purpose
Utilisation Générale



4
VIRUTA CORTA
Short Chipping
Copeaux Courts



6
MATERIALES DUROS
Hard Materials
Matériaux Durs



D mm	d mm	L mm	l mm	Dentado Teeth / Denture 1		Dentado Teeth / Denture 3		Dentado Teeth / Denture 4		Dentado Teeth / Denture 6	
				Nº Art.	€	Nº Art.	€	Nº Art.	€	Nº Art.	€
3,00	3,00	38,00	6,00	55733	13,29	44637	11,06	44648	13,29	44655	12,16
6,00	6,00	50,00	10,00	55735	24,90	44640	20,72	44650	24,90	44657	22,81
6,30	3,00	42,00	9,50	55734	20,72	44638	17,29	44649	20,72	44656	19,00
8,00	6,00	60,00	15,00	55737	28,19	44643	23,50	44651	28,19	44658	25,83
9,60	6,00	61,00	16,00	44634	33,17	44644	27,66	44652	33,17	44659	30,40
12,70	6,00	67,00	22,00	44635	41,47	44646	34,55	44653	41,47	44660	38,01
12,70	8,00	67,00	22,00	55746	44,58	55743	37,21			55744	40,91
16,00	6,00	70,00	25,00	55738	58,05	44647	48,37	44654	58,05	44661	53,22
16,00	8,00	70,00	25,00	55749	61,97	55747	51,69			55748	56,85
19,00	6,00	70,00	25,00	55741	83,23	55739	69,41			55740	76,35

Ref. **9258**

FRESA ROTATIVA MD TIPO D ESFÉRICA

Ball D Type HM Rotary Burr
Fraise lime rotative carbure type D sphérique



MD HM Carbure	MD/HM + ALTIM	Tipo D Type	Norma KUD Norm
----------------------------	----------------------------	--------------------------	-----------------------------

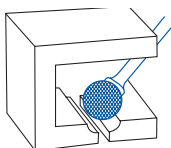
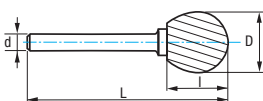

1
MATERIALES NO FERROSOS
Non-Ferrous Materials
Matériaux non ferreux



3
USO GENERAL
General Purpose
Utilisation Générale



4
VIRUTA CORTA
Short Chipping
Copeaux Courts



6
MATERIALES DUROS
Hard Materials
Matériaux Durs



D mm	d mm	L mm	l mm	Dentado Teeth / Denture 1		Dentado Teeth / Denture 1 ALTIM		Dentado Teeth / Denture 3		Dentado Teeth / Denture 4		Dentado Teeth / Denture 6		Dentado Teeth / Denture 6 ALTIM	
				Nº Art.	€	Nº Art.	€	Nº Art.	€	Nº Art.	€	Nº Art.	€	Nº Art.	€
3,00	3,00	38,00	2,50	55713	12,26			44705	10,21	44712	12,26	44719	11,20	66498	16,20
6,00	6,00	50,00	4,70	55716	22,97			44707	19,13	44714	22,97	44721	21,04	66499	26,10
6,30	3,00	38,00	5,00	55714	19,13			44706	15,96	44713	19,13	44720	17,54		
8,00	6,00	52,00	6,00	55717	26,04			44708	21,70	44715	26,04	44722	23,82	66500	28,89
9,60	6,00	54,00	8,00	44662	29,09	55869	43,73	44709	24,23	44716	29,09	44723	26,63	66501	40,11
12,70	6,00	56,00	11,00	44671	36,76	55870	54,80	44710	30,60	44717	36,76	44724	33,68	66502	50,29
12,70	8,00	56,00	11,00	55728	33,73			55725	28,12			55726	30,94		
16,00	6,00	59,00	14,00	58481	51,80			44711	43,35	44718	52,04	44725	47,52		
16,00	8,00	59,00	14,00	55732	41,80			55729	34,85			55731	38,35		
19,00	6,00	62,00	16,50	55720	57,69			55718	48,11			55719	52,93		
25,00	6,00	67,00	22,00	55724	99,11			55722	82,66			55723	90,92		

Ref. **9266**

FRESA ROTATIVA MD TIPO H LLAMA

Flame H Type HM Rotary Burr
Fraise lime rotative carbure type H flamma



MD
HM
Carbure

Tipo
H
Type

Norma
B
Norm

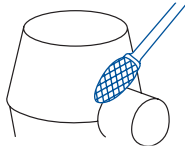
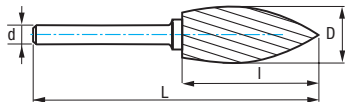

1
MAT. NO FERROSOS
Non-Ferrous Mat.
Mat. non ferreux



3
USO GENERAL
General Purpose
Utilisation Générale



4
VIRUTA CORTA
Short Chipping
Copeaux Courts



6
MATERIALES DUROS
Hard Materials
Matériaux Durs

Dentado		Dentado		Dentado		Dentado	
D	d	L	l	Teeth / Denture	Teeth / Denture	Teeth / Denture	Teeth / Denture
mm	mm	mm	mm	1	3	4	6
				Nº Art.	€	Nº Art.	€
3,00	3,00	38,00	6,00			44728	9,47
6,00	3,00	43,00	10,00			44729	15,53
6,00	6,00	50,00	14,00			44730	19,71
8,00	6,00	64,00	19,00	55791	29,87	44731	24,90
9,60	6,00	65,00	19,00	44726	35,65	44732	29,70
12,70	6,00	77,00	32,00	44727	43,12	44733	35,96
12,70	8,00	77,00	32,00			55792	53,21
16,00	6,00	81,00	36,00	44773	61,34	44734	51,13
16,00	8,00	81,00	36,00			55794	73,49
						44735	11,34
						44736	18,61
						44737	26,52
						44738	29,87
						44739	35,65
						44740	43,12
						44742	61,34
						44757	10,40
						44760	17,07
						44763	24,33
						44766	27,36
						44769	32,67
						44771	39,52
						55793	58,53
						44772	56,24
						55795	80,86

Ref. **9267**

FRESA ROTATIVA MD TIPO L CÓNICA REDONDEADA

Ball Nosed Cone L Type HM Rotary Burr
Fraise lime rotative carbure type L conique rayon



MD
HM
Carbure

Tipo
L
Type

Norma
KEL
Norm

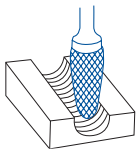
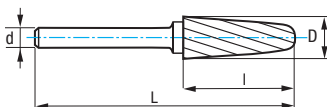

1
MAT. NO FERROSOS
Non-Ferrous Mat.
Mat. non ferreux



3
USO GENERAL
General Purpose
Utilisation Générale



4
VIRUTA CORTA
Short Chipping
Copeaux Courts



6
MATERIALES DUROS
Hard Materials
Matériaux Durs

Dentado		Dentado		Dentado		Dentado		Dentado		Dentado		
D	d	L	l	Ang.	Teeth / Denture	Teeth / Denture	Teeth / Denture	Teeth / Denture	Teeth / Denture	Teeth / Denture	Teeth / Denture	
mm	mm	mm	mm		1	1 ALTIN	3	4	6	6 ALTIN		
					Nº Art.	€	Nº Art.	€	Nº Art.	€	Nº Art.	€
3,00	3,00	38,00	14,00	10°	55806	13,29	44776	11,06	44783	13,29	44790	12,16
6,00	6,00	50,00	18,00	14°	55808	27,36	44778	22,81	44785	27,36	44792	25,07
6,30	3,00	48,00	15,80	22°	55807	20,72	44777	17,29	44784	20,72	44791	19,03
8,00	6,00	70,00	25,40	14°	55809	33,25	44779	27,66	44786	33,25	44793	30,40
10,00	6,00	65,00	20,00	14°	21959	39,82	44780	33,17	44787	39,82	44794	36,45
12,70	6,00	77,00	32,00	14°	44774	49,74	66508	60,84	44781	41,47	44788	49,74
12,70	8,00	77,00	32,00	14°	55812	46,54			55810	38,82		
16,00	6,00	78,00	33,00	14°	44775	74,63			44782	62,18	44789	74,63
16,00	8,00	78,00	33,00	14°	55815	91,59			55813	76,39		
									44795	45,60	20159	55,83
									55811	42,70		
									44796	68,42		
									55814	84,03		

Ref. **9268**

FRESA ROTATIVA MD TIPO F OJIVA REDONDEADA

Ball Nosed Tree F Type HM Rotary Burr
Fraise lime rotative carbure type F Ogive Rayon



MD HM Carbure	MD/HM + ALTiN	Tipo F Type	Norma RBF Norm
----------------------------	----------------------------	--------------------------	-----------------------------

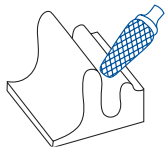
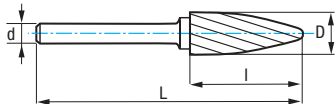

1
MATERIALES NO FERROSOS
Non-Ferrous Materials
Matériaux non ferreux



3
USO GENERAL
General Purpose
Utilisation Générale



4
VIRUTA CORTA
Short Chipping
Copeaux Courts



6
MATERIALES DUROS
Hard Materials
Matériaux Durs

D mm	d mm	L mm	l mm	Dentado Teeth / Denture 1		Dentado Teeth / Denture 1 ALTiN		Dentado Teeth / Denture 3		Dentado Teeth / Denture 4		Dentado Teeth / Denture 6		Dentado Teeth / Denture 6 ALTiN	
				Nº Art.	€	Nº Art.	€	Nº Art.	€	Nº Art.	€	Nº Art.	€	Nº Art.	€
3,00	3,00	38,00	14,00	55753	11,34			55750	9,47			17118	10,40	66503	16,20
6,00	6,00	50,00	18,00	55759	27,36			44797	22,81	44802	27,36	44808	25,07	66504	30,87
6,30	3,00	45,00	12,70	55758	18,61			55755	15,53			55756	17,07		
8,00	6,00	65,00	20,00	55760	33,17			44798	27,66	44803	33,17	44809	30,40		
9,60	6,00	64,00	19,00	55761	39,82	55880	41,71	44799	33,17	44804	39,82	44811	36,45	17250	38,27
12,70	6,00	70,00	25,00	55762	49,74	55881	57,29	44800	41,47	44805	49,74	44814	45,60	23849	52,58
12,70	8,00	70,00	25,00	55777	44,09			55774	36,77			55776	40,44		
16,00	6,00	70,00	25,00	55765	74,63			44801	62,18	44806	74,63	44817	68,42		
16,00	8,00	70,00	25,00	55782	60,87			55779	50,75			55780	55,84		
19,00	6,00	83,00	38,00	55771	118,32			55768	98,69			55769	108,53		

Ref. **9240**

FRESA ROTATIVA MD TIPO B LARGA

Long B Type HM Rotary Burr
Fraise lime rotative carbure type B longue



MD HM Carbure	Tipo B Type		Norma ZYA-S Norm
----------------------------	--------------------------	--	-------------------------------

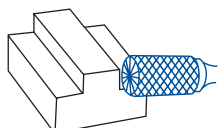
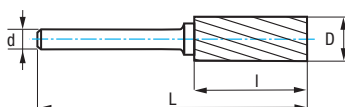

3
USO GENERAL
General Purpose
Utilisation Générale



6
MATERIALES DUROS
Hard Materials
Matériaux Durs



D mm	d mm	L mm	l mm	Dentado Teeth / Denture 3		Dentado Teeth / Denture 6	
				Nº Art.	€	Nº Art.	€
6,00	6,00	150,00	18,00	55832	73,04	55833	80,35
9,60	6,00	172,00	19,00	55834	48,96	55835	53,88
12,70	6,00	178,00	25,00	55836	69,31	55837	76,25

Ref. **9230**

FRESA ROTATIVA MD TIPO A LARGA

Long A Type HM Rotary Burr
Fraise Lime Rotative Carbure type A longue



MD
HM
Carbure

Tipo
A
Type



Norma
ZYA
Norm



MATERIALES DUROS
Hard Materials
Matériaux Durs

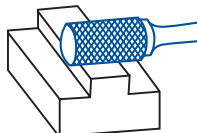
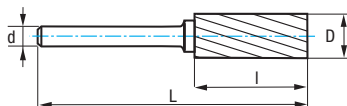

Dentado					
Teeth / Denture					
6					
N° Art.					
€					
6,00	6,00	150,00	18,00	55829	73,04
9,60	6,00	172,00	19,00	55830	48,96
12,70	6,00	178,00	25,00	55831	69,31

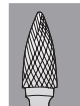

Ref. **9231**

FRESA ROTATIVA MD TIPO C RADIAL LARGA

Long Radial C Type HM Rotary Burr
Fraise lime rotative carbure type C hemisphérique longue



MD
HM
Carbure

Tipo
C
Type

Norma
WRC
Norm



MATERIALES DUROS
Hard Materials
Matériaux Durs

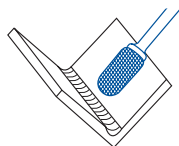
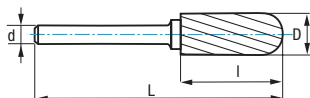

Dentado					
Teeth / Denture					
6					
N° Art.					
€					
6,00	6,00	150,00	18,00	55838	74,69
9,60	6,00	172,00	19,00	55839	45,96
12,70	6,00	178,00	25,00	55840	65,20



Ref. **9237**

FRESA ROTATIVA MD TIPO E GOTA LARGA

Long Oval E Type HM Rotary Burr
Fraise lime rotative carbure type E ovale longue



MD
HM
Carbure

Tipo
E
Type

Norma
TRE
Norm



3
USO GENERAL
General Purpose
Utilisation Générale



6
MATERIALES DUROS
Hard Materials
Matériaux Durs

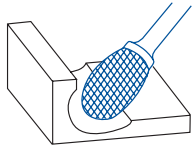
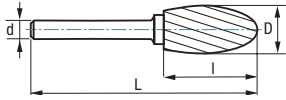

D mm	d mm	L mm	l mm	Dentado Teeth / Denture 3		Dentado Teeth / Denture 6	
				N° Art.	€	N° Art.	€
9,60	6,00	168,00	16,00	55849	42,04	55851	46,24
12,70	6,00	184,00	22,00	55852	52,15	55854	57,37

Ref. **9238**

FRESA ROTATIVA MD TIPO D ESFÉRICA LARGA

Long Ball D Type HM Rotary Burr
Fraise lime rotative carbure type D sphérique longue

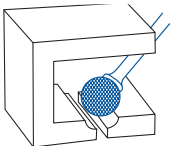
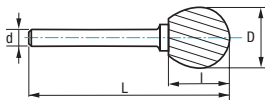

MD
HM
Carbure

Tipo
D
Type

Norma
KUD
Norm



3
USO GENERAL
General Purpose
Utilisation Générale



6
MATERIALES DUROS
Hard Materials
Matériaux Durs

D mm	d mm	L mm	l mm	Dentado Teeth / Denture 3		Dentado Teeth / Denture 6	
				N° Art.	€	N° Art.	€
8,00	6,00	182,00	6,00	55841	35,40	55842	38,93
9,60	6,00	170,00	8,00	55843	35,98	55845	39,58
12,70	6,00	175,00	11,00	55846	44,11	55848	48,52

Ref. **9247**

FRESA ROTATIVA MD TIPO L CÓNICA REDONDEADA LARGA

Long Ball Nosed Cone L Type HM Rotary Burr
Fraise lime rotative carbure type L conique rayon longue

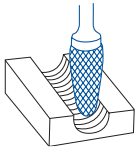
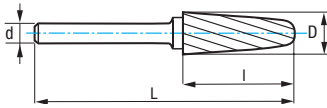

MD
HM
Carbure

Tipo
L
Type

Norma
KEL
Norm

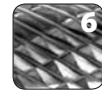

MATERIALES DUROS
Hard Materials
Matériaux Durs



					Dentado	
					Teeth / Denture	
D	d	L	l	Ang.	6	
mm	mm	mm	mm		Nº Art.	€
9,60	6,00	183,00	30,00	14°	55858	56,26
12,70	6,00	185,00	30,20	14°	55860	63,29

Ref. **9248**

FRESA ROTATIVA MD TIPO F OJIVA REDONDEADA LARGA

Long Ball Nosed Tree F Type HM Rotary Burr
Fraise lime rotative carbure type F ogive rayon longue

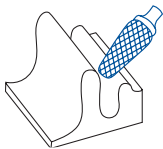
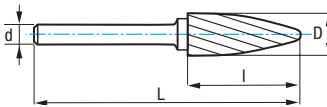

MD
HM
Carbure

Tipo
F
Type

Norma
RBF
Norm

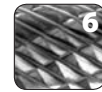

MATERIALES DUROS
Hard Materials
Matériaux Durs



					Dentado	
					Teeth / Denture	
D	d	L	l		6	
mm	mm	mm	mm		Nº Art.	€
9,60	6,00	172,00	19,00		55855	44,05
12,70	6,00	178,00	25,00		55857	57,55

Ref. **9200**

JUEGOS FRESAS ROTATIVAS MD

HM Rotary Burr Sets

Jeux fraises limes rotatives carbure



Mod. 1
Set 5 Pcs



MAT. NO FERROSOS
Non-Ferrous Mat.
Mat. non ferreux



MATERIALES DUROS
Hard Materials
Matériaux Durs

Cont. (1 x ref.)	D mm	d mm	Dentado Teeth / Denture 1		Dentado Teeth / Denture 6	
			Nº Art.	€	Nº Art.	€
9260						
9251	12,70	6,00	60052	215,07	45810	197,32
9255						
9258	9,60	6,00			68857	149,14
9266						



Mod. 2
Set 10 Pcs



MATERIALES DUROS
Hard Materials
Matériaux Durs

Cont. (1 x ref.)	D mm	d mm	Dentado Teeth / Denture 6	
			Nº Art.	€
9260				
9250				
9251				
9254				
9255	6,00	6,00	45811	218,92
9257				
9258				
9266				
9267				
9268				



Mod. 3
Set 8 Pcs



MATERIALES DUROS
Hard Materials
Matériaux Durs

Cont. (1 x ref.)	D mm	d mm	Dentado Teeth / Denture 6	
			Nº Art.	€
9260				
9250				
9251				
9254	3,00	3,00	45813	92,89
9257				
9258				
9267				
9268				



Mod. 4
Set 3 Pcs



MATERIALES DUROS
Hard Materials
Matériaux Durs

Cont. (1 x ref.)	D mm	d mm	Dentado Teeth / Denture 6	
			Nº Art.	€
9260				
9251	9,60	6,00	79826	94,98
9254				

Expo
9200

EXPOSITOR FRESAS ROTATIVAS

Rotary Burr Display

Présentoirs fraises limes rotatives carbure



Set 48 Pcs

Nº Art.	€
57079	1.509,78

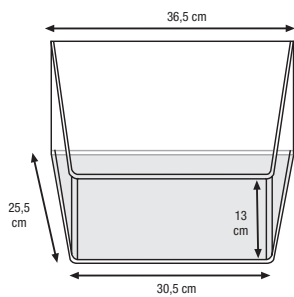

Dentado
Teeth / Denture

6

Ref.	Diam. mm	Nº Art.	€
9260	06,00X06,00	44141	2
	08,00X06,00	44142	2
	09,60X06,00	44143	2
	12,70X06,00	44144	2
9251	06,00X06,00	44438	2
	08,00X06,00	44439	2
	09,60X06,00	44440	2
	12,70X06,00	44441	2
9254	06,00X06,00	44488	2
	08,00X06,00	44494	2
	09,60X06,00	44500	2
	12,70X06,00	44512	2
9258	06,00X06,00	44721	2
	08,00X06,00	44722	2
	09,60X06,00	44723	2
	12,70X06,00	44724	2
9267	06,00X06,00	44792	2
	08,00X06,00	44793	2
	10,00X06,00	44794	2
	12,70X06,00	44795	2
9268	06,00X06,00	44808	2
	08,00X06,00	44809	2
	09,60X06,00	44811	2
	12,70X06,00	44814	2

Ref. **9674**

FRESA RANURADO ALUCOBOND / DIBOND

Alucobond / Dibond Sheet Bending End Mill
Fraise rainurage Alucobond/Dibond



MD
HM
Carbure

IZAR
Std.



12000-15000
rpm

Vf: 400-600
mm/min

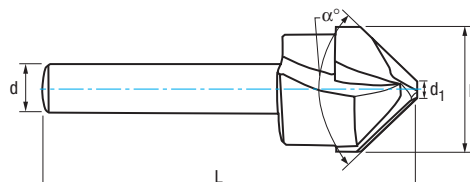

90°



2,5 mm

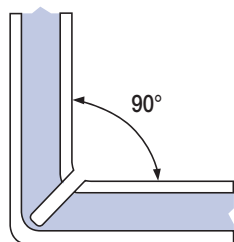
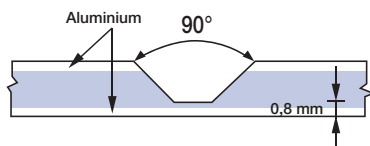

135°



2,3 mm

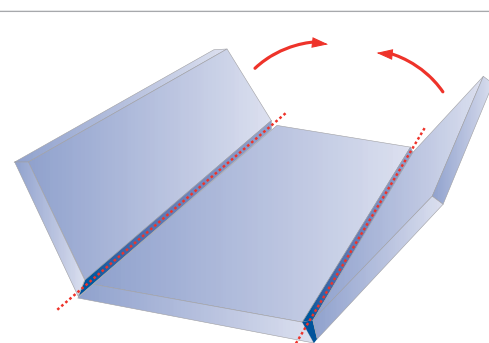
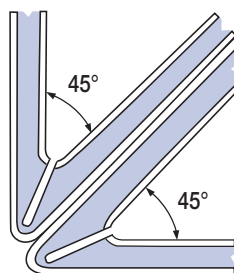
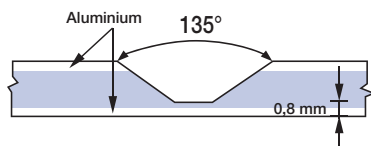

- Fresa especial para ranurados en Alucobond, Dibond, Durabond, Alupanel, Plexiglas, Alpolic, ACP, ACM...
- Se recomienda cortar casi hasta el fondo para poder doblar las planchas fácilmente.

- Special end mill for bending sheets of Alucobond, Dibond, Durabond, Alupanel, Plexiglas, Alpolic, ACP, ACM...
- The material should be cut almost until the bottom part leaving little amount of material left, that way the sheet will be bended easily.

- Fraise spécial pour rainurage sur Alucobond, Dibond, Durabond, Alupanel, Plexiglas, Alpolic, ACP, ACM...
- Il est recommandé de couper presque jusqu'au fond pour pouvoir plier les plaques facilement.

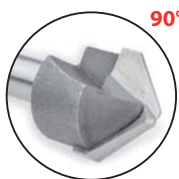

90°



135°

D mm	d mm	L mm	d ₁ mm	α °	N° Art.	€
α=90°						
16	8	59	2,5	90	81516	50,06
18	8	59	2,5	90	81519	50,77
20	8	59	2,5	90	81520	52,16

D mm	d mm	L mm	d ₁ mm	α °	N° Art.	€
α=135°						
16	8	59	2,3	135	81521	50,06
18	8	59	2,3	135	81522	50,77
20	8	59	2,3	135	81523	52,16

Ref. **9459**

FRESA 1Z GRABADO

1Z Engraving End Mill
Fraise 1Z gravure

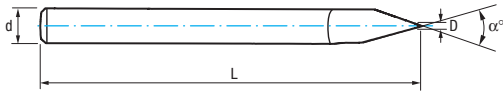

MD/HM/
Carbure
Micrograno

DIN
6535 HA

1Z

IZAR
std.

6000-
10000
r.p.m.

Aceros
<850 N/mm²
Steel / Aciers

Cobre
Copper
Cuivre

Aluminio
Aluminium

Plásticos
Plastics
Plastiques

Madera
Wood
Bois

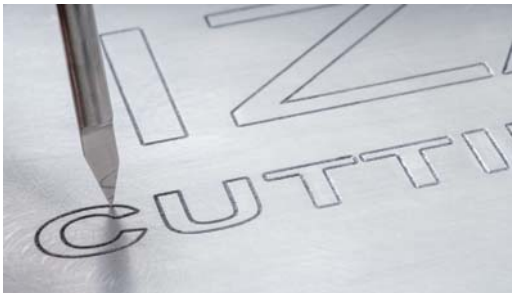

- **Afilado especial para grabado de metales, plásticos y maderas como: Aluminio, Cobre, Hierro, PVC, ABS, Metacrilato acrílico, Paneles bicolores, Madera MDF, etc.**
- **Specially designed geometry for engraving on Metal, Plastic and Wood. Valid for Aluminum, Copper, Iron, PVC, ABS, Acrylic, Bi-color panel, MDF fibreboard, etc.**
- **Géométrie spécial pour gravure de métaux, plastiques et bois telles que: Aluminium, cuivre, fer, PVC, ABS, méthacrylate acrylique, panneaux bicolores, bois MDF, etc.**

D	d	L	N°	€	D	d	L	N°	€	D	d	L	N°	€	D	d	L	N°	€
mm	mm	mm	Art.		mm	mm	mm	Art.		mm	mm	mm	Art.		mm	mm	mm	Art.	
α=30°					α=45°					α=60°					α=90°				
0,1	3,00	38	81048	8,54	0,1	3,00	38	81052	8,54	0,1	3,00	38	81055	8,54	0,1	3,00	38	81058	8,54
0,2	3,00	38	81049	8,54	0,2	3,00	38	81053	8,54	0,2	3,00	38	81056	8,54	0,2	3,00	38	81059	8,54
0,4	3,00	38	81050	8,54	0,2	4,00	45	81062	11,29	0,2	4,00	45	81065	11,29	0,2	4,00	45	81068	11,29
0,8	3,00	38	81051	8,54	0,2	6,00	50	81071	18,05	0,2	6,00	50	81080	18,05	0,2	6,00	50	81084	18,05
					0,4	3,00	38	81054	8,54	0,4	3,00	38	81057	8,54	0,4	3,00	38	81060	8,54
					0,4	4,00	45	81063	11,29	0,4	4,00	45	81066	11,29	0,4	4,00	45	81069	11,29
					0,4	6,00	50	81072	18,05	0,4	6,00	50	81081	18,05	0,4	6,00	50	81086	18,05
					0,8	4,00	45	81064	11,29	0,8	4,00	45	81067	11,29	0,8	4,00	45	81070	11,29
					0,8	6,00	50	81077	18,05	0,8	6,00	50	81082	18,05	0,8	6,00	50	81088	18,05
					2,0	6,00	50	81079	18,05	2,0	6,00	50	81083	18,05	2,0	6,00	50	81089	18,05

ALTIN bajo demanda / upon request / sur demande



Set 4 Pcs

Cont. D mm	N° Art.	€
0,1 mm 30°	81958	32,49
0,2 mm 30°		
0,4 mm 30°		
0,8 mm 30°		

Cont. D mm	N° Art.	€
0,1 mm 30°	81959	32,49
0,1 mm 45°		
0,1 mm 60°		
0,1 mm 90°		

Ref. **9419**

FRESA FRONTAL ACABADO METAL DURO 1Z ALTO RENDIMIENTO

High Performance 1Z HM Finishing End Mill
Fraise finition carbure 1Z haut rendement



MD/HM Carbure
Micrograno+

K10F
+
ALTIN

W



Tol.
D (h10)
d (h6)



Aluminio
Aluminium

Plásticos
Plastics
Plastiques

ALTIN
Mayor resistencia al desgaste
Higher Wear Resistance
Plus haute à l'usure



D mm	d mm	L mm	l mm	Z	Nº Art. MD/HM	€	Nº Art. ALTIN	€
3,00	3,00	38	12	1	58984	13,57	59195	20,79
4,00	4,00	40	15	1	58856	16,51	59196	23,62
5,00	5,00	50	16	1	58857	20,42	59197	27,33
6,00	6,00	50	18	1	58859	24,25	59198	30,98
8,00	8,00	63	22	1	58860	36,81	59199	44,17
10,00	10,00	72	30	1	58862	51,46	59201	57,96

Ref. **9411**

FRESA FRONTAL 1Z ALUMINIO METAL DURO

HM Aluminium 1Z End Mill
Fraise 1Z Aluminium carbure



MD/HM Carbure
Micrograno+

K10F
+
ALTIN

W



Tol.
D (h10)
d (h6)



Aluminio
Aluminium

Plásticos
Plastics
Plastiques

ALTIN
Mayor resistencia al desgaste
Higher Wear Resistance
Plus haute à l'usure



D mm	d mm	L mm	l mm	Z	Nº Art. MD/HM	€	Nº Art. ALTIN	€
3,00	3,00	38	12	1	13075	13,57	13114	20,79
4,00	4,00	40	12	1	13078	16,51	13123	23,62
5,00	5,00	50	12	1	13084	20,42	13126	27,33
6,00	6,00	50	14	1	13096	24,25	13135	30,98
8,00	8,00	63	15	1	13105	36,81	13138	44,17
10,00	10,00	72	15	1	13111	51,46	13144	57,96



Ref. **4412**

FRESA FRONTAL ACABADO HSS 1Z ALUMINIO

Aluminium 1Z HSS Finishing End Mill
Fraise finition HSS 1Z Aluminium



HSS	IZAR Std. W	Serie Corta Short Length Série courte	DIN 1835 A	d= 8-10 mm	Tol.* D (k10) d (h6)	* $\phi D = \phi d \Rightarrow$ Tol. D (js14) d (h6)
------------	-------------------	--	---------------	---------------	----------------------------	--

Aluminio Aluminium	Termoplásticos Thermoplastics Thermoplastiques
------------------------------	---

D mm	d mm	L mm	l mm	Z	Nº Art.	€
3,00	8	60	12	1	44087	12,00
4,00	8	60	12	1	44090	12,00
5,00	8	60	12	1	44093	12,00
6,00	8	60	14	1	44096	12,00
7,00	8	60	14	1	44099	14,66
8,00	8	80	15	1	44102	14,66
10,00	10	80	15	1	44105	15,08

Ref. **4414**

FRESA FRONTAL ACABADO HSS 1Z ALUMINIO

Aluminium 1Z HSS Finishing End Mill
Fraise finition HSS 1Z Aluminium



HSS	IZAR Std. W	Serie Larga Long Series Série longue	DIN 1835 A	d= 8-10 mm	Y	Tol.* D (k10) d (h6)	* $\phi D = \phi d \Rightarrow$ Tol. D (js14) d (h6)
------------	-------------------	---	---------------	---------------	---	----------------------------	--

Aluminio Aluminium	Termoplásticos Thermoplastics Thermoplastiques
------------------------------	---

D mm	d mm	L mm	l mm	Y mm	Z	Nº Art.	€
4,00	8	80	16	29	1	44120	16,96
5,00	8	80	16	29	1	44123	16,96
6,00	8	90	16	29	1	44126	16,96
8,00	8	100	28	40	1	44129	18,83
10,00	10	120	40	40	1	29178	19,40



HOJAS DE SIERRA DE CINTA

Band Saw Blades

Lames de scie à ruban

SELECCIÓN DE LA HOJA CORRECTA / Selecting the right Blade / Selection adaptée

1. Longitud de la Cinta (L)

La dimensión de la cinta depende únicamente de la máquina de corte empleada.

2. Ancho de la Cinta (A)

En las máquinas horizontales la anchura de la cinta es especificada por el fabricante.

Las máquinas verticales permiten mayores variaciones en la anchura de la cinta.

Sin embargo, la norma general es que cuanto más ancha es la hoja de sierra de cinta, mayor es su estabilidad.

Para el corte de contornos, el radio más pequeño a cortar limita el ancho de la cinta.

3. Espesor de la Cinta (E)

Cuanto más ancha es la hoja de sierra de cinta, mayor es su espesor.

4. Dentado (TPI)

El dentado es el nº de dientes por pulgada (25,4 mm).

Los dentados se diferencian en constantes, paso de diente uniforme, y variables, con diferente paso de diente dentro de cada intervalo.

Los dentados variables se definen con dos medidas, p.e. 2-3 TPI: 2 TPI significa el paso de diente máximo, y 3 TPI significa el paso de diente mínimo en el intervalo de dentado.

Aquí, la longitud de contacto de la sierra de cinta con la pieza a cortar es decisiva.

5. Forma Diente (TZ)

Diente estándar (S)

Angulo desprendimiento 0°:

- materiales de viruta corta
- aceros de alto contenido en carbono
- preferiblemente acero de herramienta y hierro fundido
- materiales de poca sección de corte
- perfiles de pared delgada

Diente de garra (K)

Angulo de desprendimiento positivo para macizos:

- empleo universal
- metales no ferrosos y aceros con un contenido en carbono de < 0,8%
- aceros estructurales, aceros para extrusión en frío y aceros templados

1. Band Length (L)

The band dimension individually depends on the used cutting machine.

2. Band Width (A)

With horizontal machines the band width is specified by the manufacturer.

Vertical band saw machines allow higher variations of the band width.

However, the general rule is the wider the band saw blade the higher its stability.

In case of contour cuts the smallest radius to be cut is the limiting factor for the band width.

3. Band Thickness (E)

The wider the band saw blade the higher its thickness.

4. Tooth pitch (TPI)

Tooth pitch is the number of teeth per inch (25,4 mm).

A difference is made between constant tooth pitches with regular tooth distance and variable tooth pitches with differing tooth distance within one interval.

Variable tooth pitches are marked by two measures, e.g. 2-3 TPI: 2 TPI signifies the maximum tooth distance and 3 TPI signifies the minimum tooth distance in the toothing interval.

Here the contact length of the blade in the work piece is decisive.

5. Tooth Shape (TZ)

Raker tooth (S)

0° rake angle for:

- short-chipping materials
- steels with high carbon content
- preferably tool steel and cast iron
- materials with small cross-sections
- thin-walled profiles

Hook tooth (K)

Positive rake angle for solids:

- universal use
- non-ferrous metals and steels with a carbon content of < 0,8%
- structural steels, steels for cold extrusion, tempered steels

1. Longueur de Lame (L)

La dimension d'une lame dépend de la machine utilisée.

2. Largeur de la Lame (A)

Sur des machines horizontales, la largeur de la lame est spécifiée par le fabricant.

Les machines verticales permettent de plus grandes variations dans les largeurs de lames.

La règle est généralement la suivante: Plus la lame est large, plus la rigidité est importante.

En cas de contournage, la largeur du ruban est limitée par le plus petit rayon à scier.

3. Epaisseur de Lame (E)

Plus la lame est large, plus la épaisseur est importante.

4. Dentures (TPI)

La denture est au nº de dents par pouce (25,4 mm).

Une différence réside entre les dentures constantes, où l'écart entre deux pointes de dents reste égal et les dentures variables, où les valeurs des pas de dents sont différentes.

La denture variable est caractérisée par deux chiffres, p.e. 2-3 TPI: 2 TPI désigne l'écart maxi entre les dents et le chiffre 3 TPI l'écart mini entre les dents sur une séquence de denture.

La surface de contact de la lame sur la pièce à débiter est décisive.

5. Forme de Dent (TZ)

Dent standard (S)

Angle de coupe 0° pour:

- matériaux à copeaux courts
- aciers à forte teneur en carbone
- les fontes et aciers à outil
- pièces de petites sections
- profils à parois minces

Dent griffe (K)

Angle de coupe positif pour matériaux pleins:

- usage universel
- métaux non ferreux et aciers à teneur en carbone de < 0,8%
- aciers de construction, aciers pour extrusion à froid et aciers trempés

Ancho cinta y radio más pequeño Band widths and smallest radius Largeurs de lames et plus petit rayon

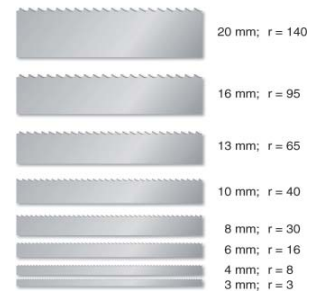

Dentado constante Constant tooth pitch Denture constante



Dentado variable Variable tooth pitch Denture variable



Tabla selección dentado

Tooth selection table

Tableau sélection denture

Dentado Tooth Denture	Perfil Profile Profil	Macizo Solid Plein
10 / 14	0-1 mm	0-10 mm
8 / 12	1-2,5 mm	10-20 mm
6 / 10	2,5-5 mm	20-40 mm
5 / 8	5-7 mm	40-50 mm
4 / 6	7-10 mm	50-90 mm
3 / 4	>10 mm	90-120 mm
2 / 3		>120 mm
1,4 / 2		>250 mm

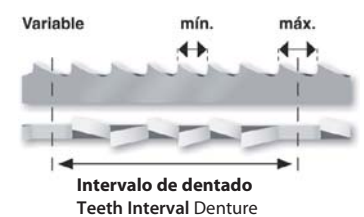
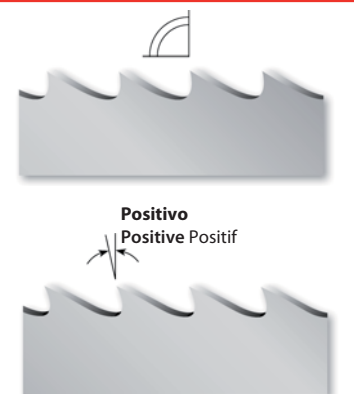

Ref. **4223**

HOJA DE SIERRA DE CINTA HSSE 8% Co IZARFLEX

IZARFLEX HSSE 8% Co Band Saw Blade

Lame de scie à ruban HSSE 8% Co IZARFLEX

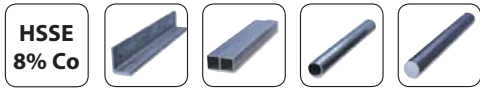
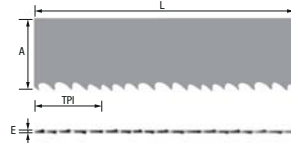

Aceros
<850 N/mm²
Steel / Aciers

Aceros
<1000 N/mm²
Steel / Aciers

Cobre
Copper
Cuivre

Aluminio
Aluminium

Plásticos
Plastics
Plastiques

Ideal para trabajos de taller exigentes, con los dientes de una calidad especial resistente al desgaste. Fleje flexible, bimetálico, combina dentados 0 y +

Ideal for heavy duty workshop cutting tasks, with special wear resistant quality teeth. Flexible strip, bimetal, 0 & + teeth combined.

Idéal pour des travaux d'atelier exigeants, avec dents d'une qualité spéciale résistante à l'usure. Feuillard Flexible, bimétal, possibilité dentures 0 et +

New!						New!						New!						New!					
L	A	E	€	mm	1 ud.	L	A	E	€	mm	1 ud.	L	A	E	€	mm	1 ud.	L	A	E	€	mm	1 ud.
1030	13	0,65	3	17,49		1875	13	0,65	3	27,88		2100	20	0,90	2	34,16		2060	27	0,90	2	34,23	
1080				18,34		2120				28,65		2110				34,31		2070				34,41	
1104				18,74		2125				28,72		2115				34,39		2080				34,55	
1115				18,93		2150				29,05		2120				34,47		2085				34,64	
1125				19,10		2230				30,14		2130				34,60		2090				34,81	
1130				19,21		2240				30,25		2140				34,72		2100				34,93	
1138				19,31		2242				30,29		2215				35,57		2110				35,04	
1140				19,36		2390				31,48		2225				35,72		2140				35,38	
1270				20,39		2440				32,15		2240				35,98		2145				35,46	
1300				20,87		2490				32,81		2265				36,36		2150				35,53	
1310				20,96		2500				32,94		2300				36,93		2155				35,64	
1325				21,08		2550				33,59		2355				37,55		2360				38,26	
1328				21,10		2560				33,69		2360				37,62		2375				38,49	
1330				21,13		2580				33,99		2362				37,64		2400				38,89	
1335				21,15		2650				34,58		2365				37,70		2410				39,05	
1340				21,21		2735				35,30		2370				37,77		2440				39,53	
1350				21,35		2800				35,97		2375				37,82		2445				39,61	
1365				21,42		2840				36,45		2380				37,92		2448				39,66	
1385				21,59		2845				36,52		2400				38,22		2450				39,69	
1400				21,83		2890				37,13		2450				38,77		2455				39,76	
1410				22,38		2900				37,24		2465				39,01		2459				39,81	
1425				22,22		3115				39,39		2470				39,09		2460				39,82	
1435				22,38		3140				39,67		2480				39,25		2465				39,90	
1440				22,46		3160				39,89		2490				39,41		2470				39,97	
1445				22,52		3200				40,31		2520				39,73		2480				40,10	
1450				22,58		3355				41,99		2530				39,87		2485				40,18	
1460				23,14		3370				42,17		2540				40,03		2500				40,44	
1470				23,70		3430				42,93		2542				40,06		2515				40,68	
1480				23,71		3590				44,93		2560				40,34		2520				40,76	
1490				23,87		3600				45,06		2600				40,98		2535				40,86	
1514				23,97		3830				47,05		2610				41,13		2540				40,89	
1525				24,01		3857				47,38		2625				41,37		2550				41,06	
1550				24,14		4100				48,77		2630				41,45		2560				41,20	
1575				24,26		4180				49,72		2650				41,76		2565				41,28	
1580				24,30		4400				52,23		2665				42,01		2570				41,35	
1600				24,41		4440				52,64		2710				42,72		2580				41,50	
1620				24,52		4600				54,59		2750				43,34		2590				41,64	
1630				24,56		5140				61,00		2770				43,65		2600				41,76	
1635				24,66		1350	20	0,90	2	23,31		2950				44,59		2615				42,01	
1638				24,70		1710				28,10		2970				44,71		2625				42,17	
1640				24,72		1735				28,50		2980				44,77		2655				42,38	
1645				24,78		1740				28,59		3000				44,88		2660				42,45	
1650				24,86		1750				28,75		3084				45,28		2680				42,89	
1660				25,03		2000				30,85		3240				46,13		2700				43,15	
1710				25,42		2005				31,76		3280				46,70		2710				43,32	
1715				25,49		2010				32,67		3454				48,78		2715				43,40	
1718				25,54		2020				32,82		3950				54,26		2720				43,49	
1730				25,72		2035				33,22		3960				54,66		2725				43,56	
1735				25,79		2037				33,28		4000				55,21		2730				43,63	
1740				25,86		2040				33,32		4185				57,48		2735				43,71	
1745				25,95		2058				33,64		4270				58,65		2740				43,79	
1750				26,02		2060				33,66		4400				60,44		2750				43,84	
1770				26,33		2065				33,72		4485				61,61		2755				43,92	
1790				26,62		2070				33,77		4700				64,55		2759				45,90	
1838				27,33		2075				33,85		4900				67,30		2760				43,98	
1840				27,35		2080				33,92		5130				70,47		2765				44,04	
1845				27,43		2085				33,97		5800				76,43		2770				44,13	
						2090				34,05		7220				99,17							
						2095				34,11		7320				100,54							

Ref. **4223**

HOJA DE SIERRA DE CINTA HSSE 8% Co IZARFLEX

IZARFLEX HSSE 8% Co Band Saw Blade

Lame de scie à ruban HSSE 8% Co IZARFLEX

New!

L mm	A mm	E mm		€ 1 ud.
2795	27	0,90	2	44,40
2800				44,48
2810				44,65
2820				44,81
2825				44,88
2830				44,95
2835				45,03
2840				45,09
2845				45,17
2847				45,21
2850				45,26
2855				45,34
2860				45,41
2865				45,46
2870				45,51
2880				45,59
2884				45,65
2890				45,73
2900				45,88
2910				46,07
2915				46,12
2920				46,19
2925				46,27
2927				46,30
2940				46,44
2945				46,52
2950				46,62
2960				46,77
2964				46,84
2965				46,85
2985				47,05
3000				47,30
3010				47,46
3015				47,53
3020				47,59
3025				47,68
3035				47,85
3050				48,08
3084				48,42
3090				48,54
3100				48,71
3110				48,83
3120				48,99
3140				49,24
3150				49,39
3160				49,54
3175				49,75
3180				49,83
3200				50,14
3215				50,36
3220				50,45
3230				50,60
3250				50,91
3270				51,03
3280				51,09
3285				51,12
3300				51,35
3310				51,49
3320				51,65
3345				52,05
3350				52,13
3352				52,16
3365				52,37
3370				52,45
3378				52,57
3380				52,59
3400				52,86
3420				53,13
3430				53,27
3435				53,35

New!

L mm	A mm	E mm		€ 1 ud.
3440	27	0,90	2	53,43
3460				53,59
3490				53,88
3495				53,92
3500				54,00
3505				54,07
3550				54,77
3560				54,93
3600				55,54
3630				56,00
3640				56,15
3650				56,31
3660				56,47
3667				56,57
3670				56,62
3700				57,09
3800				58,40
3810				58,55
3820				58,70
3830				58,85
3850				59,16
3851				59,18
3853				59,20
3900				59,93
3930				60,39
3950				60,69
4000				61,46
4038				61,85
4050				61,96
4079				62,24
4090				62,41
4100				62,56
4115				62,79
4150				62,97
4240				63,41
4250				63,46
4270				63,56
4310				63,75
4470				64,52
4500				64,88
4590				66,18
4600				66,32
4870				69,76
4875				69,82
4900				70,18
4960				70,95
5000				71,45
5035				71,94
5060				72,30
5090				72,68
5430				77,18
5445				77,39
5600				82,10
5725				83,93
6200				89,14
6500				93,44
7400				103,18

New!

L mm	A mm	E mm		€ 1 ud.
2600	34	1,10	1	47,93
2620				48,29
2630				48,47
2970				54,74
3505				64,33
3530				64,80
3634				66,71
3655				67,09
3660				67,18
3730				68,47
3770				69,20
3780				69,38
3800				69,75
3820				70,12
3830				70,30
3840				70,48
3851				70,68
3870				71,03
3920				71,49
4020				72,65
4030				72,83
4100				74,10
4115				74,34
4120				74,41
4130				74,60
4160				75,14
4180				75,50
4200				75,86
4250				76,77
4260				76,95
4300				77,68
4335				77,95
4340				78,04
4350				78,22
4370				78,59
4380				78,77
4400				79,13
4420				79,47
4440				79,84
4470				80,38
4520				80,90
4570				81,78
4600				82,32
4610				82,50
4640				83,04
4670				83,58
4720				84,28
4750				84,69
4770				85,04
4780				85,23
4800				85,58
4900				87,08
4930				87,61
4970				88,34

New!

L mm	A mm	E mm		€ 1 ud.
4990	34	1,10	1	88,70
5000				88,87
5070				90,09
5080				90,27
5090				90,44
5150				91,34
5200				92,11
5270				93,35
5320				94,24
5400				95,65
5500				97,41
5600				99,19
5700				100,98
5720				101,33
5800				102,74
6000				103,77
6060				104,81
6340				105,54
6350				105,72
6360				105,90
7000				115,87
7002				115,88
7010				116,04
8730				144,51
4115	41	1,30	1	106,08
4500				116,01
4570				117,81
4650				119,21
4670				119,73
4800				122,57
4930				125,40
5000				127,17
5090				129,46
5200				132,26
5334				135,67
5400				137,35
5450				138,61
5500				139,89
5600				142,43
5700				144,28
5800				146,12
5920				149,15
5940				149,65
6192				156,02
6500				161,97
6600				164,45
6675				166,32
6775				168,81
6800				169,43
6990				174,18
7250				180,53
7400				184,27
7470				186,02
7880				196,23

Tipo Dentado (TZ) / Teeth Type (TZ) / Type Denture (TZ)

A x E	TPI									
	2	2-3	3	3-4	4	4-6	5-8	6-10	8-12	10-14
13 x 0,65								S	S	S
20 x 0,90			K		K	K	S	S	S	S
27 x 0,90	K		K	K	K	K	S	S	S	S
34 x 1,10		K	K	K		K	S	S	S	
41 x 1,30			K		K					



Unidades pedido mínimo
Minimum order units
Unités commande minimale

Rollos sin Soldadura Rolls without Welding Rouleaux non soudés

L mm	A mm	E mm	8% Co €
30500	13	0,65	329,09
100000	20	0,90	1.184,72
100000	27	0,90	1.259,81
100000	34	1,10	1.489,25
75000	41	1,30	1.626,92

Ejemplo Pedido / Order Example / Exemple Commande Ref. 4223 + L 2450 + A 27 + E 0,90 + TPI 6-10 + TZ S

Ref. **4228**

HOJA DE SIERRA DE CINTA HSSE 8% Co + 4% Cr IZARPLUS

IZARPLUS HSSE 8% Co + 4% Cr Band Saw Blade

Lame de scie à ruban HSSE 8% Co + 4% Cr IZARPLUS

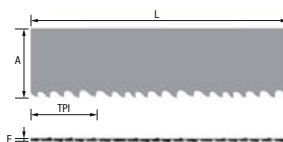

Aceros <850 N/mm ² Steel / Aciers	Aceros <1000 N/mm ² Steel / Aciers	Fundición Cast Iron Fonte	INOX Stainless Steel Acier INOX
Cobre Copper Cuivre	Aluminio Aluminium	Plásticos Plastics Plastiques	

Especial Perfiles. Dentado variable 0° adecuado para perfiles y tareas de corte en serie, susceptibles de vibraciones.

Special Profiles. Variable tooth pitch 0° for profiles and bundle sawing tasks, susceptible of vibrations.

Spécial profils. Denture variable 0° convenable pour profils et travaux de coupe en paquet, susceptibles des vibrations.

New!

L	A	E	€
mm	mm	mm	1 ud.
1100	13	0,65	23,88
1130			24,53
1138			24,71
1140			24,74
1300			27,21
1310			27,42
1325			27,58
1330			27,71
1335			27,79
1340			27,90
1350			28,09
1368			28,46
1400			28,81
1425			29,13
1430			29,17
1435			29,30
1440			29,39
1450			30,18
1460			30,39
1470			30,59
1500			30,94
1550			31,55
1575			32,05
1580			32,16
1605			32,29
1620			32,35
1635			32,41
1638			32,46
1640			32,49
1645			32,60
1650			32,70
1680			33,29
1730			33,87
1732			33,91
1735			33,96
1740			34,02
1750			34,19
1974			38,57
2180			42,56
2240			43,73
2265			44,23
2900			56,61
3700			66,88
3800			68,68
3825			69,13
4180			73,02

New!

L	A	E	€
mm	mm	mm	1 ud.
1125	13	0,90	24,42
1140			24,74
1325			27,58
1330			27,70
1335			27,79
1338			27,85
1375			28,60
1470			30,59
1485			30,90
1638			32,46
1640			32,48
1650			32,70
1735			33,96
1750			34,19
1840			35,97
2240			43,73

New!

L	A	E	€
mm	mm	mm	1 ud.
1735	20	0,90	33,96
2000			36,42
2010			36,60
2035			36,87
2045			37,05
2060			37,33
2070			37,48
2080			37,63
2082			37,65
2085			37,71
2090			37,79
2100			37,95
2110			38,10
2130			38,37
2140			38,56
2150			38,73
2265			40,45
2360			41,87
2362			41,92
2370			42,03
2375			42,09
2400			42,47
2465			43,46
2480			43,73
2500			43,99
2520			44,27
2530			44,44
2600			45,68
2825			48,43
2960			50,75
2970			50,92
2980			51,09
3000			51,43

New!

L	A	E	€
mm	mm	mm	1 ud.
2080	27	0,90	42,50
2100			42,53
2110			42,54
2145			42,60
2150			42,60
2190			43,39
2360			43,09
2375			43,10
2400			43,13
2430			43,17
2435			43,18
2440			43,18
2445			43,20
2450			43,29
2455			43,32
2460			43,34
2470			43,91
2480			44,46
2490			44,51
2500			44,54
2520			44,59
2535			44,66
2550			44,72
2560			44,84
2565			44,89
2570			44,99
2600			45,47
2640			45,73
2655			45,82
2660			45,91
2680			46,26
2700			47,00
2710			47,18
2715			47,18
2720			47,18
2730			47,22
2740			47,24
2745			47,28
2750			47,32
2755			47,42
2760			47,48
2765			47,53
2780			47,78
2800			48,03
2805			48,11
2820			48,36
2825			48,43

Ref. **4228**

HOJA DE SIERRA DE CINTA HSSE 8% Co + 4% Cr IZARPLUS

IZARPLUS HSSE 8% Co + 4% Cr Band Saw Blade

Lame de scie à ruban HSSE 8% Co + 4% Cr IZARPLUS

New!					New!					New!									
L	A	E	€	1 ud.	L	A	E	€	1 ud.	L	A	E	€	1 ud.	L	A	E	€	1 ud.
mm	mm	mm			mm	mm	mm			mm	mm	mm			mm	mm	mm		
2830	27	0,90	2	48,48	3352	27	0,90	2	55,93	3320	34	1,10	1	73,03	4115	41	1,30	1	124,55
2835				48,50	3370				56,23	3505				77,10	4500				135,14
2840				48,51	3400				57,36	3660				79,38	4640				139,35
2845				48,52	3420				57,47	3730				80,91	4930				147,33
2850				48,59	3440				57,80	3770				81,78	5000				149,42
2860				48,59	3454				58,05	3800				82,43	5040				150,62
2865				48,60	3485				58,07	3820				82,85	5090				152,10
2870				48,60	3505				58,08	3860				83,72	5265				156,94
2885				48,61	3560				58,50	3920				84,98	5300				158,00
2900				48,61	3630				58,78	3950				85,64	5340				159,20
2910				48,78	3650				59,08	4020				87,15	5350				159,50
2920				48,89	3660				59,24	4030				87,37	5450				162,17
2925				49,00	3670				59,41	4100				88,89	5700				168,88
2927				49,03	3800				60,20	4120				89,34	5920				175,41
2950				49,37	3810				60,37	4160				90,21	6175				182,96
2965				49,64	3820				60,52	4250				91,74	6300				186,15
3000				50,25	3830				60,66	4335				93,59	6400				189,10
3010				50,41	3835				60,75	4380				94,58	6585				194,16
3025				50,67	3850				60,99	4400				95,01	6775				199,50
3035				50,84	3851				61,00	4420				95,44	6800				200,23
3080				53,27	3857				61,11	4450				95,86	6900				203,03
3090				53,45	3900				61,79	4470				96,29	7470				219,08
3100				53,61	3930				62,26	4500				96,87	7880				231,11
3110				53,64	4090				64,36	4520				97,26	8200				240,49
3120				53,67	4115				64,76	4570				98,25					
3135				53,71	4160				65,46	4610				98,99					
3140				53,72	4230				66,55	4620				99,22					
3150				53,74	4250				66,86	4640				99,64					
3160				53,77	4280				67,35	4780				102,43					
3180				53,82	4500				70,81	4800				102,86					
3200				54,16	4600				72,39	4930				105,33					
3270				54,56	4820				80,90	4970				106,19					
3300				55,06	4870				81,73	4990				106,58					
3320				55,39	4880				81,90	5040				107,51					
3335				55,65	5030				84,42	5050				107,72					
3340				55,72	5200				87,28	5080				108,25					
3345				55,82						5090				108,42					
3350				55,89						5200				110,76					
										5270				112,15					
										5300				112,74					
										6350				127,21					
										6500				130,02					
										6550				131,02					
										7000				139,52					
										7550				149,89					
										8730				173,32					

Tipo Dentado (TZ) / Teeth Type (TZ) / Type Denture (TZ)

A x E	TPI					
	3-4	4-6	5-8	6-10	8-12	10-14
13 x 0,65				S	S	S
13 x 0,90				S	S	S
20 x 0,90		S	S	S	S	S
27 x 0,90	S	S	S	S	S	S
34 x 1,10	S	S	S	S	S	
41 x 1,30	S	S	S	S		

Rollos sin Soldadura / Rolls without Welding / Rouleaux non soudées

L	A	E	8% Co	L	A	E	8% Co
mm	mm	mm	€	mm	mm	mm	€
30500	13	0,65	413,62	100000	27	0,90	1.469,64
123000			1.666,73	134000			2.023,02
30500	13	0,90	413,62	100000	34	1,10	1.804,64
100000	20	0,90	1.414,06	75000	41	1,30	1.921,33

 Unidades pedido mínimo
Minimum order units
Unités commande minimale

Ejemplo Pedido / Order Example / Exemple Commande

Ref. 4228 + L 2080 + A 27 + E 0,90 + TPI 8-12 + TZ S

Ref. **4229**

HOJA DE SIERRA DE CINTA HSSE 8% Co + 4% Cr IZARPLUS

IZARPLUS HSSE 8% Co + 4% Cr Band Saw Blade

Lame de scie à ruban HSSE 8% Co + 4% Cr IZARPLUS

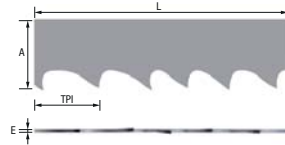

**HSSE
8% Co**

4% Cr



**Aceros
<850 N/mm²
Steel / Aciers**

**Aceros
<1000 N/mm²
Steel / Aciers**

**INOX
Stainless Steel
Acier INOX**

**Cobre
Copper
Cuivre**

**Aluminio
Aluminium**

**Plásticos
Plastics
Plastiques**

Especial Macizos. Dentado variable 10°. Mayores rendimientos de corte, ideal para el corte de piezas macizas grandes.

Special Solid Pieces. Variable tooth pitch 10°. Higher cutting performance, suitable to cut big solid pieces.

Spécial pièces pleins. Denture variable 10°. Rendements de coupe supérieurs, convenable pour la coupe de grandes pièces pleins.

New!

L mm	A mm	E mm		€ 1 ud.
2080	27	0,90	2	42,50
2150				42,61
2450				43,29
2455				43,31
2459				43,33
2460				43,34
2480				44,46
2550				44,72
2565				44,92
2570				44,99
2590				45,30
2600				45,47
2680				46,26
2700				47,00
2710				47,18
2720				47,23
2740				47,30
2750				47,32
2755				47,42
2760				47,48
2765				47,53
2800				48,01
2825				48,43
2835				48,48
2845				48,52
2855				48,69
2910				48,78
2925				49,00
2950				49,37
3000				50,25
3010				50,41
3025				50,67
3035				50,84
3100				53,61
3105				53,63
3120				53,68
3140				53,73

New!

L mm	A mm	E mm		€ 1 ud.
3150	27	0,90	2	53,74
3160				53,76
3180				53,82
3200				54,19
3222				54,54
3240				54,84
3270				54,95
3300				55,06
3320				55,39
3345				55,82
3350				55,89
3352				55,93
3400				57,12
3420				57,47
3445				57,89
3495				58,56
3500				58,64
3505				58,73
3520				58,78
3550				58,89
3640				59,18
3660				59,24
3770				59,74
3800				60,20
3810				60,36
3820				60,52
3830				60,67
3900				61,79
3930				62,26
4090				64,36
4110				64,68
4115				64,76
4310				70,85
4500				73,73
4800				78,64

New!

L mm	A mm	E mm		€ 1 ud.
3350	34	1,10	1	70,51
3505				77,10
3770				81,77
3820				82,85
3850				83,50
4020				87,19
4100				88,92
4115				89,22
4120				89,33
4130				89,55
4160				90,20
4210				91,28
4220				91,50
4250				92,14
4335				93,59
4420				95,10
4440				95,54
4450				95,75
4470				96,18
4500				96,83
4520				97,27
4530				97,47
4570				98,25
4640				99,77
4720				101,13
4770				102,19
4780				102,43
4860				104,15
4865				104,23
4970				106,19
4990				106,58
5000				106,82
5090				108,73
5156				109,83
5200				110,76
5270				112,11
5300				112,74

New!

L mm	A mm	E mm		€ 1 ud.
4115	41	1,30	1	124,55
4500				135,14
4640				139,35
4650				139,63
4700				141,14
4900				146,44
4930				147,33
5000				149,40
5040				150,60
5080				151,80
5090				152,10
5340				159,20
5350				159,50
5450				162,47
5800				172,03
5890				174,53
5920				175,41
6300				185,75
6500				191,65
6585				194,16
6675				196,81
6775				199,50
6800				200,23
6900				203,02
7470				219,08
8200				228,23
8400				233,70
5800	54	1,60	1	212,61
6040				225,22
6096				227,31
6200				233,60
6270				236,10
6500				244,28
7140				267,12
7200				269,25
7310				273,36
7450				278,11
7460				278,48
7545				281,45
7600				283,50
8900				339,68
9750				372,12

Tipo Dentado (TZ) / Teeth Type (TZ) / Type Denture (TZ)

A x E	TPI				
	1,4-2	2-3	3-4	4-6	5-8
27 x 0,90		K	K	K	K
34 x 1,10	K	K	K	K	K
41 x 1,30	K	K	K	K	K
54 x 1,60	K	K	K	K	



Unidades pedido mínimo
Minimum order units
Unités commande minimale

Rollos sin Soldadura
Rolls without Welding - Rouleaux non soudées

L mm	A mm	E mm	8% Co €
100000	20	0,90	1.414,06
100000	27	0,90	1.469,64
134000			2.023,02
100000	34	1,10	1.804,64
75000	41	1,30	1.921,41

Ejemplo Pedido / Order Example / Exemple Commande

Ref. 4229 + L 2080 + A 27 + E 0,90 + TPI 5-8 + TZ K

Ref. **1994**

ARCO SIERRA

Hacksaw Frame
Monture scie

¡Hoja de Sierra de Regalo!

Free Hacksaw Blade!

Lame scie cadeau!



Arco ergonómico de aleación de aluminio. Corte recto, vertical y horizontal. Hoja sierra regalo art. 67592: TPI 24

Ergonomic Aluminium alloyed hack saw frame. Straight cut, both vertical and horizontal. Free hacksaw blade art. 67592: TPI 24

Monture ergonomique de alliage aluminium. Coupe droite et horizontale. Lame scie cadeau art. 67592 : TPI 24



Nº Art.	€
62289	10,25



Ref. **1999**

HOJA SIERRA

Hacksaw Blade
Lame scie

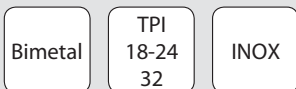

Aceros <850 N/mm ² Steel / Aciers	Aceros <1000 N/mm ² Steel / Aciers
INOX Stainless Steel Acier INOX	

	TPI	L mm	📦	Nº Art.	€ 1 ud.
New!	18	300	20	48809	1,77
	18	300	100	13856	1,55
	24	300	20	25355	1,77
	24	300	100	25387	1,55
	32	300	100	28767	1,55



Ref. **1997**

HOJA SIERRA

Hacksaw Blade
Lame scie

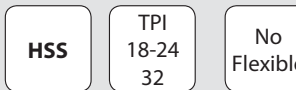

Aceros <850 N/mm ² Steel / Aciers	Aceros <1000 N/mm ² Steel / Aciers
--	---

	TPI	L mm	📦	Nº Art.	€ 1 ud.
New!	18	300	20	48806	1,54
	18	300	100	34553	1,31
	24	300	20	34552	1,54
	24	300	100	34554	1,31
	32	300	100	34555	1,31



Ref. **1996**

HOJA SIERRA

Hacksaw Blade
Lame scie



Mod.
1



Mod.
2



Mod.	Uso / Use / Usage	TPI	L mm	📦	Nº Art.	€ 1 ud.
1	Metal	24	300	50	17139	1,05
2	Metal-Madera/Wood/Bois	24	300	50	67592	0,58



HERRAMIENTAS TORNEADO

Brazed Turning Tools

Outils de tour

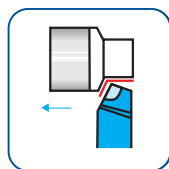
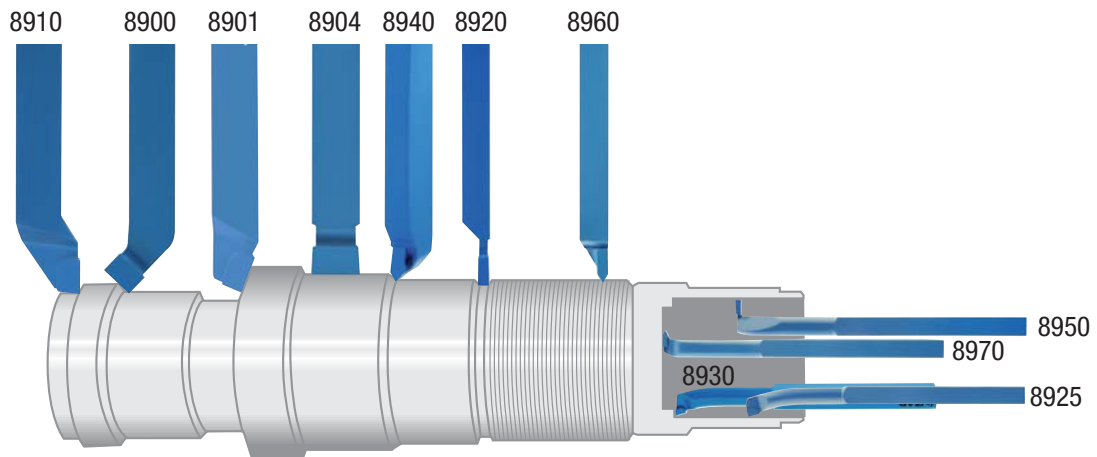

ISO 1 - 8901

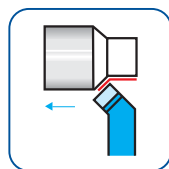

ISO 2 - 8900

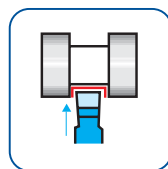

ISO 4 - 8904

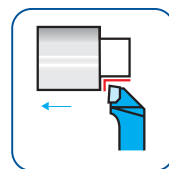

ISO 6 - 8910

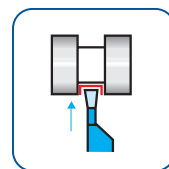

ISO 7 - 8920

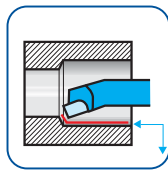

ISO 8 - 8925

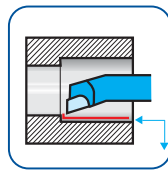

ISO 9 - 8930

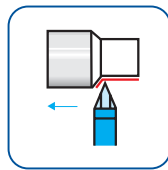

ISO 10 - 8940

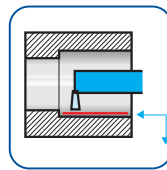

ISO 11 - 8950

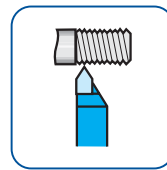

ISO 12 - 8960

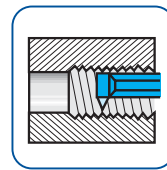

ISO 13 - 8970

Calidad P20

Especialmente destinada a mecanizados de gran precisión y semi-acabado en aceros al carbono y aleados, a grandes velocidades de corte y avances moderados.

P20 Quality

Specially destined for high precision and semi-finishing machining of carbon & alloy steels, at high cutting speeds and moderate feeds.

Qualité P20

Notamment pour usinages haute précision et semi-finition en aciers au carbone et alliés, à hautes vitesses de coupe et avances modérés.

Calidad M20

Especial para acabado y desbaste suave de aceros, aceros al manganeso, fundición y metales resistentes al calor o no ferrosos, a velocidades de corte medias o bajas.

M20 Quality

Special for finishing and soft roughing of steels, manganese-steels, cast iron and heat-resistant or non-ferrous materials, at medium or low cutting speed.

Qualité M20

Spécial finition et ébauche tendre d'aciers, aciers au manganèse, fonte et aciers résistants au chaud et non ferreux à faibles ou moyennes vitesses de coupe.

Calidad K10

Especial para mecanizados de gran precisión y semi-acabado en fundición, aceros aleados, materiales de viruta corta y no ferrosos.

K10 Quality

Special for high precision and semi-finishing machining of cast iron, alloyed steels, short chipping and non-ferrous materials.

Qualité K10

Spéciale pour usinage d'haute précision et semi-finition fonte, alliages aciers, aciers copeaux courts et non ferreux.

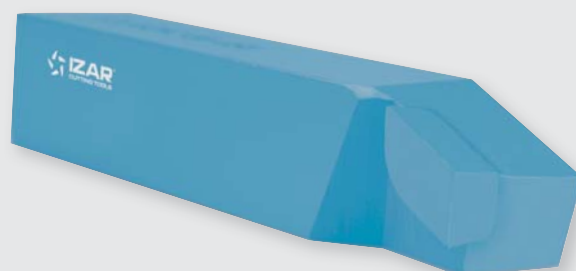

Ref. **8901**

HERRAMIENTA TORNEADO PLACA SOLDADA CILINDRADO 70°

70° Straight Brazed Turning Tool
Outil de tour plaquette soudé cylindrage 70°

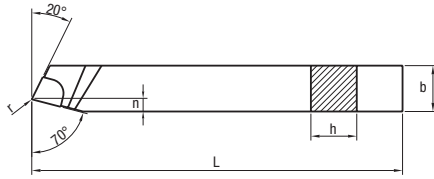

Aceros <850 N/mm ² Steel / Aciers	Aceros <1000 N/mm ² Steel / Aciers	Fundición Cast Iron Fonte
Aceros <1300 N/mm ² Steel / Aciers	INOX Stainless Steel Acier INOX	Cobre Copper Cuivre
Fundición Cast Iron Fonte		Aluminio Aluminium

h mm	b mm	L mm	R/L	n mm	r mm	Calidad Quality / Qualité P-20		Calidad Quality / Qualité K-10	
						N° Art.	€	N° Art.	€
10	10	90	- L	4	0,2	55888	7,92	55889	7,92
10	10	90	- R	4	0,2	55893	7,92	55891	7,92
12	12	100	- L	5	0,4	55894	8,51	55897	8,51
12	12	100	- R	5	0,4	55896	8,51	55899	8,51
16	16	110	- L	6	0,4	55903	10,71	55905	10,71
16	16	110	- R	6	0,4	55904	10,71	55906	10,71
20	20	125	- L	8	0,8	55911	14,62	55913	14,62
20	20	125	- R	8	0,8	55912	14,62	55914	14,62
25	25	140	- L	10	0,8	55917	21,62	55919	21,62
25	25	140	- R	10	0,8	55918	21,62	55920	21,62

Ref. **8900**

HERRAMIENTA TORNEADO PLACA SOLDADA ESCUADRADO 45°

45° Bent Brazed Turning Tool
Outil de tour plaquette soudé décolletage 45°

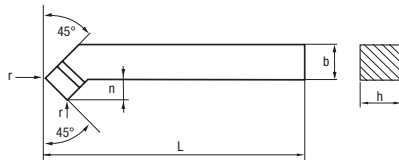
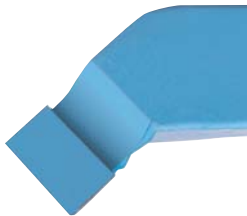

Aceros <850 N/mm ² Steel / Aciers	Aceros <1000 N/mm ² Steel / Aciers	Fundición Cast Iron Fonte
Aceros <1300 N/mm ² Steel / Aciers	INOX Stainless Steel Acier INOX	Cobre Copper Cuivre
Fundición Cast Iron Fonte	INOX Stainless Steel Acier INOX	Aluminio Aluminium

h mm	b mm	L mm	R/L	n mm	r mm	Calidad Quality / Qualité P-20		Calidad Quality / Qualité M-20		Calidad Quality / Qualité K-10	
						N° Art.	€	N° Art.	€	N° Art.	€
12	12	100	- L	7	0,4	13586	9,46	56073	9,46	29179	9,46
12	12	100	- R	7	0,4	13585	9,46	56074	9,46	29153	9,46
16	16	110	- L	8	0,4	13589	11,79	56076	11,79	29181	11,79
16	16	110	- R	8	0,4	13588	11,79	56077	11,79	18258	11,79
20	20	125	- L	10	0,8	13592	14,97	56078	14,97	13051	14,97
20	20	125	- R	10	0,8	13591	14,97	56079	14,97	28343	14,97
25	25	140	- L	12	0,8	13597	21,19	56080	21,19	29182	21,19
25	25	140	- R	12	0,8	13594	21,19	56082	21,19	26003	21,19

Ref. **8904**

HERRAMIENTA TORNEADO PLACA SOLDADA RANURADO EXTERIOR

Wide Face Square Nose Brazed Turning Tool

Outil de tour plaquette soudé rainurage extérieur

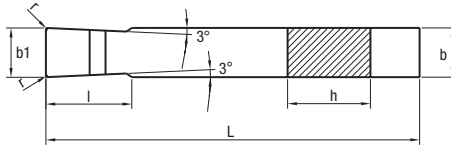
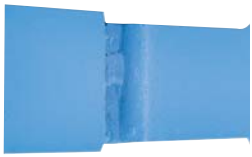

DIN
4976

ISO
4



Aceros <850 N/mm ² Steel / Aciers	Aceros <1000 N/mm ² Steel / Aciers	Fundición Cast Iron Fonte
Aceros <1300 N/mm ² Steel / Aciers	INOX Stainless Steel Acier INOX	Cobre Copper Cuivre
Fundición Cast Iron Fonte		Aluminio Aluminium

h mm	b mm	L mm	r mm	l mm	b1 mm	Calidad Quality / Qualité P-20		Calidad Quality / Qualité K-10	
						N° Art.	€	N° Art.	€
20	12	125	0,4	20	12	55924	11,51	55926	11,51
25	16	140	0,4	25	16	55928	16,03	55932	16,03
32	20	170	0,4	32	20	55936	24,04	55938	24,04

Ref. **8910**

HERRAMIENTA TORNEADO PLACA SOLDADA ESCUADRADO 90°

90° Offset Side Brazed Turning Tool

Outil de tour plaquette soudé décolletage 90°

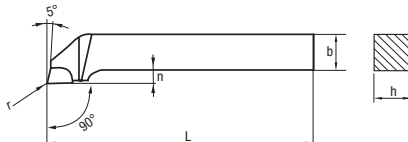
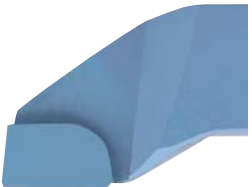

DIN
4980

ISO
6



Aceros <850 N/mm ² Steel / Aciers	Aceros <1000 N/mm ² Steel / Aciers	Fundición Cast Iron Fonte
Aceros <1300 N/mm ² Steel / Aciers	INOX Stainless Steel Acier INOX	Cobre Copper Cuivre
Fundición Cast Iron Fonte	INOX Stainless Steel Acier INOX	Aluminio Aluminium

h mm	b mm	L mm	R/L	n mm	r mm	Calidad Quality / Qualité P-20		Calidad Quality / Qualité M-20		Calidad Quality / Qualité K-10	
						N° Art.	€	N° Art.	€	N° Art.	€
10	10	090	- L	4	0,2	13601	8,56	56083	8,56	29183	8,56
10	10	090	- R	4	0,2	13600	8,56	56085	8,56	26488	8,56
12	12	100	- L	5	0,4	13604	9,50	56086	9,50	29185	9,50
12	12	100	- R	5	0,4	13603	9,50	56088	9,50	26707	9,50
16	16	110	- L	6	0,4	13607	11,52	56089	11,52	13058	11,52
16	16	110	- R	6	0,4	13606	11,52	56091	11,52	27460	11,52
20	20	125	- L	8	0,8	13612	15,34	56092	15,34	10825	15,34
20	20	125	- R	8	0,8	13609	15,34	56093	15,34	27461	15,34
25	25	140	- L	10	0,8	13616	22,33	56094	22,33	17090	22,33
25	25	140	- R	10	0,8	13615	22,33	56095	22,33	11181	22,33

Ref. **8920**

HERRAMIENTA TORNEADO PLACA SOLDADA TRONZADO

Parting Brazed Turning Tool
Outil de tour plaquette soudé tronçonnage

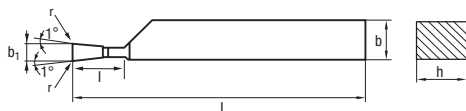

DIN
4981

ISO
7



Aceros <850 N/mm ² Steel / Aciers	Aceros <1000 N/mm ² Steel / Aciers
Aceros <1300 N/mm ² Steel / Aciers	INOX Stainless Steel Acier INOX
Fundición Cast Iron Fonte	

INOX
Stainless Steel
Acier INOX

Fundición Cast Iron Fonte
Cobre Copper Cuivre
Aluminio Aluminium

h mm	b mm	L mm	R/L	r mm	l mm	b1 mm	Calidad Quality / Qualité P-20		Calidad Quality / Qualité M-20		Calidad Quality / Qualité K-10	
							N° Art.	€	N° Art.	€	N° Art.	€
12	8	100	- L	0,2	12	3	13619	8,88			28344	8,88
12	8	100	- R	0,2	12	3	13618	8,88	56098	8,88	27519	8,88
16	10	110	- L	0,2	14	4	13622	9,69			29186	9,69
16	10	110	- R	0,2	14	4	13621	9,69	56100	9,69	19523	9,69
20	12	125	- L	0,2	16	5	13625	11,20			29187	11,20
20	12	125	- R	0,2	16	5	13624	11,20	56102	11,20	22685	11,20
25	16	140	- L	0,3	20	6	13628	14,85			29189	14,85
25	16	140	- R	0,3	20	6	13627	14,85	56104	14,85	29188	14,85

Ref. **8925**

HERRAMIENTA TORNEADO PLACA SOLDADA MANDRINADO

Boring Straight Brazed Turning Tool
Outil de tour plaquette soudé alésage

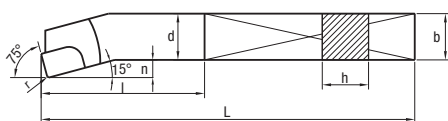

DIN
4973

ISO
8

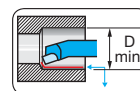

Aceros <850 N/mm ² Steel / Aciers	Aceros <1000 N/mm ² Steel / Aciers
Aceros <1300 N/mm ² Steel / Aciers	INOX Stainless Steel Acier INOX
Fundición Cast Iron Fonte	

Fundición Cast Iron Fonte
Cobre Copper Cuivre
Aluminio Aluminium

h mm	b mm	L mm	n mm	r mm	D min. mm	Calidad Quality / Qualité P-20		Calidad Quality / Qualité K-10	
						N° Art.	€	N° Art.	€
8	8	125	3	0,4	14	38218	11,33	38220	11,33
10	10	150	4	0,4	18	38222	11,67	38224	11,67
12	12	180	5	0,4	21	38227	12,00	38391	12,00
16	16	210	6	0,4	27	38393	13,47	38395	13,47
20	20	250	8	0,4	34	38397	17,50	38399	17,50
25	25	300	10	0,8	43	38401	27,55	38403	27,55



Ref. **8930**

HERRAMIENTA TORNEADO PLACA SOLDADA CILINDRADO INTERIOR

Internal Sharped Brazed Turning Tool
Outil de tour plaquette soudé cylindrage intérieur

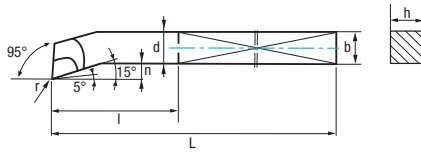

DIN
4974

ISO
9

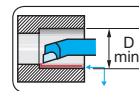

Aceros <850 N/mm ² Steel / Aciers	Aceros <1000 N/mm ² Steel / Aciers
Aceros <1300 N/mm ² Steel / Aciers	INOX Stainless Steel Acier INOX
Fundición Cast Iron Fonte	

INOX
Stainless Steel
Acier INOX

Fundición Cast Iron Fonte
Cobre Copper Cuivre
Aluminio Aluminium

h mm	b mm	L mm	d mm	n mm	r mm	l mm	D min. mm	Calidad Quality / Qualité P-20		Calidad Quality / Qualité M-20		Calidad Quality / Qualité K-10	
								N° Art.	€	N° Art.	€	N° Art.	€
8	8	125	8	3	0,2	40	14	13630	11,67	56114	11,67	14971	11,67
10	10	150	10	4	0,2	50	18	13631	11,52	56115	11,52	27462	11,52
12	12	180	12	5	0,2	63	21	13633	12,22	56116	12,22	27464	12,22
16	16	210	16	6	0,2	80	27	13634	14,56	56117	14,56	11152	14,56
20	20	250	20	8	0,4	100	34	13636	18,41	56118	18,41	11754	18,41
25	25	300	25	10	0,4	125	43	13639	27,96	56119	27,96	27518	27,96
32	32	355	32	12	0,8	160	52	13642	49,21	56121	49,21	13896	49,21

Ref. **8940**

HERRAMIENTA TORNEADO PLACA SOLDADA CILINDRADO RECTO

Sharped Straight Brazed Turning Tool
Outil de tour plaquette soudé cylindrage droit

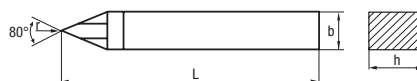
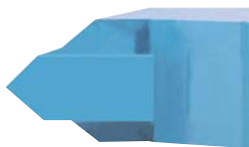

DIN
4975

ISO
10



Aceros <850 N/mm ² Steel / Aciers	Aceros <1000 N/mm ² Steel / Aciers
Aceros <1300 N/mm ² Steel / Aciers	INOX Stainless Steel Acier INOX
Fundición Cast Iron Fonte	

Fundición Cast Iron Fonte
Cobre Copper Cuivre
Aluminio Aluminium



h mm	b mm	L mm	r mm	Calidad Quality / Qualité P-20		Calidad Quality / Qualité K-10	
				N° Art.	€	N° Art.	€
16	10	110	0,2	13645	8,71	29190	8,71
20	12	125	0,4	13646	10,09	29191	10,09
25	16	140	0,4	13648	12,88	29192	12,88

Ref. **8950**

HERRAMIENTA TORNEADO PLACA SOLDADA RANURADO INTERIOR

Internal Undercutting Brazed Turning Tool
Outil de tour plaquette soudé rainurado intérieur

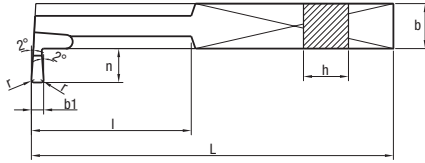

Aceros <850 N/mm ² Steel / Aciers	Aceros <1000 N/mm ² Steel / Aciers	Fundición Cast Iron Fonte
Aceros <1300 N/mm ² Steel / Aciers	INOX Stainless Steel Acier INOX	Cobre Copper Cuivre
Fundición Cast Iron Fonte		Aluminio Aluminium

h mm	b mm	L mm	n mm	r mm	b1 mm	D min. mm	Calidad Quality / Qualité P-20		Calidad Quality / Qualité K-10	
							N° Art.	€	N° Art.	€
12	12	180	10	0,2	4	32	38405	19,05	38407	19,05
16	16	210	12	0,2	5	40	38409	23,81	38411	23,81
20	20	250	16	0,4	6	50	38413	30,06	38415	30,06
25	25	300	20	0,4	8	63	38417	37,78	38419	37,78

Ref. **8960**

HERRAMIENTA TORNEADO PLACA SOLDADA ROSCADO EXTERIOR

External Threading Brazed Turning Tool
Outil de tour plaquette soudé taraudage extérieur

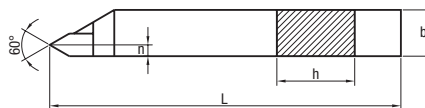

Aceros <850 N/mm ² Steel / Aciers	Aceros <1000 N/mm ² Steel / Aciers	Fundición Cast Iron Fonte
Aceros <1300 N/mm ² Steel / Aciers	INOX Stainless Steel Acier INOX	Cobre Copper Cuivre
Fundición Cast Iron Fonte		Aluminio Aluminium

h mm	b mm	L mm	R/L	n mm	Calidad Quality / Qualité P-20		Calidad Quality / Qualité K-10	
					N° Art.	€	N° Art.	€
16	10	110	- L	2,0	38422	10,58	38424	10,58
16	10	110	- R	2,0	38421	10,58	38423	10,58
20	12	125	- L	2,5	38426	12,40	38428	12,40
20	12	125	- R	2,5	38425	12,40	38427	12,40
25	16	140	- L	3,0	38430	16,14	38432	16,14
25	16	140	- R	3,0	38429	16,14	38431	16,14

Ref. **8970**

HERRAMIENTA TORNEADO PLACA SOLDADA ROSCADO INTERIOR

Internal Threading Brazed Turning Tool

Outil de tour plaquette soudé taraudage intérieur

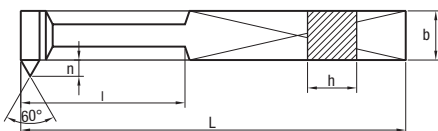

DIN
283

ISO
13

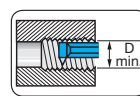

Aceros <850 N/mm ² Steel / Aciers	Aceros <1000 N/mm ² Steel / Aciers	Fundición Cast Iron Fonte
Aceros <1300 N/mm ² Steel / Aciers	INOX Stainless Steel Acier INOX	Cobre Copper Cuivre
Fundición Cast Iron Fonte		Aluminio Aluminium

h mm	b mm	L mm	R/L	n mm	D min. mm	Calidad Quality / Qualité P-20		Calidad Quality / Qualité K-10	
						N° Art.	€	N° Art.	€
10	10	150	- L	5	22	38434	18,16	38436	18,16
10	10	150	- R	5	22	38433	18,16	38435	18,16
12	12	180	- L	6	24	38438	18,49	38440	18,49
12	12	180	- R	6	24	38437	18,49	38439	18,49
16	16	210	- L	8	32	38442	24,30	38444	24,30
16	16	210	- R	8	32	38441	24,30	38443	24,30
20	20	250	- L	10	40	38446	28,84	38448	28,84
20	20	250	- R	10	40	38445	28,84	38447	28,84
25	25	300	- L	12	49	38450	40,91	38452	40,91
25	25	300	- R	12	49	38449	40,91	38451	40,91

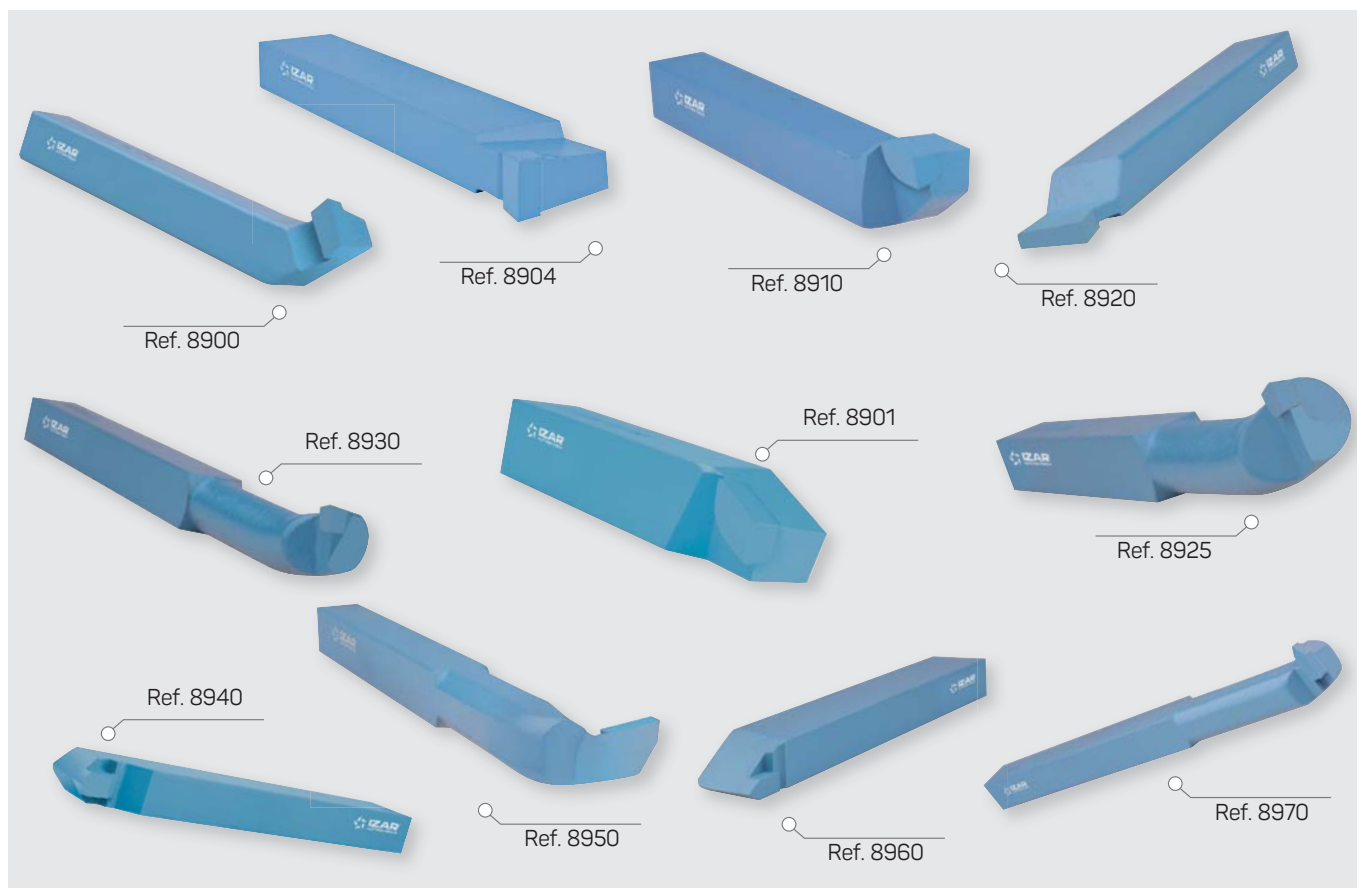

Ref. **8990**

CUCHILLA CUADRADA TORNEADO

Square Turning Blade
Outil de tour carré

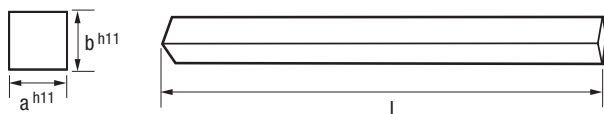

Cuchillas Torno
Turning Tools
Outils de tour

HSSE
10%Co

DIN
4964B



a mm	b mm	L mm	Nº Art.	€
6	x 6	x 100	35462	11,31
6	x 6	x 160	35463	16,88
6	x 6	x 200	35464	20,97
8	x 8	x 100	35465	19,01
8	x 8	x 160	35466	26,19
8	x 8	x 200	35467	31,25
10	x 10	x 100	35468	27,15
10	x 10	x 160	35469	40,35
10	x 10	x 200	35470	51,75
12	x 12	x 100	35471	33,15
12	x 12	x 160	35472	46,41
12	x 12	x 200	35473	60,32
14	x 14	x 200	35474	71,60
16	x 16	x 200	35475	89,15
18	x 18	x 200	35476	129,51
20	x 20	x 200	35477	166,94
25	x 25	x 200	35478	261,56

Ref. **8991**

CUCHILLA REDONDA TORNEADO

Round Turning Blade
Outil de tour rond

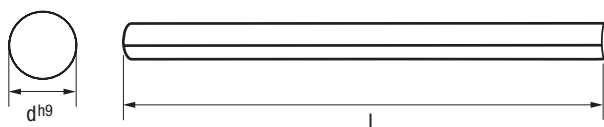

Cuchillas Torno
Turning Tools
Outils de tour

HSSE
10%Co

DIN
4964A



d mm	L mm	Nº Art.	€
4	x 100	35479	9,62
5	x 100	35480	11,04
5	x 200	35481	22,14
6	x 100	35482	12,48
6	x 160	35484	18,75
6	x 200	35483	22,80
8	x 100	35485	16,32
8	x 160	35486	25,70
8	x 200	35487	30,54
10	x 100	35488	24,17
10	x 160	35489	42,90
10	x 200	35490	53,04
12	x 100	35491	26,43
12	x 200	35492	68,60
14	x 200	35493	95,64
16	x 200	35494	100,68
18	x 200	35495	174,75
20	x 200	35497	176,03

Ref. **8992**

CUCHILLA TRAPEZOIDAL TORNEADO

Trapezoidal Turning Blade
Outil de tour trapézoïdal



HSSE
10%Co

DIN
4964E

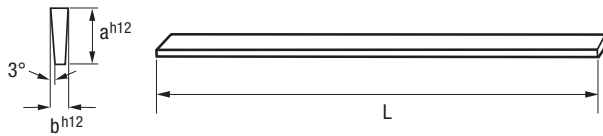

a mm	b mm	L mm	Nº Art.	€
10	2,50	100	13690	18,90
12	3,00	100	13691	20,90
12	3,00	160	13693	29,90
16	4,00	100	13782	30,32
16	4,00	160	13786	61,55
20	5,00	160	13787	76,01
20	5,00	200	14213	104,99
25	6,00	160	14225	102,44

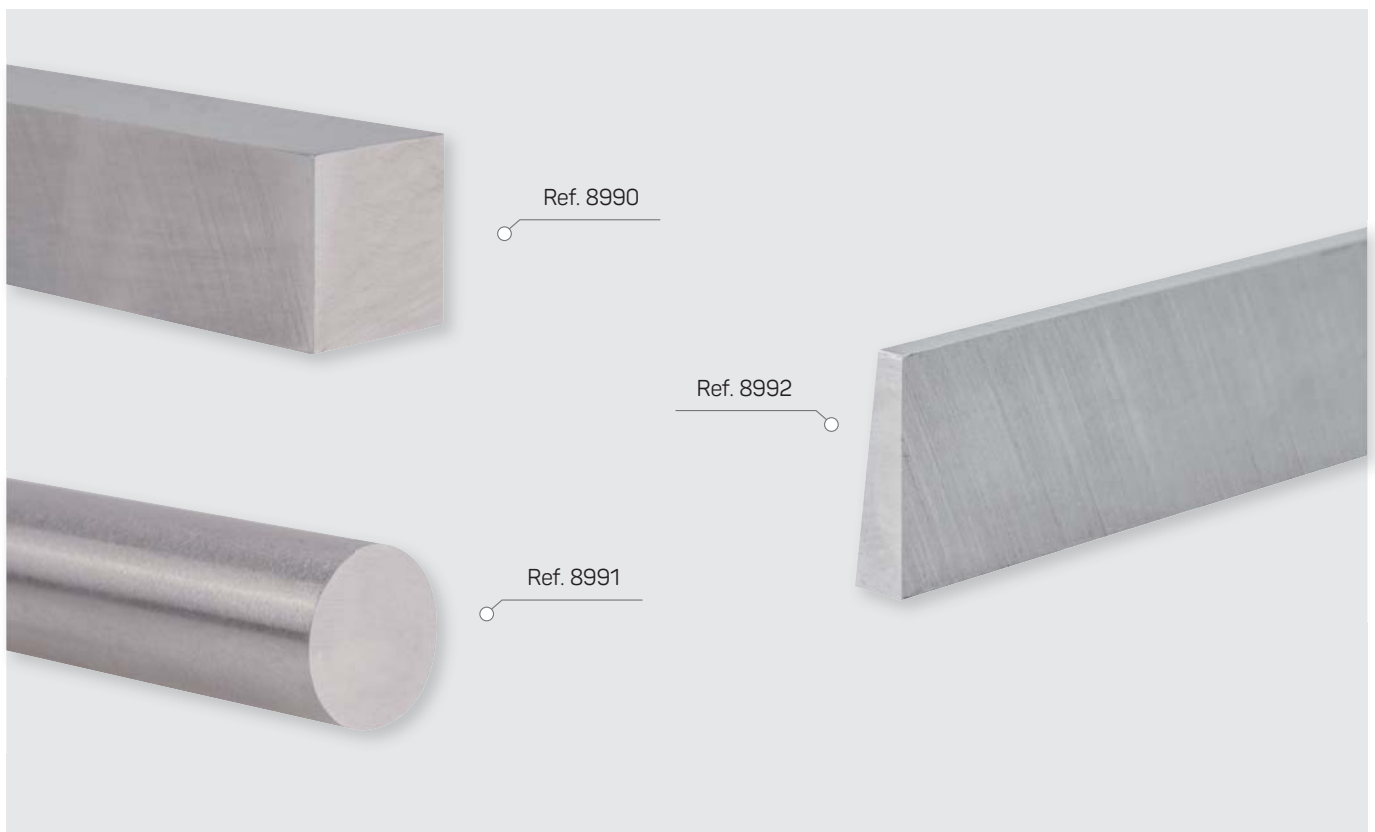

Ref. 8990

Ref. 8992

Ref. 8991

Ref. **8301**

GRANETE
Centre Punch
Pointeau à marquer



D mm	d mm	L mm		Nº Art.	€ 1 ud.
2	9	130	10	13302	3,93
4	9	130	10	13304	3,93
5	11	150	10	13305	7,10
8	11	160	10	13307	7,10

Ref. 8301

Hasta fin de existencias
While stock lasts
Jusqu'à la fin de stock



Ref. **8302**

BOTADOR CÓNICO
Taper Punch
Poinçon conique



D mm	d mm	L mm		Nº Art.	€ 1 ud.
2	9	130	10	13308	5,22
4	9	130	10	13309	5,22
5	9	130	10	13310	5,22
6	11	160	10	13311	6,54
8	11	160	10	13312	6,58
10	11	160	10	13313	6,75

Ref. 8302

Hasta fin de existencias
While stock lasts
Jusqu'à la fin de stock



Ref. **8303**

BOTADOR CILÍNDRICO
Parallel Punch
Poinçon cylindrique



D mm	d mm	L mm		Nº Art.	€ 1 ud.
2	9	160	10	13314	3,82
3	9	160	10	13315	3,87
4	9	160	10	13317	3,90
5	11	160	10	13316	4,77
6	11	160	10	13318	4,79
7	11	160	10	13324	4,79
9	11	160	10	13916	4,87
10	11	160	10	13917	4,87

Ref. 8303

Hasta fin de existencias
While stock lasts
Jusqu'à la fin de stock



Ref. **8304**

CINCEL Y BURIL
Cold & Cape Chisel
Ciseau et burin



Ref. 8304

Hasta fin de existencias
While stock lasts
Jusqu'à la fin de stock

Tipo Type Type	D mm	d mm	L mm		Nº Art.	€ 1 ud.
Cinzel Cold Chisel Ciseau	12	9,5	13	10	13918	7,43
Buril Cape Chisel Burin	5	9,5	13	10	13920	8,82

Ref. **8310**

SETS GRANETES, BOTADORES, CINCELES Y BURILES

Punches and Chisels Sets

Sets pointeaux, poinçons, ciseaux et burins

Ref. 8310

Hasta fin de existencias / while stock lasts / jusqu'à la fin de stock



Mod. **1**

6 Pcs

Cont. Ref.	Cont. Descrip.	Nº Art.	€
8304 8302 8301	Buril, Cincel, Cónicos 2-4, Granetes 4-6 Cold & Cape Chisel, Taper 2-4 & Centre Punch. 4-6 Burin, Ciseau, Coniques 2-4, Pointeaux 4-6	13921	42,80



Mod. **2**

6 Pcs

Cont. Ref.	Cont. Descrip.	Nº Art.	€
8304 8302 8301 8303	Buril, Cincel, Cónico 4, Granete 4, Cilíndricos 4-8 Cold & Cape Chisel, Taper 4, Centre 4 & Parallel 4-8 Burin, Ciseau, Conique 4, Pointeau 4, Cylindriques 4-8	13923	42,59



Mod. **3**

6 Pcs

Cont. Ref.	Cont. Descrip.	Nº Art.	€
8304 8301	Buril, Cincel, Granetes 2-4-6-8 Cold & Cape Chisel, Centre Punches 2-4-6-8 Burin, Ciseau, Pointeaux 2-4-6-8	13924	45,04



Mod. **4**

6 Pcs

Cont. Ref.	Cont. Descrip.	Nº Art.	€
8302	Cónicos 2-4-5-6-8-10 Taper Punches 2-4-5-6-8-10 Coniques 2-4-5-6-8-10	13926	39,47



Mod. **6**

6 Pcs

Cont. Ref.	Cont. Descrip.	Nº Art.	€
8303	Cilíndricos 5-6-7-8-9-10 Parallel Punches 5-6-7-8-9-10 Cylindriques 5-6-7-8-9-10	13928	42,87

Ref. **8352**

REBARBADOR EXTERIOR

External Chamfer Tool
Outil de chanfrein externe

New!

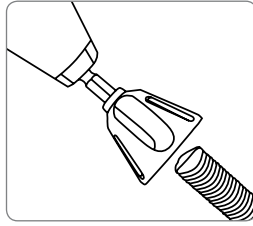

1/4"
DIN E6.3

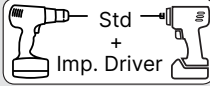

Aceros
<850 N/mm²
Steel / Aciers

Fundición
Cast Iron
Fonte

Cobre
Copper
Cuivre

Latón
Brass
Laiton

Aluminio
Aluminium

Cap.	Nº Art.	€
Ø 6 - 25 mm	25381	16,70

Ref. **8350**

JUEGO REBARBADORES

Deburring Tool Sets
Jeux ébavureurs



MOD. B



Juego
Mod. B
Set



Aceros
<850 N/mm²
Steel / Aciers

Fundición
Cast Iron
Fonte

Cobre
Copper
Cuivre

Latón
Brass
Laiton

Aluminio
Aluminium

Plásticos
Plastics
Plastiques



4 Pcs

Cont.	Nº Art.	€
Mango / Shank / Queue Porta Universal Holder B10 / B20	12816	22,95

MOD. E



Juego
Mod. E
Set



Aceros
<850 N/mm²
Steel / Aciers

Fundición
Cast Iron
Fonte

Cobre
Copper
Cuivre

Latón
Brass
Laiton

Aluminio
Aluminium

Plásticos
Plastics
Plastiques



5 Pcs

Cont.	Nº Art.	€
Mango / Shank / Queue Porta Universal Holder E100 / E200 / E300	12805	25,91

Ref. **8351**

ACCESORIOS REBARBADORES

Deburring Tool Accessories
Accessoires ébavureurs



Mango / Shank / Queue

Medida Size - Dimension	Icon	Nº Art.	€
00001		1 12834	11,11



Porta **Universal** Holder

Medida Size - Dimension	Icon	Nº Art.	€
00006UNI		1 76576	9,02



Cuchillas Blades Lames	Material Materiel	Icon	Nº Art.	€ pack
B10	HSS		10 12825	15,95
B20	HSS		10 12827	15,95



Cuchillas Blades Lames	Material Materiel	Icon	Nº Art.	€ pack
E100	HSS		10 12829	18,93
E100S	HSSE		10 12830	20,69
E200	HSS		10 12831	18,93
E300	HSS		10 12833	21,80

Aplicación Application Application	Material Material Materiel	Aceros <850 N/mm² Steel / Aciers		Latón Brass Laiton	INOX Stainless Steel Acier INOX	Plásticos Plastics Plastiques
		Aluminio Aluminium	Fundición Cast Iron Fonte			
Bordes rectos Straight Edges Bouts droits		B10 E100		B20 E200	E100S	B10 E100 E100S B20 E200
Bordes de Agujeros Hole Edges Bouts de trous		E100S				
Bordes Agujeros Pasantes Through Hole Edges Bouts de trous débouchants		E300				E300

Ref. **8325**

CORTA TUBOS 25 mm

25 mm Pipe Cutters
Coupe tubes 25 mm

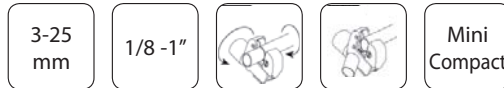

INOX
Stainless Steel
Acier INOX

Cobre
Copper
Cuivre

Aluminio
Aluminium

Mod.	Min. mm	Max. mm	Pulgadas Inches Pouces	Nº Art.	€
25	3	25	1/8 - 1"	34244	13,70

Ref. **8330**

CORTA TUBOS 30 mm

30 mm Pipe Cutters
Coupe tubes 30 mm



INOX
Stainless Steel
Acier INOX

Cobre
Copper
Cuivre

Aluminio
Aluminium

Mod.	Min. mm	Max. mm	Pulgadas Inches Pouces	Nº Art.	€
30	3	30	1/8 - 1 1/8"	34245	14,19

Ref. **8335**

CORTA TUBOS 35 mm

35 mm Pipe Cutters
Coupe tubes 35 mm



Cambio Rápido Cuchilla
Quick Cutting Wheel Change
Changement rapide molette

Rebarbador incluido
Deburring Tool included
Ébavureur compris

INOX
Stainless Steel
Acier INOX

Cobre
Copper
Cuivre

Aluminio
Aluminium

Mod.	Min. mm	Max. mm	Pulgadas Inches Pouces	Nº Art.	€
35	3	35	1/8 - 1 3/8"	34246	34,81

Ref. **8341**

CUCHILLAS REPUESTO

Spare Wheels
Lames de rechange

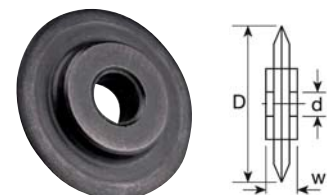

Mod.	D mm	d mm	w mm	Nº Art.	€
1	20	5	5	34247	2,70



Ref. **8326**

CORTA TUBOS TIJERA PLÁSTICO Y MULTICAPA

Plastic & Multilayer Pipe Scissors

Coupe tubes ciseaux pour plastique et multicouche



26 mm
(1")

INOX+Teflon®
Stainless+Teflon®
INOX+Téflon®



Cuerpo Mg
Mg Body
Corps Mg

PE, PP, PB, PEX, MLP/MSR, VPE, CPVC,
PVC, PVDF, PPR

- 1- Cuchilla INOX + Teflon®: Menor adherencia entre tubo y cuchilla
- 2- Zona de apoyo mejorada: Tubo mejor asentado, corte más preciso
- 3- Cambio cuchilla instantaneo: Sin necesidad de herramientas

- 1- Stainless + Teflon® blade: Lower adhesion between pipe & blade
- 2- Improved base area: Better leaned pipe, accurate cutting
- 3- Instant blade change: No tools needed

- 1- Lame INOX + Téflon®: Moindre adhérence entre tuyau et lame
- 2- Zone d'appui améliorée: Tuyau mieux fixé, coupe plus précis
- 3- Changement de lame immédiat: Sans besoin d'outils



Mod.	Max. mm	Pulgadas Inches Pouces	Nº Art.	€
26	26	1"	36633	30,40

Ref. **8321**



INOX+Teflon®
Stainless+Teflon®
INOX+Téflon®



Hoja Blade Lame mm		Nº Art.	€
26	1	37423	11,47

Ref. **8342**

CORTA TUBOS TIJERA PLÁSTICO Y MULTICAPA

Plastic & Multilayer Pipe Scissors

Coupe tubes ciseaux pour plastique et multicouche



42 mm
(1 5/8")

INOX+Teflon®
Stainless+Teflon®
INOX+Téflon®



Cuerpo Mg
Mg Body
Corps Mg

PE, PP, PB, PEX, MLP/MSR, VPE, CPVC,
PVC, PVDF, PPR

- 1- Cuchilla INOX + Teflon®: Menor adherencia entre tubo y cuchilla
- 2- Zona de apoyo mejorada: Tubo mejor asentado, corte más preciso
- 3- Cambio cuchilla instantaneo: Sin necesidad de herramientas
- 4- Cuchilla recogida en el cuerpo

- 1- Stainless + Teflon® blade: Lower adhesion between pipe & blade
- 2- Improved base area: Better leaned pipe, accurate cutting
- 3- Instant blade change: No tools needed
- 4- Blade positioned within the body

- 1- Lame INOX + Téflon®: Moindre adhérence entre tuyau et lame
- 2- Zone d'appui améliorée: Tuyau mieux fixé, coupe plus précis
- 3- Changement de lame immédiat: Sans besoin d'outils
- 4- Lame dans le corps de l'outil



Mod.	Max. mm	Pulgadas Inches Pouces	Nº Art.	€
42	42	1 5/8	36635	52,78

Ref. **8321**



INOX+Teflon®
Stainless+Teflon®
INOX+Téflon®



Hoja Blade Lame mm		Nº Art.	€
42	1	37424	21,26

Ref. **8345****RECOGEVIRUTAS MAGNÉTICO**Magnetic Retrieving Baton
Aimant à copeaux

D mm	L mm	Nº Art.	€
25,40	400	69499	55,86

Imán especialmente diseñado para recoger viruta ferrosa en lugares difícilmente accesibles. Ideal para cubos de almacenaje, limpieza de agua o desengrasado de tanques, muros y esquinas... Práctico extensor que deja caer el material recogido a la vez que protege la mano de la viruta.

Specially designed Magnet to retrieve ferrous metal materials from hard to reach locations. Ideal for storage bins, water cleaning or tank degreasing, walls and corners... Practical extension for an easy releasing the collected material. It protects the hand from the chips.

Aimant spécialement dessiné pour ramasser les copeaux de fer dans des zones de difficile accès. Conseillés pour nettoyage d'eau, murs, corners. Pratique extenseur qui permet que le matériel tombe une fois ramassé et protège les mains des copeaux.

CONSTRUCCIÓN

Construction
Construction

HERRAMIENTAS SDS PLUS

SDS plus Tools
Outils SDS plus

210

HERRAMIENTAS SDS MAX

SDS max Tools
Outils SDS max

220

ADAPTADOR iCONNECT

iConnect Adaptor
Adaptateur iConnect

224

CINCELES

Chisels
Burins

226

BROCAS MANGO CILÍNDRICO

Straight Shank Drill Bits
Forets queue cylindrique

230

CORONAS

Hole Saws
Tréfans

247

DISCOS DIAMANTE

Diamond Cutting Blades
Disques diamant

257

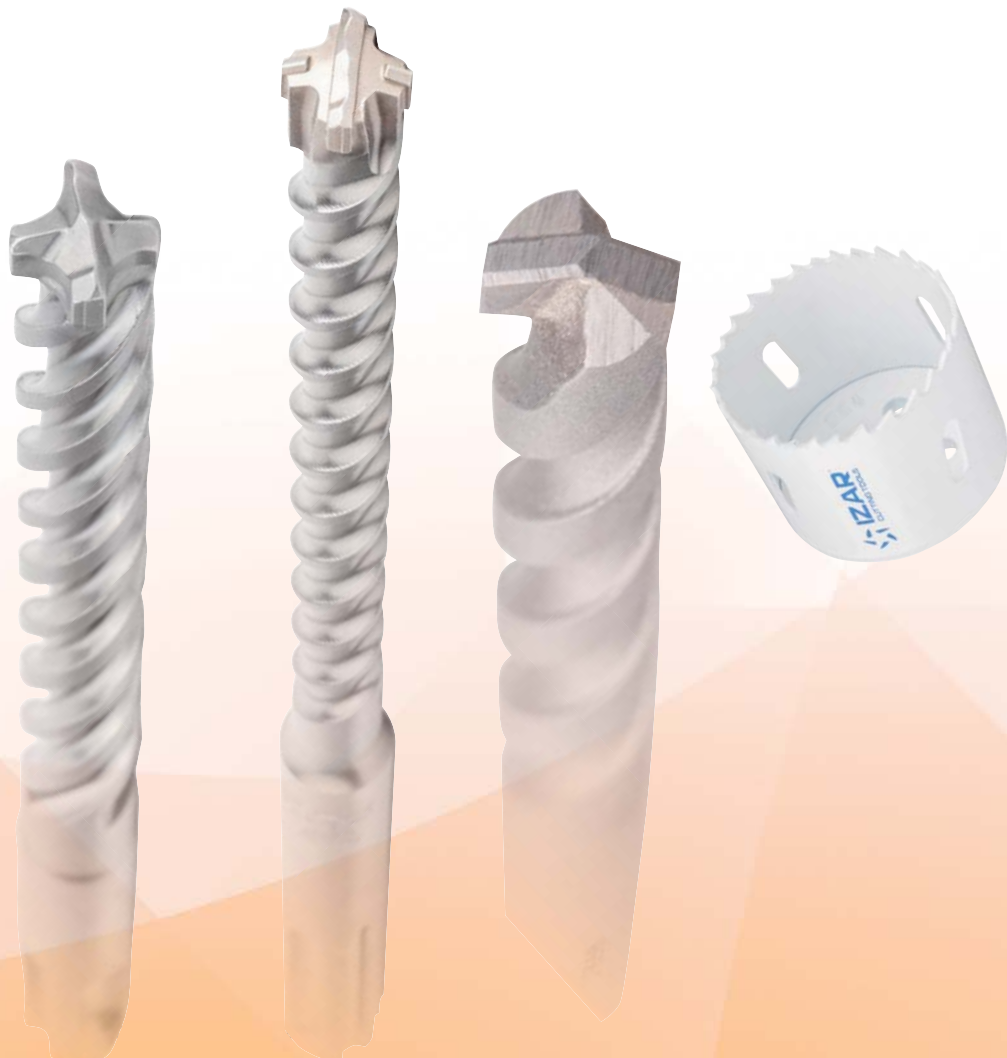

HERRAMIENTAS SDS PLUS

SDS plus Tools

Outils SDS plus

Ref. **1891**

BROCA-MARTILLO SDS PLUS 4Z+

4Z+ Cutter SDS plus Rotary Hammer Drill Bit

Foret percussion SDS plus 4Z+

Zentro 4+



Zentro
4+
<10mm

Zentro
4
10-16 mm

SDS
plus



Video



Hormigón Reforzado
Reinforced Concrete
Béton armé

Hormigón
Concrete
Béton

Hormigón Bloque
Concrete Block
Parpaing

Piedra Natural
Natural Stone
Pierre naturelle



Punta centradora MD soldada al cuerpo

Solid carbide centering tip welded to the body

Pointe autocentrante carbure soudée au corps



Hombros reforzados

=> Mejor rotura del material.
Marca desgaste

Reinforced shoulders

=> Better material breaking.
Wear Marking

Épaules de la pointe reforçadas

=> Meilleure rupture du matériel.
Marque l'usure.

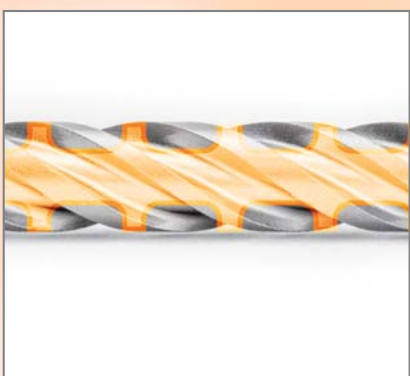

Diseño nucleo reforzado exclusivo

=> Mejor rendimiento y vida más larga

Exclusive reinforced core design

=> Better performance & longer life

Dessin noyau renforcé et exclusif

=> Meilleure performance et vie de l'outil plus longue

Ref. **1891**

BROCA-MARTILLO SDS PLUS 4Z+

4Z+ Cutter SDS plus Rotary Hammer Drill Bit
Foret percussion SDS plus 4Z+

D mm	L mm	I mm		Nº Art.	€
5,00	115	50	1	32043	5,09
5,00	165	100	1	32044	5,69
5,00	215	150	1	55961	8,34
5,00	265	200	1	66376	10,40
5,00	315	250	1	69437	13,35
5,50	115	50	1	32041	6,76
5,50	165	100	1	32042	7,07
6,00	115	50	1	32045	4,98
6,00	165	100	1	32046	5,46
6,00	215	150	1	32047	7,35
6,00	265	200	1	32048	8,82
6,00	315	250	1	32049	12,92
6,50	165	100	1	32050	7,08
6,50	215	150	1	32074	9,59
6,50	265	200	1	32072	12,78
6,50	315	250	1	32073	15,55
7,00	115	50	1	32052	6,72
7,00	165	100	1	32053	7,12
7,00	215	150	1	68615	9,82
8,00	115	50	1	32054	6,54
8,00	165	100	1	32055	6,54
8,00	215	150	1	32056	8,20
8,00	265	200	1	32057	9,00
8,00	315	250	1	36686	11,49
8,00	465	400	1	36687	19,01
9,00	165	100	1	56808	8,76
10,00	115	50	1	32058	7,43

D mm	L mm	I mm		Nº Art.	€
10,00	165	100	1	32059	7,94
10,00	215	150	1	32060	9,48
10,00	265	200	1	32061	12,20
10,00	315	250	1	32062	15,52
10,00	455	400	1	32063	21,28
10,00	600	550	1	36688	27,13
10,00	1000	950	1	36689	63,64
11,00	160	110	1	69899	10,37
11,00	210	160	1	69902	12,49
11,00	260	210	1	69904	14,70
11,00	310	260	1	81562	19,57
12,00	160	110	1	32064	9,86
12,00	210	160	1	32065	11,77
12,00	260	210	1	32066	14,26
12,00	310	260	1	32067	18,53
12,00	450	400	1	32068	23,16
12,00	600	550	1	36690	27,86
12,00	1000	950	1	36697	63,97
13,00	160	110	1	69905	11,49
13,00	210	160	1	69907	19,20
13,00	260	210	1	69908	21,77
13,00	310	260	1	81563	23,32
14,00	160	110	1	32069	11,40
14,00	210	160	1	32070	15,30
14,00	260	210	1	32071	17,11
14,00	310	260	1	36691	21,93
14,00	450	400	1	36692	27,48

D mm	L mm	I mm		Nº Art.	€
14,00	600	550	1	36693	38,36
14,00	1000	950	1	36694	85,82
15,00	160	110	1	60059	17,62
15,00	260	210	1	60061	22,87
15,00	450	400	1	60062	29,69
16,00	160	110	1	36695	21,80
16,00	210	160	1	36696	24,52
16,00	260	210	1	36863	28,36
16,00	310	260	1	36699	29,63
16,00	450	400	1	37455	37,13
16,00	600	550	1	22113	50,10
16,00	1000	950	1	36698	101,73
18,00	250	200	1	16919	37,98
18,00	450	400	1	16920	44,63
20,00	250	200	1	16921	42,89
20,00	450	400	1	16922	51,15
22,00	250	200	1	39687	51,75
22,00	450	400	1	16925	61,60
24,00	250	200	1	39688	58,09
24,00	450	400	1	16927	65,20
25,00	250	200	1	39689	59,67
25,00	450	400	1	16928	66,11
28,00	250	200	1	11523	68,95
28,00	450	400	1	11524	75,99
30,00	250	200	1	39690	88,18
30,00	450	400	1	11525	96,23
32,00	450	400	1	11526	107,44



Línea 1m
1891

BROCA-MARTILLO SDS PLUS 4Z+

4Z+ Cutter SDS plus Rotary Hammer Drill Bit
Foret percussion SDS plus 4Z+



Ø	5	6	7	8	10	5	6	7	8	10	12	14	6	8	10	12	14	8	16
Pcs	L115	L115	L115	L115	L115	L165	L165	L165	L165	L165	L160	L160	L215	L215	L215	L210	L210	L265	L260
	2	2	2	2	2	2	2	2	2	2	2	2	2	2	2	2	2	2	2

Ref. 4995 - Nº Art. 71015: **348,43 €**



Display 67



BROCA-MARTILLO SDS PLUS 4Z+ (1)

4Z+ Cutter SDS plus Rotary Hammer Drill Bit (1)

Foret percussion SDS plus 4Z+ (1)

∅	24 L250	6 L315	8 L315	10 L315	12 L310	14 L310	16 L310	8 L465
Pcs	1	2	2	1	1	1	1	1
∅	5 L215	6 L215	8 L215	10 L215	12 L210	14 L210	16 L210	6 L265
Pcs	3	3	3	2	2	2	2	2
∅	5 L115	6 L115	7 L115	8 L115	10 L115	5 L165	6 L165	6 L165
Pcs	4	4	4	4	3	4	3	3

Ref. 4995 - Nº Art. 75389: 594,08 €

Display 68



BROCA-MARTILLO SDS PLUS 4Z+ (2)

4Z+ Cutter SDS plus Rotary Hammer Drill Bit (2)

Foret percussion SDS plus 4Z+ (2)

∅	10 L455	12 L450	14 L450	16 L450	18 L450	20 L450	22 L450	24 L450
Pcs	1	1	1	1	1	1	1	1
∅	8 L265	10 L265	12 L260	14 L260	16 L260	18 L250	20 L250	22 L250
Pcs	2	2	1	1	1	1	1	1
∅	7 L165	8 L165	9 L165	10 L165	12 L160	14 L160	15 L160	16 L160
Pcs	2	2	2	2	1	1	1	1

Ref. 4995 - Nº Art. 75391: 687,75 €

Display 61



BROCA-MARTILLO SDS PLUS 4Z+ (BÁSICO)

4Z+ Cutter SDS plus Rotary Hammer Drill Bit (Basic)

Foret percussion SDS plus 4Z+ (Essentiel)

∅	14 L210	6 L265	8 L265	10 L265	12 L260	6 L315	10 L315	12 L310
Pcs	2	2	2	2	2	2	2	2
∅	8 L165	10 L165	12 L160	14 L160	6 L215	8 L215	10 L215	12 L210
Pcs	2	2	2	2	2	2	2	2
∅	5 L115	6 L115	7 L115	8 L115	10 L115	5 L165	6 L165	7 L165
Pcs	2	2	2	2	2	2	2	2

Ref. 4995 - Nº Art. 29487: 456,21 €

Display 31

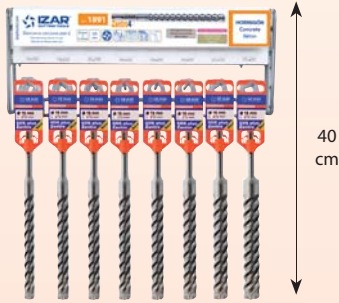

40 cm

Display 32



60 cm

Ø	16	18	20	22	24	25	28	30
	L260	L250	L250	L250	L250	L250	L250	L250
Pcs	1	1	1	1	1	1	1	1

Ref. 4995 - Nº Art. 22615: 435,86 €

Ø	16	18	20	22	24	25	28	30
	L450	L450	L450	L450	L450	L450	L450	L450
Pcs	1	1	1	1	1	1	1	1

Ref. 4995 - Nº Art. 22617: 498,02 €

Ref. **1869**

BROCA-MARTILLO SDS PLUS 4Z+

4Z+ Cutter SDS plus Rotary Hammer Drill Bit
Foret percussion SDS plus 4Z+

D mm	L mm	I mm		Nº Art.	€ 1 ud.
5	115	50	10	56503	4,82
5	165	100	10	56506	5,41
6	115	50	10	56507	4,74
6	165	100	10	56509	5,18
6	215	150	10	56510	6,99
8	115	50	10	56967	6,21
8	165	100	10	56971	6,21

D mm	L mm	I mm		Nº Art.	€ 1 ud.
8	215	150	10	56972	7,79
10	115	50	10	56973	7,07
10	165	100	10	56974	7,55
10	215	150	10	56976	9,00
12	160	110	10	56978	9,36
12	210	160	10	56979	11,17



Ref. **1489**

7 Pcs

Cont. Ø	Nº Art.	€
5-6-8 x 115 + 6-8-10-12 x 165 mm	39851	41,77

Ref. **1890**

BROCA-MARTILLO SDS PLUS

SDS plus Rotary Hammer Drill Bit
Foret percussion SDS plus



Hormigón
Concrete
Béton

Hormigón Bloque
Concrete Block
Parpaing



Puntos de desbaste efecto "demolición".
Producen micro-fisuras en el material.

"Demolition" effect power breakers.
Produce micro cracks in the material.

Points d'ébauche effet "démolition".
Produit des micro-fissures dans le matériel.



Punta centrado inmediato.
Previene que resbale en superficies lisas.

Immediate centering tip.
Prevent skidding on smooth surfaces.

Pointe Autocentrage immédiat.
Il prévient le glissement sur Surfaces lisses.



Chañflanes de acero corrugado más extenso (+35%).
Previenen daños laterales en la punta.

Enlarged rebar chamfers (+35%).
Prevent side tip damage.

Chanfreins aciers contractés plus étendus (+35%).
Il prévient des dommages aux côtés de la pointe.



D mm	L mm	I mm		Nº Art.	€
4,0	110	50	1	30245	4,20
4,0	160	100	1	43405	5,11
5,0	110	50	1	30246	3,04
5,0	160	100	1	30247	3,96
5,0	210	150	1	42770	6,32
5,0	260	200	1	70631	7,67
5,0	310	250	1	69445	8,47
5,0	360	300	1	70633	13,32
5,0	460	400	1	70634	23,06
5,5	110	50	1	23976	3,53
5,5	160	100	1	23977	4,44
5,5	210	150	1	70636	7,28
5,5	260	200	1	69446	9,44
5,5	310	250	1	70637	11,09
6,0	110	50	1	30248	3,12
6,0	160	100	1	18538	3,60
6,0	210	150	1	30249	5,96
6,0	260	200	1	30251	7,66
6,0	310	250	1	70639	11,97
6,0	460	400	1	69448	16,02
6,5	110	50	1	23978	3,58
6,5	160	100	1	23979	4,20
6,5	260	200	1	59957	9,09
7,0	110	50	1	30252	4,52
7,0	160	100	1	30253	4,84
7,0	210	150	1	68614	6,14
7,0	250	200	1	19592	8,71
8,0	110	50	1	30254	3,77
8,0	160	100	1	18540	3,95
8,0	210	150	1	30255	5,38
8,0	260	200	1	30256	7,64
8,0	460	400	1	30257	16,02
8,0	1000	950	1	70030	55,45

D mm	L mm	I mm		Nº Art.	€
9,0	160	100	1	11518	6,01
9,0	210	150	1	11519	6,55
10,0	110	50	1	30261	4,51
10,0	160	100	1	30262	5,05
10,0	210	150	1	18541	6,07
10,0	260	200	1	30263	8,93
10,0	310	250	1	30264	10,36
10,0	450	400	1	30266	16,76
10,0	600	550	1	30267	23,47
10,0	800	740	1	70640	36,34
10,0	1000	950	1	69911	56,08
11,0	160	100	1	11520	6,63
11,0	210	150	1	25600	6,71
11,0	260	200	1	11521	10,27
12,0	160	100	1	30270	5,36
12,0	210	150	1	30271	6,79
12,0	260	200	1	30273	9,66
12,0	310	250	1	42771	13,02
12,0	450	400	1	30414	15,34
12,0	600	550	1	30275	24,30
12,0	800	750	1	69916	39,43
12,0	1000	950	1	30269	58,05
13,0	160	100	1	30276	6,40
13,0	210	150	1	74789	10,01
13,0	310	250	1	30278	12,58
13,0	450	400	1	55407	20,73
14,0	160	100	1	30280	7,38
14,0	210	150	1	30281	10,77
14,0	260	200	1	42772	12,92
14,0	310	250	1	30283	13,63
14,0	450	400	1	30284	17,92
14,0	600	550	1	30285	26,61
14,0	1000	950	1	30279	63,10

D mm	L mm	I mm		Nº Art.	€
15,0	160	100	1	30286	10,25
15,0	210	150	1	69917	12,50
15,0	260	200	1	42773	13,37
15,0	450	400	1	70642	22,38
16,0	160	100	1	30291	10,25
16,0	210	150	1	30292	12,50
16,0	260	200	1	42774	13,48
16,0	310	250	1	30294	14,42
16,0	450	400	1	30295	21,31
16,0	600	550	1	30296	28,63
16,0	800	750	1	30298	46,87
16,0	1000	950	1	30290	71,65
18,0	200	150	1	30300	16,05
18,0	300	250	1	30413	21,34
18,0	450	400	1	30303	24,33
18,0	1000	950	1	30299	73,67
20,0	200	150	1	30306	22,31
20,0	300	250	1	30309	25,04
20,0	450	400	1	30311	31,59
20,0	600	550	1	30312	46,87
20,0	1000	950	1	30305	74,72
22,0	250	200	1	30314	28,66
22,0	450	400	1	30317	39,91
22,0	600	550	1	23980	47,78
22,0	1000	950	1	23986	75,42
24,0	250	200	1	30319	33,44
24,0	450	400	1	30322	43,40
25,0	250	200	1	30324	36,21
25,0	450	400	1	30327	46,41
25,0	1000	950	1	23987	83,31
26,0	250	200	1	11522	45,36
26,0	450	400	1	30330	51,22

Línea 1m
1890

BROCA-MARTILLO SDS PLUS

SDS plus Rotary Hammer Drill Bit
Foret percussion SDS plus



∅	5	6	7	8	10	5	6	7	8	10	12	14	6	8	10	12	14	8	16
	L110	L110	L110	L110	L110	L160	L160	L160	L160	L160	L160	L160	L210	L210	L210	L210	L210	L260	L260
Pcs	5	5	3	5	3	5	5	3	3	3	3	3	3	3	3	3	3	2	2

Ref. 4995 - Nº Art. 71017: 341,61 €



Clip Euro Hanger ref. M890 pag. 374

Display
01

BROCA-MARTILLO SDS PLUS 1

SDS plus Rotary Hammer Drill Bit 1
Foret percussion SDS plus 1



∅	18	20	22	24	25	8	10	12		
	L300	L300	L250	L250	L250	L460	L450	L450		
Pcs	1	1	1	1	1	2	2	2		
∅	6	8	10	12	14	16	18	20		
	L210	L210	L210	L210	L210	L210	L200	L200		
Pcs	3	3	3	3	3	1	1	1		
∅	4	5	6	7	8	10	5	6	7	8
	L110	L110	L110	L110	L110	L110	L160	L160	L160	L160
Pcs	5	5	5	3	5	3	5	5	3	3

Ref. 4995 - Nº Art. 22182: 558,72 €

Display
02

BROCA-MARTILLO SDS PLUS 2

SDS plus Rotary Hammer Drill Bit 2
Foret percussion SDS plus 2



∅	14	16	18	20	22	24	25	26
	L450	L450	L450	L450	L450	L450	L450	L450
Pcs	3	1	1	1	1	1	1	1
∅	6	8	10	12	10	13	14	16
	L260	L260	L260	L260	L310	L310	L310	L310
Pcs	3	3	3	3	3	2	2	2
∅	9	10	11	12	13	14	15	16
	L160	L160	L160	L160	L160	L160	L160	L160
Pcs	2	2	2	3	3	3	2	2

Ref. 4995 - Nº Art. 22183: 659,72 €

Display 45

BROCA-MARTILLO SDS PLUS BÁSICO

Basic SDS plus Rotary Hammer Drill Bit
Foret percussion SDS plus Essentiel



∅	12 L260	14 L310	16 L310	8 L460	10 L450	12 L450	14 L450	16 L450		
Pcs	3	2	2	1	1	2	1	1		
∅	14 L160	16 L160	6 L210	8 L210	10 L210	12 L210	14 L210	10 L260		
Pcs	3	2	5	3	3	3	3	3		
∅	4 L110	5 L110	6 L110	8 L110	10 L110	5 L160	6 L160	8 L160	10 L160	12 L160
Pcs	5	5	5	5	5	5	5	5	4	3

Ref. 4995 - N° Art. 55614: 561,14 €

Display 25



31
cm

∅	4 L110	5 L110	6 L110	7 L110	8 L110	10 L110	5 L160	6 L160	7 L160	8 L160
Pcs	5	5	5	3	5	3	5	5	3	3

Ref. 4995 - N° Art. 22278: 161,97 €

Display 26



31
cm

∅	9 L160	10 L160	11 L160	12 L160	13 L160	14 L160	15 L160	16 L160
Pcs	2	2	2	3	3	3	2	2

Ref. 4995 - N° Art. 22604: 133,83 €

Display 27



∅	6	8	10	12	14	16	18	20
	L210	L210	L210	L210	L210	L210	L200	L200
Pcs	3	3	3	3	3	1	1	1

Ref. 4995 - N° Art. 22605: 155,83 €

Display 28



∅	6	8	10	12	10	13	14	16
	L260	L260	L260	L260	L310	L310	L310	L310
Pcs	3	3	3	3	3	2	2	2

Ref. 4995 - N° Art. 22609: 213,98 €

Display 29



∅	18	20	22	24	25	8	10	12
	L300	L300	L250	L250	L250	L460	L450	L450
Pcs	1	1	1	1	1	2	2	2

Ref. 4995 - N° Art. 22612: 240,91 €

Display 30



∅	14	16	18	20	22	24	25	26
	L450	L450	L450	L450	L450	L450	L450	L450
Pcs	3	1	1	1	1	1	1	1

Ref. 4995 - N° Art. 22614: 311,92 €





Ref. **1899**

BROCA-MARTILLO SDS PLUS

SDS plus Rotary Hammer Drill Bit
Foret percussion SDS plus



D mm	L mm	I mm		Nº Art.	€ 1 ud.
5	110	50	10	18706	2,89
5	160	100	10	18707	3,76
6	110	50	10	18710	2,97
6	160	100	10	18712	3,42
6	210	150	10	18714	5,66
7	160	100	10	74777	4,00
8	110	50	10	18715	3,58
8	160	100	10	18716	3,75
8	210	150	10	18717	5,12

D mm	L mm	I mm		Nº Art.	€ 1 ud.
10	110	50	10	18719	4,27
10	160	100	10	18721	4,80
10	210	150	10	18722	5,78
12	160	100	10	18723	5,10
12	210	150	10	18724	6,46
13	160	100	10	74778	6,08
13	210	150	10	74780	9,51
14	160	100	10	74782	7,01
14	210	150	10	74783	10,23



Ref. **1494**

4 Pcs

Cont. Ø	Nº Art.	€
5x110 6x110 8x160 10x160 mm	11528	18,98

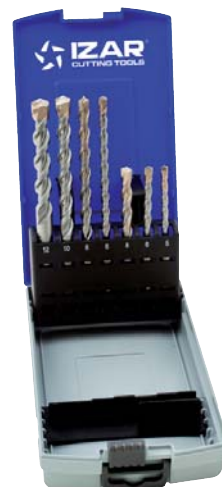

Ref. **1497**

7 Pcs

Cont. Ø	Nº Art.	€
5-6-8 x 110 + 6-8-10-12 x 160 mm	11529	27,91

Línea 33 cm
14S2

SETS BROCAS HORMIGÓN, PARED PRO, PARED

Concrete, Masonry Sets
Jeux béton, maçonnerie



26 cm

	Hormigón Concrete Béton	Pared Pro Concrete Béton	Pared Masonry Maçonnerie
Ref.	1494	1487	1488
Diam	5/6x110 + 8/10x160 mm	3-4-5-6-7-8-9-10 mm	3-4-5-6-7-8-9-10 mm
Pcs.	3	5	5

Ref. 4995 - Nº Art. 72194: 230,49 €

Ref. **1695**

CORONA LIGERA PARED PROFESIONAL

Professional Concrete Light Hollow Core Bit
Trépan béton professionnel



Diente MD
Carbide Tipped
Dent Carbure



SDS plus

Rosca Interna M-16
M-16 Internal Thread
Filetage Intérieur M-16



Hormigón
Concrete
Béton

Hormigón Bloque
Concrete Block
Parpaing

Ladrillo
Brick
Brique



- Más robusta
- Nueva geometría de canales mejorada

- Now Stronger
- New improved channel geometry

- Plus robuste
- Nouvelle géométrie améliorée des goujures

D mm	L mm	Nº Art.	€	D mm	L mm	Nº Art.	€	D mm	L mm	Nº Art.	€
30	50	13898	45,34	50	50	13902	67,56	82	50	19032	92,47
35	50	13899	53,68	65	50	13904	70,68	90	50	25207	94,63
40	50	13900	61,54	68	50	19012	74,23	100	50	25208	109,26
45	50	13901	64,80	80	50	19014	74,23				

* Accesorios no incluidos / Accessories not included / Accessoires non inclus

Ref. **1696**



Broca Centrar
Center Drill / Foret à Centrer



00001

Broca Drill Bit Mod.	D mm	L mm	Nº Art.	€
1	8	120	18857	8,80

Husillo SDS plus
SDS plus Spindle / Arbre SDS plus



00003-5

SDS plus Mod.	L mm	Nº Art.	€
3	105	18858	24,99
4	220	19021	33,25
5	370	19023	47,24

Husillo Hex
Hex Spindle / Arbre Hex



00006-8

HEX Mod.	L mm	Nº Art.	€
6	100	19018	22,02
7	220	19026	28,85
8	370	19030	38,64

Display
05

CORONA LIGERA PARED PROFESIONAL

Professional Concrete Light Hollow Core Bit
Trépan béton professionnel



Ø	SDS plus L110	SDS plus L110	SDS plus L220	SDS plus L350
Pcs	1	1	2	1
Ø	40	50	50	Broca Drill Bit Foret
Pcs	1	1	1	2 1
Ø	65	68	80	82
Pcs	1	1	1	1

Ref. 4995 - Nº Art. 22418: 698,43 €

HERRAMIENTAS SDS MAX

SDS max Tools
Outils SDS max

Ref. **1892**

BROCA-MARTILLO SDS MAX 4 PUNTAS

4-Cutter SDS max Rotary Hammer Drill Bit
Foret percussion SDS max 4 pointes



SDS max

Marca desgaste
Wear Marking
Témoïn d'usure

Hormigón Reforzado
Reinforced Concrete
Béton armé

Hormigón Concrete
Béton

Hormigón Bloque
Concrete Block
Parpaing



2 puntas / 2-Cutter / 2-Taillants:

D mm	L mm	I mm	Nº Art.	€
12	340	200	30332	43,17
12	540	400	30333	50,63
12	690	550	30334	76,91
14	340	200	30335	46,70
14	540	400	30336	53,30
15	340	200	30337	50,46
15	540	400	30338	56,68

4 puntas / 4-Cutter / 4-Taillants:

D mm	L mm	I mm	Nº Art.	€
16	340	200	30339	55,25
16	540	400	30340	63,24
16	940	800	60065	106,19
16	1320	1180	60066	203,36
18	340	200	30341	56,68
18	540	400	30342	69,29
18	940	800	60068	106,30
18	1320	1180	60070	209,67
20	320	200	30343	57,57
20	520	400	30344	74,60
20	920	800	30345	106,41
20	1320	1200	60072	251,20
22	320	200	30346	65,91
22	520	400	30347	78,33
22	920	800	30348	115,48
22	1320	1200	60075	268,41
24	320	200	30349	68,22
24	520	400	30350	83,85
25	320	200	30351	70,18
25	520	400	30352	85,28
25	920	800	30353	126,66
25	1320	1200	60077	273,51
26	520	400	30354	86,88
28	370	250	30355	84,57
28	570	450	30356	94,34
28	670	550	30357	116,54

D mm	L mm	I mm	Nº Art.	€
28	920	800	60079	140,51
30	370	250	30358	92,20
30	570	450	30359	98,24
32	370	250	30360	95,93
32	570	450	30361	119,55
32	920	800	30362	164,68
32	1320	1200	60085	291,55
35	370	250	30363	106,58
35	570	450	30364	127,74
35	670	550	30365	150,83
35	920	800	38103	178,84
37	370	250	60088	112,21
37	570	450	60089	129,62
37	920	800	60090	191,21
38	370	250	30366	123,83
38	570	450	30367	131,47
38	720	600	79736	191,27
38	920	800	79737	202,30
40	370	250	30368	135,01
40	570	450	30369	154,56
40	920	800	30370	211,41
40	1320	1200	60093	335,88
45	570	450	30371	222,05
45	920	800	23981	305,68
50	570	450	52952	246,40
52	570	450	52954	299,62

Línea 1m
1892

BROCA-MARTILLO SDS MAX 4 PUNTAS

4-Cutter SDS max Rotary Hammer Drill Bit
Foret percussion SDS max 4 pointes



Ø	16 L340	16 L540	18 L340	18 L540	20 L320	20 L520	22 L320	22 L520	25 L320	25 L520	28 L370	28 L570	30 L370	30 L570	32 L570	35 L570
Pcs	1	1	1	1	1	1	1	1	1	1	1	1	1	1	1	1

Ref. 4995 - Nº Art. 72141: 1.382,87 €

Display 03

BROCA-MARTILLO SDS MAX 4 PUNTAS

4-Cutter SDS max Rotary Hammer Drill Bit
Foret percussion SDS max 4 pointes



∅	16	18	20	22	25	28	30	32	35
	L540	L540	L520	L520	L520	L570	L570	L570	L570
Pcs	1	1	1	1	1	1	1	1	1

∅	12	14	16	18	20	22	25	28	30
	L340	L340	L340	L340	L320	L320	L320	L370	L370
Pcs	1	1	1	1	1	1	1	1	1

Ref. 4995 - N° Art. 22315: 1.382,87 €

Display 33



49
cm

Display 34



68
cm

∅	12	14	16	18	20	22	25	28	30
	L340	L340	L340	L340	L320	L320	L320	L370	L370
Pcs	1	1	1	1	1	1	1	1	1

Ref. 4995 - N° Art. 22618: 572,24 €

∅	16	18	20	22	25	28	30	32	35
	L540	L540	L520	L520	L520	L570	L570	L570	L570
Pcs	1	1	1	1	1	1	1	1	1

Ref. 4995 - N° Art. 22619: 810,62 €

Ref. **1894**

CORONA SDS MAX

SDS max Core Cutter
Foret trépan SDS max

¡NUEVO MODELO MEJORADO!

New improved model!
Nouveau modèle amélioré !



SDS
max



Nuevo Diseño Especial Hormigón Reforzado
New Special Design for Reinforced Concrete
Nouveau dessin pour béton armé

Hormigón
Concrete
Béton

Hormigón Bloque
Concrete Block
Parpaing

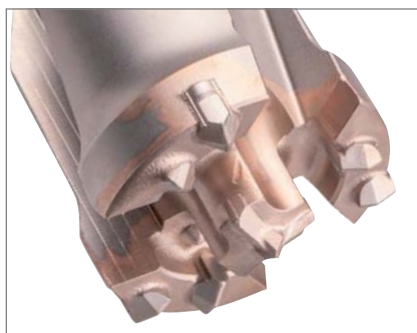

- Taladrado Exacto Auto-Centrante
- Dientes MD ► Rápida Penetración
- Gran Volumen Canales ► Mayor Evacuación del Polvo

- Auto-Centering Accurate Drilling
- Carbide Teeth ► Fast Penetration
- High Volume Flutes ► Better Dust-Removal

- Perçage autocentreur exact
- Dents carbure ► Pénétration plus rapide
- Gran volume des goujures ► Meilleur évacuation copeaux

- Resistente al calentamiento.
- Apto para trabajo intensivo

- Heat-resistant.
- Intensive work.

- Resistance au rechauffement
- Idéal pour travaux intensifs.

D mm	L mm	I mm	Nº Art.	€
45	550	450	16864	302,39
45	990	890	16865	365,36
55	550	450	16868	349,42
55	990	890	16869	400,56
65	550	450	16870	376,72
65	990	890	16871	433,51
80	550	450	16873	419,73
80	990	890	16874	541,17

Ref. **1697**

CORONA PERFORADORA TALADRO PERCUTOR

Tapered Hollow Hammer Core Bit

Trépan pour perceuses percussion lourds



Diente MD
Carbide Tipped
Dent Carbure



SDS
max

Conicidad 1:8
1:8 Tapered
Conicité 1:8

Hormigón
Concrete
Béton



D mm	L mm	Nº Art.	€
40	100	19035	108,63
50	100	19041	131,46
65	100	19045	169,29
80	100	19047	194,28
90	100	19048	223,84
100	100	19050	242,93
125	100	19051	317,63

* **Accesorios no incluidos**
Accessories not included
Accessoires non inclus



Ref. **1698**



Broca Centrar
Center Drill
Foret à centrer



00001

Broca Drill Bit Foret Mod.	D mm	L mm	Nº Art.	€
1	11	120	19054	9,24

Cuña Expulsora Ref. 1104
Drill Drift
Chasse



00002

CM min.	CM max.	L mm	Nº Art.	€
1	2	116	16436	11,23

Husillo SDS max
SDS max Spindle
Arbre SDS max



00003-4

SDS max Mod.	L mm	Nº Art.	€
3	180	19057	50,28
4	450	19058	89,34

**Display
06**

CORONA PERFORADORA TALADRO PERCUTOR

Tapered Hollow Hammer Core Bit

Trépan pour perceuses percussion lourds



	Llave Key / Clé	Broca Drill Bit / Foret	Broca Drill Bit / Foret	SDS max L180	SDS max L180	SDS max L450
ø	3	2	1	2	1	1
Pcs						
ø	40	50	65	80		
Pcs	1	1	1	1		

Ref. 4995 - Nº Art. 22463: **905,23 €**

ADAPTADOR iCONNECT

iConnect Adaptor Adaptateur iConnect

Descripción

iConnect permite taladrar agujeros extremadamente profundos con una broca-martillo corta, de una manera mucho más económica gracias a su sistema de adaptadores y alargadores.

Estos alargadores permiten incluso la combinación de un taladro SDS plus con una broca SDS max.

Ventajas

- 2 clicks y ya tiene la broca de la longitud que necesita
- Las dos entradas SDS max del adaptador consiguen una conexión rápida y segura entre la broca y los diferentes alargadores
- Con el adaptador iConnect no hay pérdida de energía, algo habitual en otros sistemas tradicionales de adaptadores
- No hay posibilidad de rotura por causa de una excesiva presión en el área de unión
- Reducción al mínimo de las herramientas necesarias para el taladrado profesional

Uso

Hormigón, pared y piedra natural

Description

iConnect allows drilling extremely deep holes with a short hammer drill bit, in very inexpensive way thanks to this system of adaptors and extensions.

These extensions allow even the combination of a SDS plus drilling machine with a SDS max rotary hammer drill bit.

Advantages

- 2 clicks and the tools is the required length
- The adaptor's two SDS max chucks provide a quick and safe connection between the drilling tool and the extension shanks
- With the iConnect adaptor there is no energy loss, normally encountered in traditional adapter systems
- Breakages because of excessive strain in the coupling area are not possible
- Professional drilling tool requirements reduced to a minimum

Use

Concrete, masonry and natural stone

Description

IConnect permet percer des trous très profonds avec un foret percussion court, d'une façon beaucoup plus économique grâce à son système d'adaptateurs et rallonges.

Ces rallonges permettent aussi une combiner un perçage SDS PLUS avec un foret SDS Max.

Avantages

- En 2 clicks vous obtenez la longueur du foret que vous avez besoin.
- Les 2 entrées SDS MAX de l'adaptateur vous permettent une connexion rapide entre le foret et les différents rallonges.
- Avec l'adaptateur IConnect pas de perte d'énergie, comme dans d'autres systèmes.
- Pas de rupture à cause d'une haute pression dans la zone de la conéxion d'union.
- Réduire au minimum les outils pour le perçage professionnel.

Emploi

Béton Armé, Béton et Pierre.

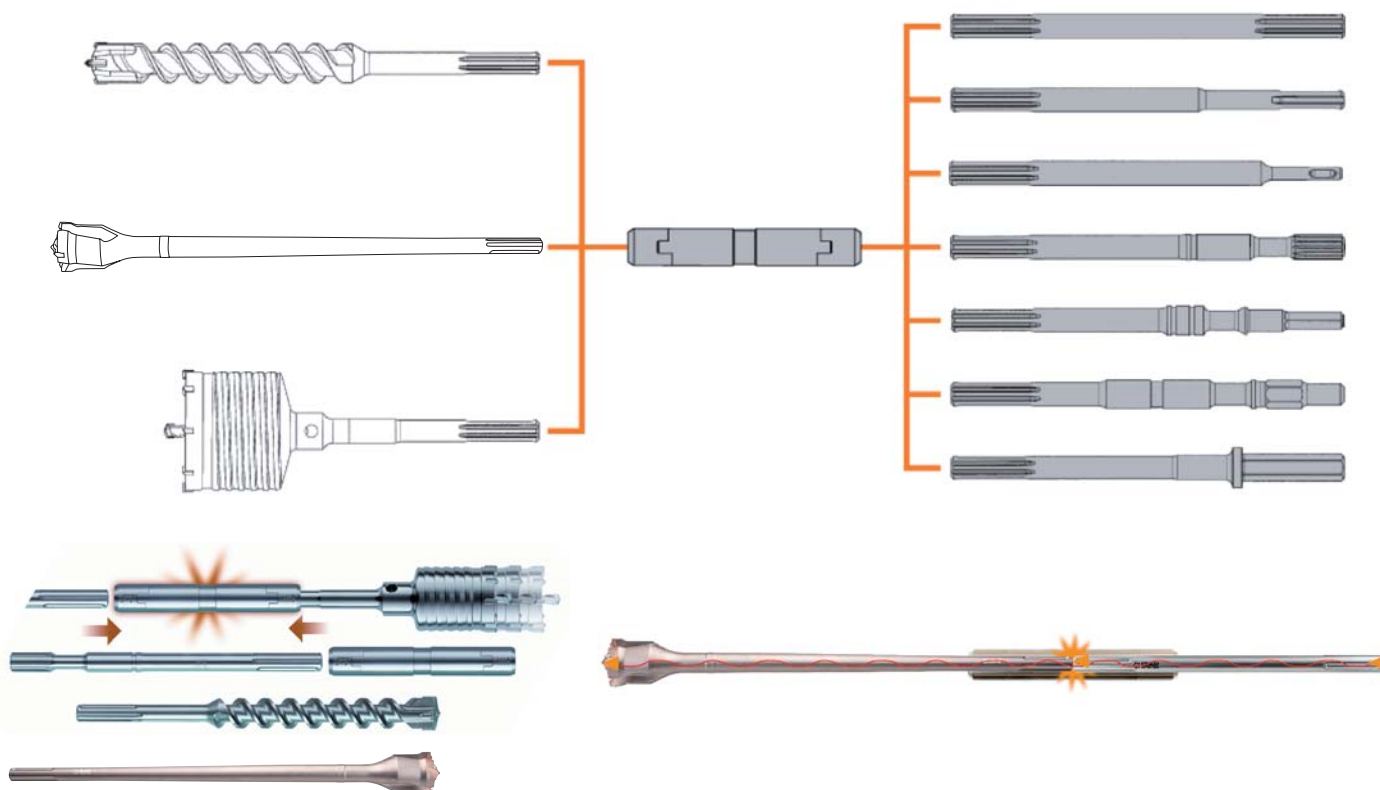

Ref. **1875**

ADAPTADOR SDS MAX

SDS max Adaptor
Adaptateur SDS max



SDS
max



Hormigón
Concrete
Béton

Hormigón Bloque
Concrete Block
Parpaing



Adaptador Mod.	L mm	d mm	Nº Art.	€
1	190	30	56810	236,96



Extensión MAX-MAX Mod.	L mm	Nº Art.	€
0320-MAX	320	56811	39,96
0750-MAX	750	56812	50,12
1100-MAX	1100	56813	67,61



Extensión MAX-PLUS	L mm	Nº Art.	€
0320-PLUS	320	56814	43,94
0750-PLUS	750	56815	55,93

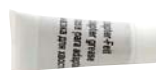

Grasa Grease / Graisse Mod.	Nº Art.	€
2	57504	5,84

CINCELES

Chisels

Burins

Ref. **1870**

CINCEL SDS PLUS

SDS plus Chisel

Burin SDS plus



SDS plus

Hormigón Reforzado
Reinforced Concrete
Béton armé

Hormigón
Concrete
Béton



	Mod.	Tipo Type / Type	L mm	I mm	Nº Art.	€
 Puntero / Pointed / Ciseau	00001-250	Puntero / Pointed / Ciseau	250		30372	7,36
 Plano / Flat / Plate	00002-250	Plano / Flat / Plate	250	20	30373	7,36
 Ancho / Wide / Large	00003-200038	Ancho / Wide / Large	200	38	30374	12,60
 Hueco / Hollow / Gouge	00004-240	Hueco / Hollow / Gouge	240	22	30375	15,20
 Alas / Wing-Canal / Ailes	00005-250	Alas / Wing-Canal / Ailes	250	22	54983	36,75
 Azulejo / Tile / Carreau	00009-200038	Azulejo Tile / Carreau	200	38	54985	14,42
	00009-250060		250	60	54986	36,98
 Dentado / Slotting / Denté	00010-200032TCT	Dentado / Slotting / Denté	200	32	54988	98,02
 Ancho / Wide / Large	00011-250040	Ancho / Wide / Large	250	40	82692	16,38

Reafilable
Resharpenable
Réaffûtable

Ref. **1872**

CINCEL SDS MAX

SDS max Chisel
Burin SDS max



SDS
max

Hormigón Reforzado
Reinforced Concrete
Béton armé

Hormigón
Concrete
Béton



Puntero / Pointed / Ciseau



Plano / Flat / Plate



Ancho / Wide / Large



Hueco / Hollow / Gouge



Alas / Wing-Canal / Ailes



Acanalador / Canal / Gouge-Brique



Azulejo / Tile / Carreau



Dentado / Slotting / Denté



Pala / Clay-Spade / Pelle

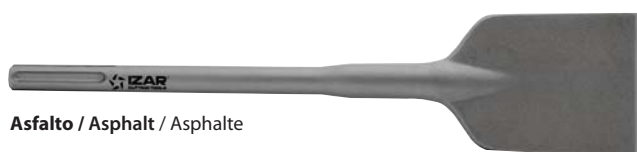

Asfalto / Asphalt / Asphalte



Abujardar / Bushing / Bouchardage

Mod.	Tipo Type / Type	L mm	I mm	Nº Art.	€
00001-280	Puntero Pointed / Ciseau	280		54989	10,52
00001-400		400		30376	12,47
00001-600		600		23036	16,80
00002-280	Plano Flat / Plate	280	24	54990	10,52
00002-400		400	24	30377	12,47
00002-600		600	24	23037	16,80
00003-360050	Ancho Wide / Large	360	50	23038	18,55
00003-300080		300	80	30378	27,85
00003-350115		350	115	54991	56,91
00004-300	Hueco Hollow / Gouge	300	26	30379	30,92
00005-380035	Alas Wing-Canal / Ailes	380	35	18186	68,51
00008-300032	Acanalador Canal / Gouge-Brique	300	32	54993	34,30
00009-300050	Azulejo Tile / Carreau	300	50	54994	29,47
00009-300080		300	80	54996	30,92
00010-280038TCT	Dentado Slotting / Denté	280	38	54999	91,75
00011-400110	Pala Clay-Spade / Pelle	400	110	55000	74,91
00012-400090	Asfalto Asphalt / Asphalte	400	90	55003	72,35
00013-240045	Abujardar Bushing Bouchardage	240	45x 45	55004	118,22



Línea 33 cm
1870

CINCEL SDS PLUS

SDS plus Chisel
Burin SDS plus



	Puntero Pointed Ciseau	Plano Flat Plate	Ancho Wide Large	Hueco Hollow Gouge
∅				
Pcs	2	2	2	2

Ref. 4995 - Nº Art. 71023: **85,03 €**

Display
04

CINCELES SDS MAX / PLUS

SDS max / plus Chisels
Burins SDS max / plus



SDS MAX Ref. 1872

	Puntero Pointed Ciseau L400	Plano Flat Plate L400	Ancho Wide Large 50	Ancho Wide Large 80	Hueco Hollow Gouge	Alas Wing-Canal Ailes L380	Puntero Pointed Ciseau L600	Plano Flat Plate L600
∅								
Pcs	2	2	2	2	2	2	1	1

Display
35

Ref. 4995
Nº Art. 22621
375,08 €

SDS PLUS Ref. 1870

	Puntero Pointed Ciseau	Puntero Pointed Ciseau	Plano Flat Plate	Plano Flat Plate	Ancho Wide Large	Ancho Wide Large	Hueco Hollow Gouge	Hueco Hollow Gouge
∅								
Pcs	1	1	1	1	1	1	1	1

Display
36

Ref. 4995
Nº Art. 22623
85,03 €

Ref. 4995 - Nº Art. 22289: **460,10 €**

Ref. **1871**

CINCEL HEXAGONAL 30 mm *

HEX Shank Chisel *

Burin hexagonal *

New!



Hormigón Reforzado
Reinforced Concrete
Béton armé

Hormigón
Concrete
Béton

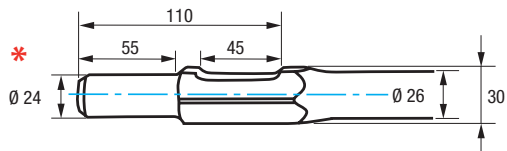

* **Mango rebajado**
Reduced Shank
Queue reduite $\varnothing 24 \times 55 \text{ mm}$



Puntero / Pointed / Ciseau



Plano / Flat / Plate

Mod.	Tipo Type / Type	L mm	I mm	Nº Art.	€
00001-400	Puntero / Pointed / Ciseau	400		70710	34,99
00002-400	Plano / Flat / Plate	400	75	70712	62,94



BROCAS MANGO CILÍNDRICO

Straight Shank Drill Bits
Forets queue cylindrique

Ref. **1882**

BROCA PORCELÁNICO

PORCELAIN Drill Bit
Foret PORCELAINE

¡MODELO EXCLUSIVO!



Video



Sin percusión
No percussion
Sans percussion



H₂O
Refrigerar punta
Point Cooling
Refroidir la pointe



Porcelánico
Porcelain
Porcelaine

Teja, piedra, pizarra, cemento, terrazo, mármol, terracota, calizas
Tile, quarry, slate, cement, terrazzo, marble, terracotta, limestones
Tuile, pierre, ardoise, ciment, terrazzo, marbre, terre cuite, calcaires



D mm	L mm	l mm	d mm		Nº Art.	€
3,00	85	50	3,0	1	13903	12,34
3,50	85	50	3,0	1	13906	12,34
4,00	85	50	3,5	1	13909	12,34
4,50	85	50	4,0	1	13910	12,34
5,00	85	50	4,5	1	14030	13,05
6,00	100	65	5,5	1	14036	13,66
7,00	125	75	6,5	1	14061	15,62
8,00	125	75	7,5	1	14062	16,92
9,00	150	90	8,5	1	14063	20,53
10,00	150	90	9,5	1	14066	20,53
11,00	150	90	10,0	1	14068	22,74
New! 12,00	150	90	10,0	1	56521	22,74



Doble Blister
ref. M882
pag. 375



Ref. **1482**

4 Pcs

Cont. Ø	Nº Art.	€
4-5-6-8 mm	31004	57,64



Display
1882

Display Sobremesa
Table Display
Pres. Comptoir

Display
37



29
cm

ø	3	4	5	5	6	6	7	8	8	9	10
Pcs	4	4	5	5	5	5	4	2	2	4	4

Ref. 1882 - Nº Art. 22661: 660,25 €

ø	4	4	5	5	6	6	8	8	10	10
Pcs	2	2	2	2	2	2	2	2	2	2

Ref. 4995 - Nº Art. 22620: 306,01 €

Display especial Porcelánico

Display
70

BROCA, BROCA-CORONA, CORONA DIAMANTE PORCELÁNICO

Porcelain Diamond Core Bit & Drill Bit

Foret, Foret-Trépan et Trépan Diamant PORCELAINE



Ref. 1882	∅	4	5	5	6	6	8	8	10
	Pcs	2	3	2	5	5	3	2	2
Ref. 1879	∅	5	6	6	8	8	10	12	14
	Pcs	5	3	3	2	2	2	1	1
Ref. 1883	∅	6	8	10	20	25	32	35	
	Pcs	1	1	1	1	1	1	1	1

Ref. 4995 - Nº Art. 82239: 1.078,50 €

Ref. 1879

BROCA-CORONA DIAMANTE PORCELÁNICO

Porcelain Diamond Core Bit

Foret-Trépan diamant PORCELAINE



H₂O
Refrigerar punta
Point Cooling
Refroidir la pointe



Porcelánico
Porcelain
Porcelaine

Uso / Use / Usage

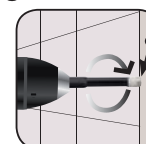
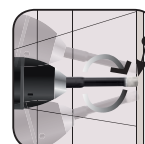
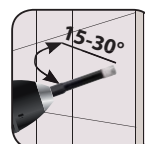

D	d	L	l		Nº	€
mm	mm	mm	mm		Art.	
5,00	8,30	68	10	1	56664	14,82
6,00	8,30	68	10	1	56665	15,51
8,00	8,30	80	10	1	56667	19,22
10,00	8,30	80	10	1	56668	23,31
12,00	8,30	80	10	1	56670	25,82
14,00	8,30	80	10	1	56671	29,85



Set 5 Pcs

Cont. ∅	Nº Art.	€
5-6-8-10-12 mm	57448	98,68

Línea 33 cm
1879

BROCA-CORONA DIAMANTE PORCELÁNICO

Porcelain Diamond Core Bit

Foret-Trépan diamant PORCELAINE



∅	5	6	8	10	12	14
	Pcs	3	3	3	3	3

Ref. 4995 - Nº Art. 71026: 385,62 €

Ref. **1883**

CORONA DIAMANTE PORCELÁNICO

Porcelain Diamond Core Bit
Trépan diamant PORCELAINE

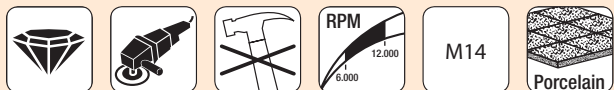

Porcelánico
Porcelain
Porcelaine



Video

Aplicación

Taladrado limpio de agujeros exactos en placas de piedra, azulejos, cerámicas, dekon y piedra artificial dura. Especial para Porcelánico.

Atención

Comenzar a taladrar con cuidado por un lado y redirigir poco a poco hacia un taladrado completo.

Consejo

Puede conseguir un mejor rendimiento con leves movimientos oscilantes a la corona mientras corta.

Application

Clean drilling of exact and Sharp holes in stone plates, tiles, ceramics, dekon and hard artificial stone. Special for Porcelain.

Please note

Start drilling carefully edgewise and slowly continue with full drilling.

Tip

With small tilting movements of the core drill the cutting performance can be improved.

Application

Perçage trous précision sur tôles pierre, carreaux de faïence, céramiques et dekon. Spécial pour porcelaine.

Attention

Commencer à percer doucement et rediriger petit à petit vers un perçage complet.

Conseil

Vous pouvez avoir une meilleure performance avec faibles mouvements variables sur le trépan dans la coupe.

Diámetros más usuales

35 mm: Grifería
40 mm: Desagües electrodomésticos
50 mm: Desagües industriales
60 mm: Cajas eléctricas

Most usual diameters

35 mm: Water Taps
40 mm: Appliances Pipes
50 mm: Industrial Pipes
60 mm: Electrical Boxes

Diamètres plus usuels

35 mm: Robinetterie
40 mm: Déversoirs ménage
50 mm: Déversoirs industriels
60 mm: Boîtes électriques

D mm	L mm	Rosca Thread Filet	Nº Art.	€
6	63	M14	1 34506	36,35
8	63	M14	1 34353	37,38
10	63	M14	1 34507	41,48
12	63	M14	1 34508	45,56
14	63	M14	1 55532	54,79
16	90	M14	1 81515	55,30
18	90	M14	1 55533	55,81
20	90	M14	1 55534	56,83
25	90	M14	1 55535	64,00
32	90	M14	1 55536	71,17

D mm	L mm	Rosca Thread Filet	Nº Art.	€
35	90	M14	1 34510	72,71
40	90	M14	1 34511	84,99
45	90	M14	1 55538	94,21
50	90	M14	1 34512	101,89
55	90	M14	1 55539	107,53
60	90	M14	1 34513	108,05
68	90	M14	1 55541	118,78
75	90	M14	1 34516	131,08
82	90	M14	1 55542	142,86
110	90	M14	1 69797	258,97



Mod. 00021

Husillo Mango Hexagonal disponible en [pag. 82](#)

Hex Shank Spindle available in [page 82](#)

Arbre queue hexagonal disponible à la [pag. 82](#)

Línea 1m
1883

CORONA DIAMANTE PORCELÁNICO

Porcelain Diamond Core Bit
Trépan diamant PORCELAINE



Ø	6	8	10	12	14	18	20	25	32	35	40	45	50
Pcs	1	1	1	1	1	1	1	1	1	1	1	1	1

Ref. 4995 - Nº Art. 72145: **817,19 €**

Ref. **1877**

BROCA GRANITO

Granite Drill Bit
Foret Granite



BlackGranite



Granito
Granite
Granite

Piedra
Stone
Pierre

Mármol
Marble
Marbre

Silestone



Video

- Ideal para piedras de todo tipo hasta granitos de gran dureza.
- Ideal for all types of stones, from general ones to hard granites.
- Idéal pour tous les types de pierres jusqu'aux granites difficiles à percer.

- El uso de refrigeración con agua permite una mayor eficiencia de corte y durabilidad. También apto en seco.
- Better performance and durability if cooled using water when drilling. Dry cutting also possible
- Le refroidissement à eau permet une meilleure efficacité de coupe et une meilleure durabilité. Coupe à sec également possible.

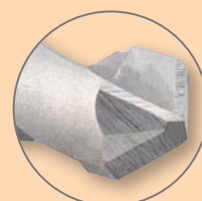

- **Forma de filo asimétrico.**
El rectificado asimétrico de la punta de metal duro reduce la resistencia al corte, permitiendo una perforación del material de trabajo con menor esfuerzo de torsión.
- **Asymmetric cutting edge shape.**
The asymmetric grinding of the carbide tip reduces cutting resistance, allowing the work material drilling with a lower torque.
- **Arête de coupe asymétrique.**
La réctification asymétrique de la pointe en carbure réduit la résistance à la coupure, permettant le perçage du matériau de travail avec une torsion plus faible.

D mm	L mm	l mm	d mm	RPM		Nº Art.	€
3,00	85	50	3,00	2000-2500	1	76539	9,89
3,50	85	50	3,00	2000-2500	1	76540	9,89
4,00	85	50	3,50	2000-2500	1	76543	9,89
4,50	85	50	4,00	2000-2500	1	76544	9,89
5,00	85	50	4,50	2000-2500	1	76545	10,36
6,00	100	65	5,50	1500-2000	1	76547	10,46
7,00	125	75	6,50	1500-2000	1	76548	12,52
8,00	125	75	7,50	1000-1500	1	76549	13,56
9,00	150	90	8,50	1000-1500	1	76550	16,44
10,00	150	90	9,50	1000-1500	1	76553	16,44

Display
69



29
cm

ø	4	4	5	5	6	6	8	8	10	10
Pcs	2	2	3	3	3	3	3	3	2	2

Ref. 4995 - Nº Art. 81880: 311,60 €

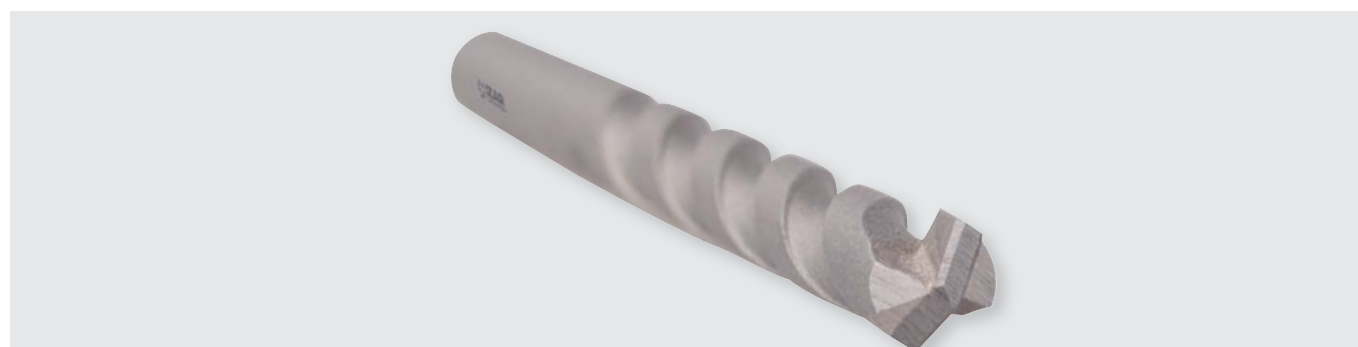

Ref. **1886**

BROCA PUNTA METAL DURO PARED PROFESIONAL

Professional Concrete Carbide Tipped Drill Bit
Foret pointe carbure béton professionnel



MD/HM
TCT



Hormigón
Concrete
Béton

Hormigón Bloque
Concrete Block
Parpaing



D mm	L mm	I mm		Nº Art.	€
3,0	60	35	1	30232	1,96
4,0	75	45	1	18525	1,96
5,0	85	40	1	18526	1,99
5,5	85	40	1	23983	2,07
6,0	100	55	1	18528	2,15
6,5*	100	55	1	23984	2,34
7,0	100	55	1	18529	2,57
8,0	120	70	1	18531	2,87
9,0	120	70	1	18532	3,60
10,0	120	70	1	18534	3,60
11,0	150	90	1	17858	4,63
12,0	150	90	1	18535	5,41
13,0	150	90	1	30234	6,76
14,0	150	90	1	18537	7,97
16,0	150	90	1	30235	14,52

D mm	L mm	I mm		Nº Art.	€
5,0	150	80	1	30176	2,76
6,0	150	80	1	30200	3,38
8,0	200	130	1	30208	5,23
10,0	200	130	1	30214	6,44
12,0	200	130	1	30222	6,57



* Diam. hasta fin de existencias / while stock lasts / jusqu'à la fin de stock

Línea 1m
1886

BROCA PUNTA METAL DURO PARED PROFESIONAL

Professional Concrete Carbide Tipped Drill Bit
Foret pointe carbure béton professionnel



Ø	3	4	5	6	7	8	9	10	12	14	16
Pcs	10	10	10	10	10	10	10	10	10	10	10

Ref. 4995 - Nº Art. 71100: 486,25 €



Ref. **1846**

BROCA PUNTA METAL DURO PARED PRO EXTRA LARGA

Extra Long Professional Concrete Carbide Tipped Drill Bit
Foret pointe carbure béton professionnel extra-longue



MD/HM
TCT



Serie Extra Larga
Extra Long Series
Série extra-longue

Hormigón
Concrete
Béton

Hormigón Bloque
Concrete Block
Parpaing



D mm	L mm	I mm		Nº Art.	€
6	400	300	1	30202	6,10
8	400	300	1	30212	6,10
10	400	300	1	30216	6,38
12	400	300	1	30227	6,86
14	400	300	1	30233	8,72
16	400	300	1	30237	15,25
18	400	300	1	30207	19,08
20	400	300	1	30225	21,14
22	400	300	1	16474	24,32
24	400	300	1	16475	25,18
25	400	300	1	16476	28,76

D mm	L mm	I mm		Nº Art.	€
8	600	450	1	76910	9,97
10	600	450	1	30218	10,44
12	600	450	1	30229	11,38
14	600	450	1	30236	13,79
16	600	450	1	30238	17,60
18	600	450	1	16477	23,67
20	600	450	1	16478	27,46

Línea 1m
1846

BROCA PUNTA METAL DURO PARED PRO EXTRA LARGA

Extra Long Professional Concrete Carbide Tipped Drill Bit
Foret pointe carbure béton professionnel extra-longue



ø	6	8	10	12	14	16	18	20	22	24	25	10	12	14	16	18	20
	L400	L400	L400	L400	L400	L400	L400	L400	L400	L400	L400	L600	L600	L600	L600	L600	L600
Pcs	2	2	2	2	2	2	2	1	1	1	1	2	2	2	2	2	1

Ref. 4995 - Nº Art. 72150: 417,57 €

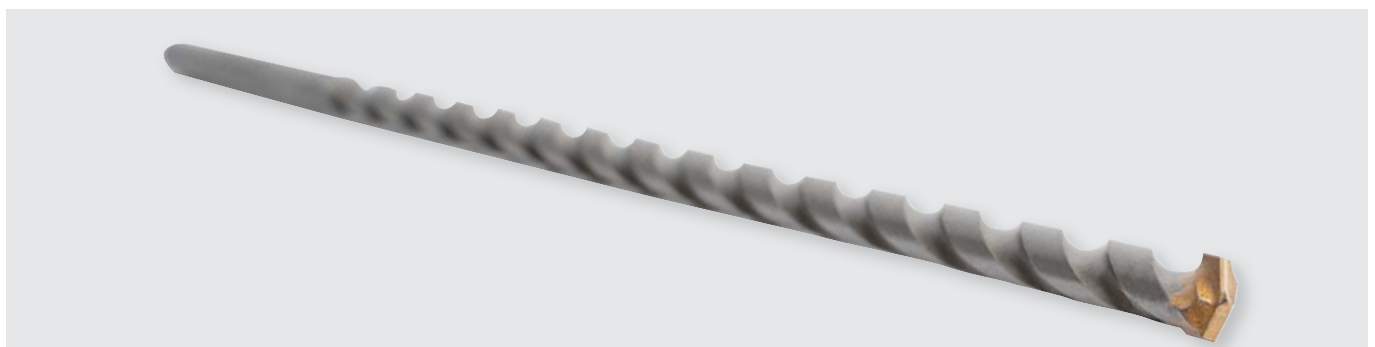

Display 07



BROCA PUNTA METAL DURO PARED PROFESIONAL

Professional Concrete Carbide Tipped Drill Bit
Foret pointe carbure béton professionnel

∅	12 L200	8 L400	10 L400	12 L400	14 L400	16 L400	18 L400	20 L400		
Pcs	3	3	3	3	3	3	2	2		
∅	10 L120	12 L150	14 L150	16 L150	5 L150	6 L150	8 L200	10 L200		
Pcs	5	5	5	5	5	5	5	3		
∅	3 L60	4 L75	5 L85	5 L85	6 L100	6 L100	7 L100	8 L120	8 L120	9 L120
Pcs	10	10	5	5	5	5	5	5	5	

Ref. 4995 - N° Art. 22191: 604,04 €

Display 52 Mixto PRO



BROCAS MULTI INOX + PARED PRO + MADERA PRO

Multi-Stainless + Concrete Pro + Wood Pro Drill Bits
Forets Multi INOX + béton pro + bois pro

Ref. 1886	∅	3	4	5	6	7	8	9	10	12	14
	Pcs	5	5	10	10	5	5	3	3	3	3
Ref. 1641	∅	3	3	4	4	5	5	6	6	8	10
	Pcs	3	2	3	2	3	2	3	2	5	5
Ref. 1004	∅	1	2	3	3,5	4	4,5	5	6	8	10
	Pcs	2	2	3	3	5	5	5	5	5	3

Ref. 4995 - N° Art. 68575: 491,16 €

Display 23



JUEGOS CASSETTE MADERA Y CONSTRUCCIÓN

Wood & Construction Cassette Sets
Jeux cassette bois & construction

Constr. Madera Wood / Bois	Pcs	Ref. 1485 Pared Masonry / Béton 5 Pcs.	Ref. 1486 Pared Pro Masonry Pro / Béton Pro 5 Pcs.	Ref. 1435 Madera Wood / Bois 5 Pcs.	Ref. 1438 Madera Wood / Bois 8 Pcs.
		5	5	5	5
Constr.	Pcs	Ref. 1488 Pared Masonry / Béton 8 Pcs.	Ref. 1487 Pared Pro Masonry Pro / Béton Pro 8 Pcs.	Ref. 1494 SDS plus 4 Pcs.	
		5	5	3	

Ref. 4995 - N° Art. 22372: 419,23 €

Sets 1886

BROCA PUNTA METAL DURO PARED PROFESIONAL

Professional Concrete Carbide Tipped Drill Bit
Foret pointe carbure béton professionnel



Set **1486**

5 Pcs

Cont. Ø	Nº Art.	€
4-5-6-8-10 mm	30220	14,52



Set **1487**

8 Pcs

Cont. Ø	Nº Art.	€
3-4-5-6-7-8-9-10 mm	21653	23,86

Línea 33 cm 14S1

SETS BROCAS METAL, PARED PRO, PARED, MADERA

Metal, Concrete, Masonry, Wood Sets
Jeux métal, béton, maçonnerie, bois



	Metal Metal Métal	Pared Pro Concrete Béton	Pared Masonry Maçonnerie	Madera Wood Bois
Ref	1462-1010	1486	1485	1435
Diam	2-3-4-5-6-8 mmm	4-5-6-8-10 mm	4-5-6-8-10 mm	4-5-6-8-10 mm
Pcs.	5	5	5	5

Ref. 4995 - Nº Art. 72193: **181,05 €**

Línea 33 cm 14S2

SETS BROCAS HORMIGÓN, PARED PRO, PARED

Concrete, Masonry Sets
Jeux Béton, Maçonnerie



	Hormigón Concrete Béton	Pared Pro Concrete Béton	Pared Masonry Maçonnerie
Ref	1494	1487	1488
Diam	5/6x110 + 8/10x160 mm	3-4-5-6-7-8-9-10 mm	3-4-5-6-7-8-9-10 mm
Pcs.	3	5	5

Ref. 4995 - Nº Art. 72194: **230,49 €**

Ref. **1880**

BROCA PUNTA METAL DURO PARED STANDARD

Standard MASONRY Carbide Tipped Drill Bit
Foret pointe carbure MAÇONNERIE standard



MD/HM
TCT



Ladrillo
Brick
Brique

D mm	L mm	I mm	d mm		Nº Art.	€	D mm	L mm	I mm	d mm		Nº Art.	€
3	60	30	2,5	1	18495	0,77	13	150	95	10,0	1	30180	2,92
4	75	40	3,2	1	18496	0,78	14	150	95	10,0	1	18508	3,76
5	85	50	4,0	1	18498	0,88	16	150	95	14,0	1	30184	5,81
6	100	60	4,8	1	18499	0,99	18	160	105	16,0	1	30188	6,64
7	100	60	5,2	1	18501	1,12	20	160	105	18,0	1	30190	8,15
8	120	80	6,2	1	18502	1,23	22	160	105	19,0	1	30192	9,54
9	120	80	7,5	1	18504	1,40	25	160	105	22,5	1	30194	11,80
10	120	80	7,5	1	18505	1,51							
11	150	85	8,5	1	30178	2,39							
12	150	85	8,5	1	18507	2,57							

D mm	L mm	I mm	d mm		Nº Art.	€	D mm	L mm	I mm	d mm		Nº Art.	€
5	150	85	4,0	1	30174	1,43	6	200	135	4,8	1	30198	1,83
6	150	85	4,8	1	30196	1,53	8	200	135	7,5	1	30211	2,13
							10	200	135	8,5	1	30412	2,88
							12	200	135	8,5	1	30224	3,52
							14	200	135	12,0	1	30228	4,47



Línea 1m
1880

BROCA PUNTA METAL DURO PARED STANDARD

Standard MASONRY Carbide Tipped Drill Bit
Foret pointe carbure MAÇONNERIE standard



ø	3	4	5	6	7	8	9	10	12	14
Pcs	10	10	10	10	10	10	10	10	10	10

Ref. 4995 - Nº Art. 71032: **150,03 €**

Display 08



BROCA PUNTA METAL DURO PARED

MASONRY Carbide Tipped Drill Bit
Foret pointe carbure MAÇONNERIE

Ref. 1880	∅	16 L150	5 L150	6 L150	6 L200	8 L200	10 L200	12 L200	14 L200		
	Pcs	5	5	10	10	10	5	5	5		
Ref. 1485	∅	3 L60	4 L75	5 L85	6 L100	7 L100	8 L120	9 L120	10 L120	12 L150	14 L150
	Pcs	10	10	10	10	10	10	5	5	5	5
Ref. 1488	∅	Ref. 1485			Ref. 1488			Ref. 1485			
	Pcs	5			5			5			

Ref. 4995 - Nº Art. 22311: 376,10 €

Display 09



BROCAS PARED, VIDRIO, MULTIPROPÓSITO

Masonry, Glass, MultiPurpose Drill Bits
Forets maçonnerie, verre, multifonction

Ref. 1880	∅	3 L60	4 L75	5 L85	6 L100	7 L100	8 L120	9 L120	10 L120	12 L150	14 L150
	Pcs	5	5	10	10	5	6	3	3	3	3
Ref. 1836	∅	3	4	4	5	5	6	6	8	8	10
	Pcs	5	3	2	3	2	3	2	3	2	5
Ref. 1876	∅	3	4	5	5	6	6	8	8	10	12
	Pcs	5	5	5	5	5	5	5	5	5	5

Ref. 4995 - Nº Art. 22410: 608,55 €



Display 51



BROCAS METAL + PARED + MADERA

Metal + Masonry + Wood Drill Bits
Forets métal + maçonnerie + bois

Ref. 1880	∅	3	4	5	6	7	8	9	10	12	14
	Pcs	10	10	10	10	10	10	5	5	5	5
Ref. 1640	∅	3	4	5	6	8	9	10	12	14	16
	Pcs	10	10	10	10	10	5	5	5	5	5
Ref. 1001	∅	1	2	3	3,5	4	4,5	5	6	8	10
	Pcs	10	10	10	10	10	10	10	5	5	3

Ref. 4995 - N° Art. 68572: 352,99 €

Display 59



BROCAS SPEED POINT + PARED + MADERA

Speed Point + Masonry + Wood Drill Bits
Forets speed point + maçonnerie + bois

Ref. 1880	∅	3	4	5	6	7	8	9	10	12	14
	Pcs	10	10	10	10	10	10	5	5	5	5
Ref. 1640	∅	3	4	5	6	8	9	10	12	14	16
	Pcs	10	10	10	10	10	5	5	5	5	5
Ref. 1002	∅	2	3	3,5	4	4,5	5	6	7	8	10
	Pcs	10	10	10	10	10	10	5	5	5	3

Ref. 4995 - N° Art. 70099: 354,32 €

Sets
1880

BROCA PUNTA METAL DURO PARED STANDARD

Standard MASONRY Carbide Tipped Drill Bit
Foret Pointe carbure MAÇONNERIE standard



Set **1485**

5 Pcs

Cont. Ø	Nº Art.	€
4-5-6-8-10 mm	30215	7,25



Set **1488**

8 Pcs

Cont. Ø	Nº Art.	€
3-4-5-6-7-8-9-10 mm	30219	10,84

Línea 33 cm
14S1

SETS BROCAS METAL, PARED PRO, PARED, MADERA

Metal, Concrete, Masonry, Wood Sets
Jeux métal, béton, maçonnerie, bois



23 cm

	Metal Metal Métal	Pared Pro Concrete Béton	Pared Masonry Maçonnerie	Madera Wood Bois
Ref	1462-1010	1486	1485	1435
Diam	2-3-4-5-6-8 mm	4-5-6-8-10 mm	4-5-6-8-10 mm	4-5-6-8-10 mm
Pcs.	5	5	5	5

Ref. 4995 - Nº Art. 72193: **181,05 €**

Línea 33 cm
14S2

SETS BROCAS HORMIGÓN, PARED PRO, PARED

Concrete, Masonry Sets
Jeux béton, maçonnerie



26 cm

	Hormigón Concrete Béton	Pared Pro Concrete Béton	Pared Masonry Maçonnerie
Ref	1494	1487	1488
Diam	5/6x110 + 8/10x160 mm	3-4-5-6-7-8-9-10 mm	3-4-5-6-7-8-9-10 mm
Pcs.	3	5	5

Ref. 4995 - Nº Art. 72194: **230,49 €**

Ref. **1460**

SET MIXTO BROCAS

Drill Bit Mix Set
Jeu forets mix



9 Pcs

Cont. Ø	Nº Art.	€
3 Pcs Metal: 5-6-8 3 Pcs Madera/Wood/Bois: 5-6-8 3 Pcs Pared/Masonry/Béton 5-6-8	55610	11,24

Ref. **1881**

BROCA UNIVERSAL

UNIVERSAL Drill Bit
Foret UNIVERSEL



Plásticos
Plastics
Plastiques

Cerámica
Ceramics
Céramique

Ladrillo
Brick
Brique

Madera
Wood
Bois

D mm	L mm	I mm		Nº Art.	€
4	103	50	1	19065	5,85
5	112	50	1	19066	5,40
6	123	60	1	19069	5,64
8	134	80	1	19072	6,58
10	135	80	1	19075	8,11
12	153	90	1	19076	10,26



Línea 33 cm
1881

BROCA UNIVERSAL

UNIVERSAL Drill Bit
Foret UNIVERSEL

∅	4	5	6	8	10	12
Pcs	5	6	5	5	5	5

Ref. 4995 - Nº Art. 71034: 209,22 €

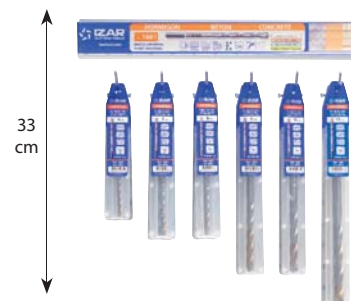

Display
09

BROCAS PARED, VIDRIO, MULTIPROPÓSITO

Masonry, Glass, MultiPurpose Drill Bits
Forets maçonnerie, verre, multifonction

Ref. 1880	∅	3 L60	4 L75	5 L85	6 L100	7 L100	8 L120	9 L120	10 L120	12 L150	14 L150
	Pcs	5	5	10	10	5	6	3	3	3	3
Ref. 1836	∅	3	4	4	5	5	6	6	8	8	10
	Pcs	5	3	2	3	2	3	2	3	2	5
Ref. 1876	∅	3	4	5	5	6	6	8	8	10	12
	Pcs	5	5	5	5	5	5	5	5	5	5

Ref. 4995 - Nº Art. 22410: 608,55 €



Ref. **1889**

BROCA UNIVERSAL

UNIVERSAL Drill Bit
Foret UNIVERSEL



D mm	L mm	I mm		Nº Art.	€ 1 ud.
5	112	50	10	21925	4,87
6	123	60	10	21926	5,06
8	134	80	10	21927	5,91

Una broca para TODOS los materiales
One Drill Bit for ALL Materials
Un foret pour TOUS les matériaux

Ref. **1876**

BROCA PUNTA METAL DURO MULTIPROPÓSITO

MultiPurpose Carbide Tipped Drill Bit
Foret pointe carbure Multifonction

New!



MULTIMAT



Video

Hormigón
Concrete
Béton

Ladrillo
Brick
Brique

Cerámica
Ceramics
Céramique

Porcelánico Blando
Soft Porcelain
Porcelaine tendre

Aceros
Steels
Aciers

Madera
Wood
Bois

Plásticos
Plastics
Plastiques

D mm	L mm	I mm		Nº Art.	€
3	70	35	1	25533	4,33
4	75	40	1	25534	4,15
5	85	50	1	25536	4,52
6	100	65	1	25539	5,38
8	120	70	1	25542	7,00
10	120	70	1	25546	8,67
12	150	90	1	25549	11,21

D mm	L mm	I mm		Nº Art.	€
6	150	90	1	25540	5,95
8	150	90	1	25543	7,54
10	150	90	1	25548	9,23



Display
72



27,5
cm

∅	3	4	5	5	6	6	8	8	10	12
Pcs	5	5	5	5	5	5	5	5	5	5

Ref. 4995 - Nº Art. 40228: **310,80 €**

- Punta de metal duro con afilado exclusivo IZAR
- Apta para trabajar con percusión (hormigón) y rotación (ladrillo, cerámica, chapa, madera y plásticos)
- Canales amplios, mejor desahogo del polvo / viruta
- Permite trabajo en seco, optimizado con refrigeración
- Perforación con precisión
- Geometría innovadora que permite una rápida perforación
- Tratamiento superficial IZAR BLUE, evita la adherencia del polvo / viruta
- Carbide Tip with exclusive Sharpening
- Suitable for working with Percussion (Concrete) & Rotation (Brick, Ceramics, Sheets, Wood & Plastic)
- Wide Flutes, better dust / chip relief
- Dry Running allowed, optimized with Cooling
- Drilling with Precision
- Innovative Geometry that allows Fast Drilling
- IZAR BLUE Surface Treatment, prevents the adhesion of dust / chips
- Pointe carbure avec affûtage exclusif
- Convient pour travailler avec percussion (béton) et rotation (brique, céramique, tôle, bois et plastique)
- Goujure large, meilleur soulagement des poussières / copeaux
- Travail à sec, optimisé avec réfrigération
- Perçage avec précision
- Géométrie innovante qui permet un perçage rapide
- Traitement de surface IZAR BLUE, empêche l'adhérence des poussières / copeaux

Ref. **1836**

BROCA VIDRIO

GLASS Drill Bit
Foret VERRE

¡NUEVO MODELO MEJORADO!
New improved model!
Nouveau modèle amélioré !



Vidrio
Glass
Verre

Cerámica
Ceramics
Céramique

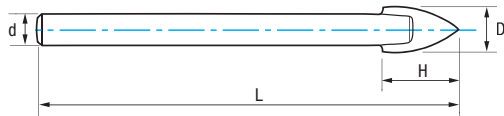

D mm	d mm	L mm	H mm		Nº Art.	€
3	2,80	70	6	1	30239	5,67
4	3,20	75	8	1	30240	6,23
5	4,00	80	10	1	30241	6,61
6	4,80	85	12	1	30242	7,01
8	6,30	90	16	1	30243	8,58
10	7,50	100	20	1	30244	12,02



Línea 33 cm
1836

BROCA VIDRIO

GLASS Drill Bit
Foret VERRE



ø	3	4	5	6	8	10
Pcs	5	5	5	5	5	5

Ref. 4995 - Nº Art. 71037: 230,65 €

Ref. **1699**

PUNTERO MARCADOR

Pencil Scriber
Traçeur carbure



Aceros
Steel
Aciers

Madera
Wood
Bois

Cerámica
Ceramics
Céramique

	Nº Art.	€
1	18856	4,98

Ref. **1601**

BROCA PUNTA METAL DURO MULTIPROPÓSITO E6.3

E6.3 MultiPurpose Carbide Tipped Drill Bit
Foret pointe carbure Multifonction E6.3



MD/HM
TCT



1/4"
DIN E6.3

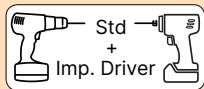

D mm	L mm	I mm	d mm		Nº Art.	€
4,00	90	45	6,35	1	55997	2,50
5,00	100	50	6,35	1	55998	2,65
6,00	100	50	6,35	1	55999	2,85
8,00	120	60	6,35	1	56000	3,79
10,00	120	60	6,35	1	56001	4,78



4 Pcs

Cont. Ø	Nº Art.	€
4-5-6-8 mm	59081	11,79

Línea 33 cm
1601

BROCA PUNTA METAL DURO MULTIPROPÓSITO E6.3

E6.3 MultiPurpose Carbide Tipped Drill Bit
Foret pointe carbure Multifonction E6.3



Ø	4	5	6	8	10
Pcs	5	5	5	5	5

Ref. 4995 - Nº Art. 72200: **82,96 €**

Display
54

BROCAS METAL + PARED + MADERA

Metal + Masonry + Wood Drill Bits
Forets Métal + Maçonnerie + Bois



Ref. 1611								
Ø	2	3	3,25	3,5	4	5	6	8
Pcs	3	3	3	3	3	3	3	3
Ref. 1610						Ref. 1601		
Ø	M3	M4	M5	M6	M8	M10	4	5
Pcs	2	2	2	2	2	2	3	3
Ref. 1601				Ref. 1621				
Ø	6	8	10	3	4	5	6	8
Pcs	3	3	3	3	3	3	3	3

Ref. 4995 - Nº Art. 69804: **430,06 €**

Ref. **1461**

SET BROCAS MANGO HEXAGONAL 1/4" Y PUNTAS DE ATORNILLAR

Hexagonal Shank Drill Bit and Screwdriver Bit Set
Jeu de forets hexagonales et embouts vissage



42
pcs



Brocas rectificadas Metal Mango HEX
HEX Shank Metal Ground Drill Bits
Forets rectifiés métal queue HEX
2 - 2,5 - 3 - 3,5 - 4 - 5 - 6 mm

Brocas Pared
Masonry Drill Bits
Forets maçonnerie
4 - 5 - 6 - 8 mm

Brocas Madera
Wood Drill Bits
Forets bois
3 - 4 - 5 - 6 - 8 mm

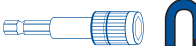
Adapt. Quick-Lock
INOX/Stainless

L mm: 60 - d mm: 6,35
1 pc.

Cuter Hoja Partible
Snap-Off Box Cutter
Couteaux à lames rétractables
1 pc.

Puntas Atornillar / Screwdriver Bits / Embouts vissage

PH d mm: 6,35
PH1
PH2
PH3
|←25 mm→|

d mm: 6,35
Tx
T10
T15
T20
T25
T27
T30
T40
|←25 mm→|

d mm: 6,35
SL
SL 4
SL 5,5
SL 6,5
|←25 mm→|

PZ d mm: 6,35
PZ1
PZ2
PZ3
|←25 mm→|

HEX d mm: 6,35
H3
H4
H5
|←25 mm→|

d mm: 6,35
Ts
TS15
TS20
TS25
TS30
TS40
|←25 mm→|

Nº Art.	€
79873	70,51

CORONAS

Hole Saws

Trépan

Ref. **1645**

SIERRA CORONA METAL / MADERA

METAL / WOOD Hole Saw

Trépan MÉTAL / BOIS



HSSE 8% Co		INOX Stain- less	Bimetal	Aceros <850 N/mm ² Steel / Aciers	INOX Stainless Steel Acier INOX
TPI 4-6				Fundición Cast Iron Fonte	Cobre Copper Cuivre
				Madera Wood Bois	



D mm	L mm	P.G.	Pulgadas Inches / Pouces		Nº Art.	€	D mm	L mm	P.G.	Pulgadas Inches / Pouces		Nº Art.	€
14	37		9/16	1	20094	10,97	57	37		2 1/4	1	30325	18,83
16	37	9	5/8	1	20104	10,97	59	37	48	2 5/16	1	30326	18,83
17	37		11/16	1	21321	10,97	60	37		2 3/8	1	30328	18,83
19	37	11	3/4	1	30250	10,97	63	37		2 31/64	1	18801	20,53
20	37		25/32	1	30258	10,97	64	37		2 1/2	1	30329	20,53
21	37	14	13/16	1	30260	10,97	65	37		2 9/16	1	30331	20,53
22	37	16	7/8	1	30265	10,97	67	37		2 5/8	1	30388	20,53
23	37		14/16	1	30268	10,97	68	37		2 11/16	1	30391	20,53
24	37		15/16	1	30274	10,97	70	37		2 3/4	1	30392	20,53
25	37		1	1	30282	11,51	73	37		2 7/8	1	30393	20,53
27	37		1 1/16	1	30287	12,17	76	37		3	1	30394	21,03
29	37	21	1 1/8	1	30289	12,17	79	37		3 1/8	1	30395	21,04
30	37		1 3/16	1	30293	12,17	83	37		3 1/4	1	30396	21,04
32	37		1 1/4	1	30297	12,17	86	37		3 3/8	1	30397	21,04
33	37		1 5/16	1	30301	12,17	89	37		3 1/2	1	30398	21,04
35	37		1 3/8	1	30302	12,95	92	37		3 5/8	1	30399	24,41
37	37	29	1 7/16	1	30304	12,95	95	37		3 3/4	1	30400	28,63
38	37		1 1/2	1	30307	12,95	98	37		3 7/8	1	30401	30,66
40	37		1 9/16	1	30308	12,97	102	37		4	1	30402	32,03
41	37		1 5/8	1	30310	12,97	105	37		4 1/8	1	52485	35,65
43	37		1 11/16	1	30313	12,97	114	37		4 1/2	1	30403	59,87
44	37		1 3/4	1	30315	15,97	121	37		4 3/4	1	30404	66,72
46	37		1 13/16	1	30316	15,97	127	37		5	1	30405	70,85
48	37	36	1 7/8	1	30318	15,97	140	37		5 1/2	1	30406	75,76
50	37		1 31/32	1	18800	15,97	152	37		6	1	30407	78,55
51	37		2	1	30320	15,97	160	37		6 5/16	1	24475	154,47
52	37		2 1/16	1	30321	18,79	210	37		8 9/32	1	24606	182,75
54	37	42	2 1/8	1	30323	18,79							

Husillos y Adaptadores: Pag. 255 / Spindles & Adaptors: Pag. 255 / Arbres et Adaptateurs: Pag. 255



Línea 1m 1645

SIERRA CORONA METAL / MADERA

METAL / WOOD Hole Saw

Trépan MÉTAL / BOIS



ø	16	19	20	22	24	25	27	29	30	32	35	51	64	65	H3A	H4A
Pcs	2	2	2	2	2	2	2	2	2	2	2	2	2	2	2	2

Ref. 4995 - N° Art. 71040: 436,82 €

Display 19

SIERRA CORONA METAL / MADERA

METAL / WOOD Hole Saw

Trépan MÉTAL / BOIS



ø	16	19	20	22	24	25	27	29	30	32	35
Pcs	2	2	2	2	2	2	2	2	2	2	2
Ref. 1645	ø	38	40	41	43	44	48	51	54		
	Pcs	2	2	2	2	2	2	2	2	2	
Ref. 1645 1646	ø	60	65	68	70	76	79				
	Pcs	2	2	2	2	2	2	2			
Ref. 1645 1646	ø	83	89	102	H3A	H4A	BR 90	BR 110			
	Pcs	1	1	1	3	3	3	3			

Ref. 4995 - N° Art. 22220: 934,49 €

Sets 1645

SIERRA CORONA METAL / MADERA

METAL / WOOD Hole Saw
Trépan MÉTAL / BOIS

Mod. 1
7 Pcs

Básico
Basic
Essentiel



Cont. Ø mm	Nº Art.	€
25-35-43-51-64-H3A-H4A	18232	107,30

Mod. 2
14 Pcs

Completo
Complete
Complet



Cont. Ø mm	Nº Art.	€
19-22-25-32-35-38-43-51-57-60-64-76-H3A-H4A	18234	213,07

Mod. 3
12 Pcs

Electricista
Electrician
Electricien



Cont. Ø mm	Nº Art.	€
16-20-25-32-40-43-51-60-63-65-H3A-H4A	18235	180,80

Mod. 4
8 Pcs

Básico 2
Basic 2
Essentiel 2



Cont. Ø mm	Nº Art.	€
16-20-25-32-40-51-H3A-H4A	58617	107,92

Mod. 5
11 Pcs

Electricista 2
Electrician 2
Electricien 2



Cont. Ø mm	Nº Art.	€
16-20-27-32-40-43-48-51-64-H3A-H4A	58618	158,07

Mod. 6
8 Pcs

Electricista 3
Electrician 3
Electricien 3



Cont. Ø mm	Nº Art.	€
22-35-51-57-68-76-H3A-H4A	66889	133,64

Ref. **1647**

CORONA MULTIPRO

MULTIPRO Hole Saw
Trépan MULTIPRO

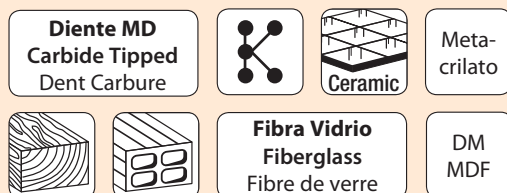

D mm	L mm	Pulgadas Inches / Pouces	Z		Nº Art.	€	D mm	L mm	Pulgadas Inches / Pouces	Z		Nº Art.	€
16	57	5/8	1	1	31855	10,88	65	57	2 3/16	3	1	30710	20,38
19	57	3/4	1	1	30691	10,88	67	57	2 5/8	3	1	30711	20,38
20	57	25/32	1	1	30692	10,88	68	57	2 11/16	3	1	30712	20,38
22	57	7/8	1	1	30693	10,88	70	57	2 3/4	3	1	30713	20,38
24	57	15/16	1	1	31856	11,43	73	57	2 7/8	3	1	30714	20,38
25	57	1	1	1	30694	11,43	76	57	3	4	1	30715	20,85
27	57	1 1/16	1	1	30695	12,08	79	57	3 1/8	4	1	30716	20,86
29	57	1 1/8	1	1	30696	12,08	83	57	3 1/4	4	1	30717	20,86
30	57	1 3/16	1	1	30697	12,08	86	57	3 3/8	4	1	30718	20,86
32	57	1 1/4	1	1	30698	12,08	89	57	3 1/2	4	1	30719	20,86
35	57	1 3/8	1	1	30699	12,88	92	57	3 5/8	4	1	30720	24,21
38	57	1 1/2	1	1	30700	12,88	95	57	3 3/4	4	1	30721	28,39
40	57	1 9/16	2	1	30701	12,88	98	57	3 7/8	4	1	30722	30,40
41	57	1 5/8	2	1	30702	12,88	102	57	4	5	1	30723	31,77
43	57	1 11/16	2	1	31857	15,84	105	57	4 1/8	5	1	30724	33,98
44	57	1 3/4	2	1	30703	15,84	108	57	4 1/4	5	1	30725	36,35
48	57	1 7/8	2	1	30704	15,84	111	57	4 3/8	5	1	30726	38,91
51	57	2	2	1	30705	15,84	114	57	4 1/2	5	1	30727	59,34
54	57	2 1/8	2	1	30706	18,62	121	57	4 3/4	5	1	30728	66,15
57	57	2 1/4	2	1	30707	18,67	127	57	5	5	1	30729	70,25
60	57	2 3/8	3	1	30708	18,67	140	57	5 1/2	5	1	30730	75,11
64	57	2 1/2	3	1	30709	19,40	152	57	6	5	1	30731	77,88
							160	57	6 5/16	5	1	30732	102,12

Husillos y Adaptadores: Pag. 255 / Spindles & Adaptors: Pag. 255 / Arbres et Adaptateurs: Pag. 255

- **Recomendado para terrazas de madera y tarimas sintéticas. Por ejemplo, en colocación de luces de suelo.**
- **Highly recommended for open terrace flooring, both wood and synthetic, e.g. on ground light installations.**
- **Recommandé pour les terrasses en bois et les terrasses synthétiques. Par exemple, lors de l'installation de lumières au sol.**

Línea 1m 1647

CORONA MULTIPRO

MULTIPRO Hole Saw
Trépan MULTIPRO

30
cm



∅	25	29	30	35	40	51	60	67	68	73	76	H3C	H4C	BRC 110
Pcs	2	2	2	2	1	1	1	1	1	1	1	3	3	3

Ref. 4995 - N° Art. 72151: 337,86 €

Display 60

CORONA MULTIPRO

MULTIPRO Hole Saw
Trépan MULTIPRO



∅	16	19	20	22	24	25	27	29	30	32	35
Pcs	2	2	2	2	2	2	2	2	2	2	2
Ref. 1647	∅	38	40	41	43	44	48	51	54		
	Pcs	2	2	2	1	1	1	1	1		
Ref. 1647 1646	∅	60	65	68	70	76	79				
	Pcs	1	1	1	1	1	1				
Ref. 1647 1646	∅	83	89	102	H3C	H4C	BRC 110	BRC 110			
	Pcs	1	1	1	3	3	3	3			

Ref. 4995 - N° Art. 32965: 732,47 €



Ref. **1661**

SIERRA CORONA DIENTE MD INTEGRAL

Carbide Teeth Core Drill
Trépan denture carbure



Diente MD
Carbide Tipped
Dent Carbure



Fundición
Cast Iron
Fonte

INOX
Stain-
less

Fibra Vidrio
Fiberglass
Fibre de verre

INOX
Stainless Steel
Acier INOX

Fundición
Cast Iron
Fonte

Plásticos
Plastics
Plastiques

Madera
Wood
Bois

Cerámica
Ceramics
Céramique



D mm	L mm	Pulgadas Inches / Pouces		Nº Art.	€
19	31	3/4	1	34311	21,84
22	31	7/8	1	34312	23,36
25	31	1	1	34313	24,43
29	31	1 1/8	1	34314	27,42
32	31	1 1/4	1	34315	28,80
35	31	1 3/8	1	34316	32,11
38	31	1 1/2	1	34317	34,04
44	31	1 3/4	1	34318	35,98
48	31	1 7/8	1	34319	39,33
51	31	2	1	34320	41,48
54	31	2 1/8	1	34321	42,51
57	31	2 1/4	1	34322	43,58
60	31	2 3/8	1	34323	45,69
64	31	2 1/2	1	34324	47,78
67	31	2 5/8	1	36831	50,18
70	31	2 3/4	1	34325	53,16
76	31	3	1	34326	53,61
83	31	3 1/4	1	34327	57,39
86	31	3 3/8	1	34328	60,30
89	31	3 1/2	1	34329	63,22
95	31	3 3/4	1	34330	73,33
102	31	4	1	34331	77,60

Husillos y Adaptadores: Pag. 255 / Spindles & Adaptors: Pag. 255 / Arbres et Adaptateurs: Pag. 255

Ref. **1662**

CORONA POLVO MD ELECTRODEPOSITADO

Electrodeposited Carbide Powder Core Drill Bit
Trépan Poudre carbure électrodéposé



Polvo MD
Carbide Powder
Poudre Carbure

Ceramic

Kevlar



Fibra Vidrio
Fiberglass
Fibre de verre

Vidrio
Glass
Verre

Ladrillo
Brick
Brique

Cerámica
Ceramics
Céramique



D mm	L mm	Pulgadas Inches / Pouces		Nº Art.	€
16	36	5/8	1	34289	14,18
19	36	3/4	1	34290	15,50
20	36	25/32	1	34291	16,40
22	36	7/8	1	34292	17,16
25	36	1	1	34293	16,35
29	36	1 1/8	1	34294	17,73
32	36	1 1/4	1	34295	17,88
35	36	1 3/8	1	34296	18,45
38	36	1 1/2	1	34297	20,06
44	36	1 3/4	1	34298	20,12
48	36	1 7/8	1	34299	21,63
51	36	2	1	34300	22,07
54	36	2 1/8	1	34301	21,50
57	36	2 1/4	1	34302	23,55
60	36	2 3/8	1	34303	24,24
64	36	2 1/2	1	34304	24,78
70	36	2 3/4	1	34305	28,39
76	36	3	1	34306	31,42
83	36	3 1/4	1	34307	32,01
86	36	3 3/8	1	34308	34,61
95	36	3 3/4	1	34309	36,65
102	36	4	1	34310	40,10

Husillos y Adaptadores: Pag. 255 / Spindles & Adaptors: Pag. 255 / Arbres et Adaptateurs: Pag. 255



Ref. **1646**

HUSILLOS Y BROCCAS CORONAS

Hole Saw Spindles & Drill Bits
Arbres et forets trépan



HSS

Mod.	d mm	Corona Hole Saw Trépan mm		Nº Art.	€
H3A	9,52	14-30	1	19602	12,24
H4A	9,52	32-210	1	19603	21,09

MD/HM TCT

Mod.	d mm	Corona Hole Saw Trépan mm		Nº Art.	€
H3C	9,52	14-30	1	39848	12,24
H4C	9,52	32-210	1	39849	21,09

MD/HM TCT

Mod.	d mm	Corona Hole Saw Trépan mm		Nº Art.	€
New! H3S	SDS plus	14-30	1	13724	16,32
New! H4S	SDS plus	32-210	1	13725	32,46

Mod.	D mm	L mm		Nº Art.	€
BR 90	6,35	90	1	19605	3,52
BR 110	6,35	110	1	30019	3,85
BRC 110	7,00	110	1	39850	3,85



Ref. **1642**

ALARGADOR

Extension
Rallonge



Cap. mm	d mm	L mm		Nº Art.	€
9,52	11,00	300	1	69878	20,00



ELECCIÓN HUSILLOS Y BROCAS CORONAS

Hole Saw Spindles & Drill Bits Choice

Choix des arbres et forets trépan



INOX
Stain-
less



H3A



H4A



* BR 90 / BR 110

H3C



H4C



H3S



H4S



* BRC 110

* BR 110



Ref. 1647



Ref. 1645



Ref. 1661



Ref. 1662



Ref. **1860**

CORONA DIAMANTE HORMIGÓN

CONCRETE Diamond Core Bit

Trépan diamant BÉTON



Hormigón Reforzado
Reinforced Concrete
Béton armé

Hormigón
Concrete
Béton

Hormigón Bloque
Concrete Block
Parpaing



D mm	Rosca Thread Filet	L mm	Nº Segmentos	Alto Height Haut Segmento mm	Largo Length Longueur Segmento mm	Ancho Width Largeur Segmento mm	Kw*		Nº Art.	€
32	1" 1/4	450	3	9	24	4	0,7>1,2	1	34333	123,60
42	1" 1/4	450	4	9	24	4	0,7>1,2	1	34334	134,84
52	1" 1/4	450	5	9	24	4	0,7>1,2	1	34335	146,09
62	1" 1/4	450	6	9	24	4	0,7>1,2	1	34336	168,57
72	1" 1/4	450	6	9	24	4	0,7>1,2	1	34337	202,30
82	1" 1/4	450	7	9	24	4	1,2>2,3	1	34338	213,55
92	1" 1/4	450	8	9	24	4	1,2>2,3	1	34339	247,25
102	1" 1/4	450	9	9	24	4	1,2>2,3	1	34340	269,75
112	1" 1/4	450	9	9	24	4	1,2>2,3	1	34341	280,98
122	1" 1/4	450	10	9	24	4	1,2>2,3	1	34342	303,47
127	1" 1/4	450	11	9	24	4	1,2>2,3	1	34332	320,27
132	1" 1/4	450	11	9	24	5	1,2>2,3	1	34343	337,20
142	1" 1/4	450	12	9	24	5	1,2>2,3	1	34344	393,40
152	1" 1/4	450	12	9	24	5	1,2>2,3	1	34357	393,40
162	1" 1/4	450	12	9	24	5	2,3>3,9	1	34345	415,89
172	1" 1/4	450	13	9	24	5	2,3>3,9	1	34346	472,09
182	1" 1/4	450	13	9	24	5	2,3>3,9	1	34347	483,33
200	1" 1/4	450	15	9	24	5	2,3>3,9	1	34349	539,55
225	1" 1/4	450	15	9	24	5	2,3>3,9	1	34350	640,72
250	1" 1/4	450	16	9	24	5	2,3>3,9	1	34351	708,16
300	1" 1/4	450	17	9	24	5	2,3>3,9	1	34352	899,27

*Aplicar esta potencia y usar mucha agua para un rendimiento óptimo de la corona

*Use this power and plenty of water for an optimum performance of the core bit

*Appliquez cette puissance et utilisez de l'eau pour rendement optimale des trépan



DISCOS DIAMANTE

Diamond Cutting Blades

Disques diamant

CUADRO USO DISCOS DIAMANTE

Diamond Disc Use Table

Tableau utilisation disques diamant

		Ref. 1851	Ref. 1852	Ref. 1853	Ref. 1854	Ref. 1855	Ref. 1857	Ref. 1858	Ref. 1861	Ref. 1862	Ref. 1863	Ref. 1864
<ul style="list-style-type: none"> ● Ideal - Ideal - Idéal ◐ Adecuado - Suitable - Convenable ○ Posible - Possible 												
	Hormigón Reforzado Reinforced Concrete Béton armé				●							
	Hormigón Seco Dry Concrete Béton sec	○	◐		●			◐				
	Hormigón Duro Hard Concrete Béton dur		○		●			◐				
	Hormigón Blando Soft Concrete Béton tendre	○	◐			◐						
	Hormigón Universal Universal Concrete Béton universel	◐	●		●		●	●	◐			
	Hormigón Silex Flint Concrete Béton silex						◐		○			
	Ladrillo Brick Brique	○	◐									
	Granito Duro Hard Granite Granite dur			◐	◐					●	◐	●
	Granito Medio Medium Granite Granite moyen		○					○			●	
	Granito Blando Soft Granite Granite tendre	○	◐					◐				
	Mármol Marble Marbre									●		
	Piedra Natural / Dura Natural / Hard Stone Pierre naturelle / Dure				○					○	○	
	Asfalto, Abrasivos Asphalt, Abrasives Asphalte, Abrasifs					●						
	Porcelánico, Gres, Azulejo Duro Porcelain, Stoneware, Hard Tile Porcelaine, Céramique, Carreau dur			●								

Ref. **1851**

SEGMENTADO RÁPIDO OBRA GENERAL

General Works **Fast** Segmented
Segmenté **rapide** général travaux



Hormigón Universal
Universal Concrete
Béton universel

Hormigón Seco
Dry Concrete
Béton sec

Hormigón Blando
Soft Concrete
Béton tendre

Granito Blando
Soft Granite
Granite tendre

Ladrillo
Brick
Brique



D mm	d1 mm	Nº Segmentos	Alto Height Haut Segmento mm	Ancho Width Largeur Segmento mm	Grosor Acero Steel Thickness Épaisseur acier mm	Max R.P.M.		Nº Art.	€
115	22,23	8	12	2,40	1,4	13300	1	60720	7,90
125	22,23	9	12	2,40	1,4	12250	1	60722	9,39
180	22,23	14	12	2,60	1,6	8500	1	67886	18,98
230	22,23	16	12	2,80	1,8	6650	1	60723	23,95
300	25,40	22	12	3,20	2,2	6400	1	60724	46,63
350	25,40	24	12	3,20	2,2	5500	1	60725	57,73

Ref. **1852**

SEGMENTADO LÁSER PROFESIONAL ALTO RENDIMIENTO

Long Life Professional Segmented Laser
Professionnel segmenté laser **haut rendement**



Hormigón Universal
Universal Concrete
Béton universel

Hormigón Seco
Dry Concrete
Béton sec

Hormigón Duro
Hard Concrete
Béton dur

Granito Medio
Medium Granite
Granite moyen

Granito Blando
Soft Granite
Granite tendre

Ladrillo
Brick
Brique



D mm	d1 mm	Nº Segmentos	Alto Height Haut Segmento mm	Ancho Width Largeur Segmento mm	Grosor Acero Steel Thickness Épaisseur acier mm	Max R.P.M.		Nº Art.	€
115	22,23	9	10	2,20	1,4	13300	1	64078	22,95
125	22,23	10	10	2,20	1,4	12250	1	60729	30,04
150	22,23	12	10	2,20	1,4	10200	1	60730	36,25
180	22,23	14	10	2,40	1,6	8500	1	68880	41,37
230	22,23	16	10	2,60	1,8	6650	1	60731	52,39
300	20,00	20	10	3,00	2,2	6400	1	68883	70,66
350	20,00	20	10	3,20	2,4	5500	1	68889	84,54
350	25,40	23	10	3,20	2,4	5500	1	68890	84,54

Ref. **1858**

TURBO OBRA GENERAL

General Works Turbo
Général travaux turbo



Hormigón Universal Universal Concrete Béton universel	Hormigón Seco Dry Concrete Béton sec	Hormigón Duro Hard Concrete Béton dur
--	---	--

Granito Medio Medium Granite Granite moyen	Granito Blando Soft Granite Granite tendre
---	---

D mm	d1 mm	Nº Segmentos	Alto Height Haut Segmento mm	Ancho Width Largeur Segmento mm	Grosor Acero Steel Thickness Épaisseur acier mm	Max R.P.M.		Nº Art.	€
115	22,23	9	10	2,20	1,4	13300	1	64080	20,54
125	22,23	10	10	2,20	1,4	12250	1	60726	25,97
150	22,23	12	10	2,20	1,4	10200	1	60727	30,84
180	22,23	14	10	2,40	1,6	8500	1	69565	41,37
230	22,23	16	10	2,60	1,8	6650	1	60728	63,80

Ref. **1854**

SOLDADO LASER FORMA N

N Form Laser Welded
Soudé laser forme N



Hormigón Reforzado Reinforced Concrete Béton armé	Hormigón Seco Dry Concrete Béton sec	Hormigón Duro Hard Concrete Béton dur
--	---	--

Hormigón Universal Universal Concrete Béton universel	Granito Duro Hard Granite Granite dur	Piedra Natural Natural Stone Pierre naturelle
--	--	--

D mm	d1 mm	Nº Segmentos	Alto Height Haut Segmento mm	Ancho Width Largeur Segmento mm	Grosor Acero Steel Thickness Épaisseur acier mm	Max R.P.M.		Nº Art.	€
125	22,23	10	10	2,20	1,4	12250	1	60740	33,37
180	22,23	14	10	2,40	1,6	8500	1	68895	53,21
230	22,23	15	10	2,60	1,8	6650	1	60741	59,01
300	25,40	20	10	3,00	2,2	6400	1	60742	111,94
350	25,40	23	10	3,00	2,2	5500	1	60743	139,22

Ref. **1853**

TURBO PORCELÁNICO

PORCELAIN Turbo
Turbo PORCELAINE



Porcelánico, Gres, Azulejo Duro
Porcelain, Stoneware, Hard Tile
Porcelaine, Céramique, Carreau dur

Granito Duro
Hard Granite
Granite dur

D mm	d1 mm	Nº Segmentos	Alto Height Haut Segmento mm	Ancho Width Largeur Segmento mm	Grosor Acero Steel Thickness Épaisseur acier mm	Max R.P.M.		Nº Art.	€
115	22,23	Continuo	11	1,30	1,0	13300	1	60732	27,46
125	22,23	Continuo	11	1,30	1,0	12250	1	60739	30,19
230	22,23	Continuo	11	1,50	1,2	6650	1	66552	65,38

Ref. **1855**

SOLDADO LASER ASFALTO

ASPHALT Laser Welded
Soudé Laser ASPHALTE



Asfalto, Abrasivos
Asphalt, Abrasives
Asphalte, Abrasifs

Hormigón Blando
Soft Concrete
Béton tendre

Gran protección del segmento para evitar el corte inferior
No undercutting by strong wedge protection
Forte protection du ségment pour éviter la coupe inférieure.

D mm	d1 mm	Nº Segmentos	Alto Height Haut Segmento mm	Ancho Width Largeur Segmento mm	Grosor Acero Steel Thickness Épaisseur acier mm	Max R.P.M.		Nº Art.	€
300	25,40	18	10	3,20	2,2	6400	1	60744	80,10
350	25,40	21	10	3,20	2,2	5500	1	60745	102,85
400	25,40	24	10	3,40	2,4	4800	1	60747	130,75

Ref. **1861**

HORMIGÓN FORMA DOBLE COPA

Double Rowed Cup Form Concrete
Béton forme double coupe



Hormigón Universal
Universal Concrete
Béton universel

Hormigón Silex
Flint Concrete
Béton Silex



D mm	d1 mm	Nº Segmentos	Alto Height Haut Segmento mm	Ancho Width Largeur Segmento mm	Grosor Acero Steel Thickness Épaisseur acier mm	Max R.P.M.		Nº Art.	€
115	22,23	12	8	5,00	3,0	13300	1	69473	49,18
125	22,23	14	8	5,00	3,0	12250	1	69475	53,67
180	22,23	28	8	5,00	3,0	8500	1	69477	102,86

Ref. **1857**

TOP HORMIGÓN FORMA COPA Y ALTO RENDIMIENTO

Long Life Y Cup Form Concrete
Top béton forme coupe Y haut rendement



Hormigón Universal
Universal Concrete
Béton universel

Hormigón Silex
Flint Concrete
Béton Silex



Segmentos auto-afilados, superficie fina, tolerancia precisa, eficiente extracción del polvo
Self-sharpened segments, smooth surface, accurate tolerance, efficient dust exhausting
Ségments auto-affûtés, Surface fine, tolerance précise, extraction efficace de la poussière

D mm	d1 mm	Nº Segmentos	Grosor Acero Steel Thickness Épaisseur acier mm	Max R.P.M.		Nº Art.	€
115	22,23	8	3,0	13300	1	60749	59,61
125	22,23	8	3,0	12250	1	60750	67,60
180	22,23	12	3,0	8500	1	64082	132,74

Ref. **1864**

GRANITO FORMA COPA "Y" DE ALUMINIO

Aluminium Cup Wheel for **Granite**
Granite forme coupe "Y" aluminium

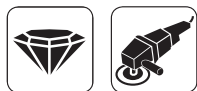

Granito Duro
Hard Granite
Granite Dur

Cuerpo de aluminio, filo amolado fino
Aluminium body, smooth edge grinding
Corps en aluminium, filet meulé fin



D mm	d1 mm	Alto Height Haut Segmento mm	Ancho Width Largeur Segmento mm	Grosor Acero Steel Thickness Épaisseur acier mm	Max R.P.M.		Nº Art.	€
100	22,23	20	7,30	5,5	14500	1	69487	71,55

Ref. **1862**

TURBO GRANITO / MÁRMOL

Turbo Granite / **Marble**
Turbo granite / **marbre**

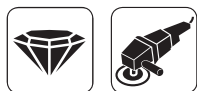

Granito Duro
Hard Granite
Granite dur

Mármol
Marble
Marbre

Piedra Dura
Hard Stone
Pierre dure

Forma en ola, no descascarilla el material
Wave shape, no wobbling during cutting
Forme vaguée, matériel sans décortilage



D mm	d1 mm	Alto Height Haut Segmento mm	Ancho Width Largeur Segmento mm	Grosor Acero Steel Thickness Épaisseur acier mm	Max R.P.M.		Nº Art.	€
115	22,23	7	2,20	1,2	13300	1	69479	28,17
230	22,23	8	2,60	1,8	6650	1	69481	71,55

Ref. **1863**

LASER CANTERO

Laser Quarry
Laser carrière

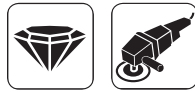

Granito Duro
Hard Granite
Granite dur

Granito Medio
Medium Granite
Granite moyen

Piedra Dura
Hard Stone
Pierre dure



Corte estable y gran rendimiento
Stable cutting high performance
Coupe stable et haute performance

D mm	d1 mm	Nº Segmentos	Alto Height Haut Segmento mm	Ancho Width Largeur Segmento mm	Grosor Acero Steel Thickness Épaisseur acier mm	Max R.P.M.		Nº Art.	€
230	22,23	15	12	3,20	2,2	6650	1	69485	89,44

Ref. **1849**

AMARRE RÁPIDO AMOLADORA

Quick Lock Grinding Tool
Attachement rapide meuleuse



Mod.	Nº Art.	€
1	55946	23,87



New!

6 Pcs

Nº Art.	€
24140	136,06

Ref. **8309**

CUTER HOJA PARTIBLE 9 MM

9 mm Snap-Off Blade Box Cutter
Couteau à lames rétractables 9 mm

MOD. 9



Zamak
5



Mod.	Hoja Blade / Lame mm		Nº Art.	€
9	9	1	34238	10,32

Cúter con cuerpo metálico con mecanismo de bloqueo y almacén para cuchillas de repuesto. Incluye 3 cuchillas.

Box Cutter with metal body, locking mechanism and storage for spare blades. Includes 3 blades.

Couteau à lames avec corps en métal, mécanisme de verrouillage et dépôt pour les lames de rechange. Comprend 3 lames.

Ref. **8318**

CUTER HOJA PARTIBLE 18 MM

18 mm Snap-Off Blade Box Cutter
Couteau à lames rétractables 18 mm

New! **MOD. 18-ERG**



Mod.	Hoja Blade / Lame mm		Nº Art.	€
18-ERG	18	1	83359	4,10

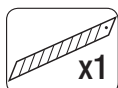

- Cuchilla de 15 Segmentos
- 15 segment blade
- Lame à 15 segments

ABS
Soft

- Ergonómico. ABS para mejor agarre
- Ergonomic. ABS for better grip
- Ergonomique. ABS pour une meilleure prise

INOX
Stainless

- Portacuchillas inoxidable
- Stainless blade holder
- Porte-lames inoxydable



Box-Pallet
8320

24 uds

Nº
Art. €
10177 93,53

MOD. 18



Zamak
5

Mod.	Hoja Blade / Lame mm		Nº Art.	€
18	18	1	34239	16,97

Cúter con cuerpo metálico con mecanismo de bloqueo y almacén para cuchillas de repuesto. Incluye 3 cuchillas.

Box Cutter with metal body, locking mechanism and storage for spare blades. Includes 3 blades.

Couteau à lames avec corps en métal, mécanisme de verrouillage et dépôt pour les lames de rechange. Comprend 3 lames.

Ref. **8319**

CUTER HOJA SEGURIDAD 19 MM

19 mm Security Blade Box Cutter
Couteau à lame sécurité 19 mm

New! MOD. 19S-RET



Mod.	Hoja Blade / Lame mm		Nº Art.	€
19S-RET	59x19x0,61	1	83360	9,96

- Recogida semiautomática de la cuchilla después del corte, evitando lesiones.
- After cutting, semi-automatic Blade collection, avoiding injuries.
- Ramassage semi-automatique de la lame après la coupe, pour éviter des blessures
- Mango ergonómico
- Ergonomic handle
- Poignée ergonomique
- Cambio de cuchilla rápido y sencillo. Incluye 3 cuchillas
- Quick Blade change. Includes 3 blades.
- Changement de lame rapide et facile. Comprend 3 lames.



Box-Pallet
8320
6 uds

Nº Art.	€
10174	56,79

MOD. 19S



Zamak
5

Mod.	Hoja Blade / Lame mm		Nº Art.	€
19S	60x19x0,65	1	34240	6,75

Cúter metálico con almacén para cuchillas de repuesto.

Metal Box Cutter with storage for spare blades.

Couteau à lames en métal avec dépôt pour les lames de rechange.



Ref. 8309

Ref. 8318

Ref. 8319

Ref. **8331**

CUCHILLAS REPUESTO

Spare Blades
Lames de rechange

Mod.	Hoja Blade / Lame mm		Nº Art.	€ 1 ud.
9	9	10	34241	0,31
18	18	10	34242	0,45
19S	60x19x0,65	10	34243	0,37



Mod.	Hoja Blade / Lame mm		Nº Art.	€ 1 ud.
18-ERG	18	10	83765	0,42

New!



New!



Box-Pallet
8320

20 uds

Nº Art.	€
12676	80,56



Mod.	Hoja Blade / Lame mm		Nº Art.	€ 1 ud.
19S-RET-TRA	59x19x0,61	10	83766	0,35

New!



New!



Box-Pallet
8320

20 uds

Nº Art.	€
12677	66,46



Mod.	Hoja Blade / Lame mm		Nº Art.	€ 1 ud.
19S-RET-GAN	Gancho Hook / Crochet	10	83767	0,39

New!



New!



Box-Pallet
8320

20 uds

Nº Art.	€
12682	74,52





MADERA

Wood
Bois

BROCAS

Drill Bits
Forets

268

FRESAS

Router Cutters
Fraises

285



BROCAS

Drill Bits

Forets

Ref. **1641**

BROCA PUNTA CENTRAR PRO

PRO Drill Bit
Foret auto-centreur PRO



- Óptima evacuación de viruta
- Más rápida
- Mejor centrado
- Mayor durabilidad
- Mayor precisión
- Agujeros limpios
- Optimum chipping-off
- Faster
- Better centering
- Longer tool life
- Higher precision
- Clean holes
- Evacuation optimale des copeaux
- Plus rapide
- Meilleur auto-centrage
- Vie plus longue de l'outil
- Meilleure précision
- Trous plus propres



Maderas Duras
Hard Wood
Bois dur

Maderas Tropicales
Tropical Wood
Bois Tropical

Contrachapado
Plywood
Contreplaqué

D mm	L mm	l mm	d mm		Nº Art.	€
3	61	33	3	1	34450	1,95
4	75	43	4	1	34451	2,34
5	86	52	5	1	34452	2,88
6	93	57	6	1	34453	3,33
8	117	75	8	1	34454	5,23
10	133	87	10	1	34455	7,43



Línea 33 cm
1641

BROCA PUNTA CENTRAR PRO

PRO Drill Bit
Foret auto-centreur PRO



ø	3	4	5	6	8	10
Pcs	5	5	5	5	5	5

Ref. 4995 - Nº Art. 71044: **115,81 €**



Display 52 Mixto PRO



BROCAS MULTI INOX + PARED PRO + MADERA PRO

Multi-Stainless + Concrete Pro + Wood Pro Drill Bits
Forets Multi INOX + Béton Pro + Bois Pro

Ref. 1886	∅	3	4	5	6	7	8	9	10	12	14
	Pcs	5	5	10	10	5	5	3	3	3	3
Ref. 1641	∅	3	3	4	4	5	5	6	6	8	10
	Pcs	3	2	3	2	3	2	3	2	5	5
Ref. 1004	∅	1	2	3	3,5	4	4,5	5	6	8	10
	Pcs	2	2	3	3	5	5	5	5	5	3

Ref. 4995 - N° Art. 68575: 491,16 €

Display 55



BROCAS MADERA PRO: PALA Y 3 PUNTAS

Wood Pro Drill Bits: Flat & Center Point
Forets Bois Pro: plate et auto-centreur

Ref. 1651	∅	22	24	25	26	28	30				
	Pcs	5	5	5	5	5	5				
Ref. 1651	∅	10	12	14	16	18	20				
	Pcs	5	5	5	5	5	5				
Ref. 1641	∅	3	3	4	4	5	5	6	6	8	10
	Pcs	5	5	5	5	5	5	5	5	5	5

Ref. 4995 - N° Art. 70074: 430,33 €

Display 58



BROCAS MADERA PRO 3 PUNTAS

Center Point Wood Pro Drill Bits
Forets Bois Pro auto-centreur

Ref. 1641	∅	3	3	4	4	5	5	6	6	8	10
	Pcs	5	5	5	5	5	5	5	5	5	5

Ref. 4995 - N° Art. 70088: 231,61 €

Ref. **1640**

BROCA PUNTA CENTRAR

Center Point Drill Bit
Foret auto-centreur



CrV

Maderas Blandas
Soft Wood
Bois tendre

D mm	L mm	l mm	d mm		Nº Art.	€
3	61	33	3,00	1	18426	0,68
4	75	43	4,00	1	18427	0,69
5	86	52	5,00	1	18429	0,73
6	97	60	6,00	1	18430	0,92
7	109	69	7,00	1	18432	1,00
8	117	75	8,00	1	18433	1,26
9	125	80	9,00	1	18435	1,48
10	133	87	10,00	1	18436	1,56

D mm	L mm	l mm	d mm		Nº Art.	€
11	142	89	9,95	1	30380	1,96
12	151	96	9,95	1	18438	2,15
13	151	96	9,95	1	30381	2,26
14	151	97	9,95	1	18439	2,48
15	160	100	9,95	1	30382	2,90
16	160	100	9,95	1	30383	3,31
18	180	120	9,95	1	17860	8,41
20	200	130	9,95	1	17861	10,22

Larga / Long / Longue

D mm	L mm	l mm	d mm		Nº Art.	€
6	250	200	6,00	1	55969	2,39
8	250	200	8,00	1	55970	2,72
10	250	200	10,00	1	55971	3,54
12	250	200	9,95	1	55972	4,24



Línea 1m
1640

BROCA PUNTA CENTRAR

Center Point Drill Bit
Foret auto-centreur



ø	3	4	5	6	7	8	9	10	11	12	13	14	15	16	18	20
Pcs	10	10	10	10	10	10	5	5	5	5	5	5	5	3	3	3

Ref. 4995 - Nº Art. 71047: **192,57 €**



Display 10



BROCAS MADERA PALA Y 3 PUNTAS

Flat & Center Point Wood Drill Bits

Forets Bois mèches plates & 3-pointes

Ref. 1650 (L 152)	∅	22	24	25	26	28	30	32			
	Pcs	7	5	5	5	5	5	5	5		
Ref. 1650 (L 152)	∅	6	8	10	12	14	16	18	20		
	Pcs	7	7	7	7	7	7	7	7		
Ref. 1640	∅	3	4	5	6	8	9	10	12	14	16
	Pcs	10	10	10	10	10	5	5	5	5	5

Ref. 4995 - N° Art. 22184: 339,32 €

Display 51



BROCAS METAL + PARED + MADERA

Metal + Masonry + Wood Drill Bits

Forets Métal + Maçonnerie + Bois

Ref. 1880	∅	3	4	5	6	7	8	9	10	12	14
	Pcs	10	10	10	10	10	10	5	5	5	5
Ref. 1640	∅	3	4	5	6	8	9	10	12	14	16
	Pcs	10	10	10	10	10	5	5	5	5	5
Ref. 1001	∅	1	2	3	3,5	4	4,5	5	6	8	10
	Pcs	10	10	10	10	10	10	10	5	5	3

Ref. 4995 - N° Art. 68572: 352,99 €

Display 59



BROCAS SPEED POINT + PARED + MADERA

Speed Point + Masonry + Wood Drill Bits
Forets Speed Point + Maçonnerie + Bois

Ref. 1880	∅	3	4	5	6	7	8	9	10	12	14
	Pcs	10	10	10	10	10	10	5	5	5	5
Ref. 1640	∅	3	4	5	6	8	9	10	12	14	16
	Pcs	10	10	10	10	10	5	5	5	5	5
Ref. 1002	∅	2	3	3,5	4	4,5	5	6	7	8	10
	Pcs	10	10	10	10	10	10	5	5	5	3

Ref. 4995 - N° Art. 70099: 354,32 €

Display 23



JUEGOS CASSETTE MADERA Y CONSTRUCCIÓN

Wood & Construction Cassette Sets
Jeux cassette Bois & Construction

Constr. Madera Wood / Bois	Pcs	Ref. 1485 Pared Masonry / Béton 5 Pcs.	Ref. 1486 Pared Pro Masonry Pro / Béton Pro 5 Pcs.	Ref. 1435 Madera Wood / Bois 5 Pcs.	Ref. 1438 Madera Wood / Bois 8 Pcs.
		5	5	5	5
Constr.	Pcs	Ref. 1488 Pared Masonry / Béton 8 Pcs.	Ref. 1487 Pared Pro Masonry Pro / Béton Pro 8 Pcs.	Ref. 1494 SDS plus 4 Pcs.	
		5	5	3	

Ref. 4995 - N° Art. 22372: 419,23 €

Sets 1640

BROCA PUNTA CENTRAR

Center Point Drill Bit
Foret auto-centreur



Set **1435**

5 Pcs

Cont. Ø	Nº Art.	€
4-5-6-8-10 mm	30223	6,38



Set **1438**

8 Pcs

Cont. Ø	Nº Art.	€
3-4-5-6-7-8-9-10 mm	30226	9,59



Set **1460**

9 Pcs

Cont. Ø	Nº Art.	€
3 Pcs Metal: 5-6-8 3 Pcs Madera/Wood/Bois: 5-6-8 3 Pcs Pared/Masonry/Béton 5-6-8	55610	11,24

Línea 33 cm 14S1

SETS BROCAS METAL, PARED PRO, PARED, MADERA

Metal, Concrete, Masonry, Wood Sets
Jeux Métal, Béton, Maçonnerie, Bois



	Metal Metal Métal	Pared Pro Concrete Béton	Pared Masonry Maçonnerie	Madera Wood Bois
Ref	1462-1010	1486	1485	1435
Diam	2-3-4-5-6-8 mm	4-5-6-8-10 mm	4-5-6-8-10 mm	4-5-6-8-10 mm
Pcs.	5	5	5	5

Ref. 4995 - Nº Art. 72193: 181,05 €

Ref. **1651**

BROCA PLANA GRAN RENDIMIENTO

Heavy Duty Flat Bit

Mèche plate haut rendement



Maderas Blandas
Soft Wood
Bois tendre



D mm	d mm	L mm	l mm		Nº Art.	€
6,00	6,35	152	38	1	56019	2,68
8,00	6,35	152	38	1	56021	2,68
10,00	6,35	152	38	1	56022	2,83
12,00	6,35	152	42	1	56023	3,11
13,00	6,35	152	42	1	56024	3,11
14,00	6,35	152	42	1	56025	3,24
16,00	6,35	152	42	1	56026	3,24
18,00	6,35	152	42	1	56028	3,99
19,00	6,35	152	42	1	56029	3,99
20,00	6,35	152	42	1	56030	3,99
22,00	6,35	152	42	1	56031	3,99
24,00	6,35	152	46	1	56032	4,97
25,00	6,35	152	46	1	56033	4,97
26,00	6,35	152	46	1	56034	4,97
28,00	6,35	152	46	1	56035	6,38
30,00	6,35	152	46	1	56036	6,73
32,00	6,35	152	46	1	56037	6,73
35,00	6,35	152	46	1	56038	7,78
38,00	6,35	152	46	1	56040	8,82
40,00	6,35	152	46	1	56042	8,88



Set **1651**

8 Pcs

Cont. Ø	Nº Art.	€
12-16-18-20-22- 25-28-32 mm	57449	36,37

Línea 1m
1651

BROCA PLANA GRAN RENDIMIENTO

Heavy Duty Flat Bit

Mèche plate haut rendement



43
cm



Ø	6	8	10	12	14	16	18	20	22	24	25	26	28	30	32	35	38	L305
Pcs	8	8	8	8	8	8	8	8	5	5	5	5	5	5	5	5	5	1

Ref. 4995 - Nº Art. 72169: 493,57 €

Ref. **1653**

ALARGADOR

Extension

Rallonge



L mm	d mm	D mm		Nº Art.	€
305	6,35	15,85	1	23982	10,90

Display 55



BROCAS MADERA PRO: PALA Y 3 PUNTAS

Wood Pro Drill Bits: Flat & Center Point

Forets Bois Pro: Plate et auto-centreur

Ref. 1651	∅	22	24	25	26	28	30				
	Pcs	5	5	5	5	5	5	5	5		
Ref. 1651	∅	10	12	14	16	18	20				
	Pcs	5	5	5	5	5	5	5	5		
Ref. 1641	∅	3	3	4	4	5	5	6	6	8	10
	Pcs	5	5	5	5	5	5	5	5	5	5

Ref. 4995 - N° Art. 70074: 430,33 €

Display 56



BROCAS MADERA PRO: PALA

Wood Pro Drill Bits: Flat

Forets Bois Pro: Plate

Ref. 1651	∅	10	12	14	16	18	20		
	Pcs	10	10	10	10	10	10	10	10

Ref. 4995 - N° Art. 70078: 203,90 €

Display 57



BROCAS MADERA PRO: PALA

Wood Pro Drill Bits: Flat

Forets Bois Pro: Plate

Ref. 1651	∅	22	24	25	26	28	30		
	Pcs	5	5	5	5	5	5	5	5

Ref. 4995 - N° Art. 70084: 160,04 €

Ref. **1650**

BROCA PLANA

Flat Bit
Mèche plate



Pala
Flat
Plate



Maderas Blandas
Soft Wood
Bois tendre



Larga / Long / Longue

D mm	L mm	l mm	d mm		Nº Art.	€
6	152	38	6,35	1	30384	1,62
8	152	38	6,35	1	30385	1,62
10	152	38	6,35	1	30386	1,71
12	152	42	6,35	1	30387	1,88
13	152	42	6,35	1	55988	1,93
14	152	42	6,35	1	18457	1,96
16	152	42	6,35	1	18459	2,15
17	152	42	6,35	1	55989	2,29
18	152	42	6,35	1	18460	2,42
19	152	42	6,35	1	55990	2,42
20	152	42	6,35	1	18462	2,42
22	152	42	6,35	1	18463	2,81
24	152	46	6,35	1	18465	3,01
25	152	46	6,35	1	18466	3,41
26	152	46	6,35	1	18468	3,58
28	152	46	6,35	1	18469	3,86
30	152	46	6,35	1	18471	4,07
32	152	46	6,35	1	18472	4,35
35	152	46	6,35	1	55992	4,88
36	152	46	6,35	1	30389	5,02
38	152	46	6,35	1	30390	5,35
40	152	46	6,35	1	17864	5,37

D mm	L mm	l mm	d mm		Nº Art.	€
6	400	38	6,35	1	55973	6,82
8	400	38	6,35	1	55974	6,82
10	400	38	6,35	1	55975	7,14
12	400	42	6,35	1	55976	7,90
14	400	42	6,35	1	55977	6,79
16	400	42	6,35	1	55978	7,46
18	400	42	6,35	1	55979	8,41
20	400	42	6,35	1	55980	8,41
22	400	42	6,35	1	55981	9,74
24	400	46	6,35	1	55982	10,44
25	400	46	6,35	1	55983	11,90
28	400	46	6,35	1	55984	13,40
30	400	46	6,35	1	55985	14,13
32	400	46	6,35	1	55986	15,18
35	400	46	6,35	1	55987	17,04



Set **1650**

8 Pcs

Cont. Ø	Nº Art.	€
12-16-18-20-22- 25-28-32 mm	66378	23,30



Línea 1m 1650

BROCA PLANA

Flat Bit
Mèche plate



∅	6	8	10	12	14	16	18	20	22	24	25	26	28	30	32	36	38	L305
Pcs	10	10	10	10	10	10	10	10	5	5	5	5	5	5	5	5	5	1

Ref. 4995 - N° Art. 71051: 346,16 €

Display 10

BROCAS MADERA PALA Y 3 PUNTAS

Flat & Center Point Wood Drill Bits
Forets Bois mèches plates & 3-pointes



Ref. 1650 (L 152)	∅	22	24	25	26	28	30	32			
	Pcs	7	5	5	5	5	5	5			
Ref. 1650 (L 152)	∅	6	8	10	12	14	16	18	20		
	Pcs	7	7	7	7	7	7	7	7		
Ref. 1640	∅	3	4	5	6	8	9	10	12	14	16
	Pcs	10	10	10	10	10	5	5	5	5	5

Ref. 4995 - N° Art. 22184: 339,32 €



Ref. **1655**

BROCA ESPIRAL TORNILLO EN LA PUNTA

Screw-Point Auger Drill Bit
Foret spirale vis en pointe



CrV

Maderas Duras
Hard Wood
Bois dur

	D mm	L mm	l mm	d mm		Nº Art.	€		D mm	L mm	l mm	d mm		Nº Art.	€		D mm	L mm	l mm	d mm		Nº Art.	€	
New!	3	230	155	2,5	1	19792	9,18		6	460	385	5,5	1	60683	12,06		8	600	530	7,5	1	67750	18,00	
New!	4	230	155	3,5	1	19793	9,47		8	460	385	7,5	1	19082	12,71		10	600	530	9,5	1	15811	21,08	
New!	5	230	155	4,5	1	19794	9,75		10	460	385	9,5	1	19151	13,84		12	600	530	11,5	1	15813	21,70	
	6	230	155	5,5	1	19139	10,04		12	460	385	11,5	1	19163	15,00		14	600	530	12,5	1	15816	30,81	
	7	230	155	6,5	1	66809	10,32		14	460	385	12,5	1	19181	18,36		16	600	530	12,5	1	15817	36,18	
	8	230	155	7,5	1	19145	10,59		16	460	385	12,5	1	19193	21,75		18	600	530	12,5	1	15823	54,51	
	9	230	155	8,5	1	66811	10,90		18	460	385	12,5	1	19205	29,11		20	600	530	12,5	1	15828	62,22	
	10	230	155	9,5	1	19148	11,18		20	460	385	12,5	1	19217	32,64		22	600	530	12,5	1	15855	69,60	
	11	230	155	10,5	1	66812	11,42		22	460	385	12,5	1	19229	35,90									
	12	230	155	11,5	1	19154	11,63		24	460	385	12,5	1	19238	39,36									
	13	230	155	12,5	1	66813	11,97		26	460	385	12,5	1	27603	42,75									
	14	230	155	12,5	1	19172	12,31		28	460	385	12,5	1	27605	46,32									
	16	230	155	12,5	1	19187	14,11		30	460	385	12,5	1	27680	50,82									
	18	230	155	12,5	1	19202	17,97		32	460	385	12,5	1	29041	56,48									
	20	230	155	12,5	1	19211	20,41																	
	22	230	155	12,5	1	19226	22,79																	
	23	230	155	12,5	1	66814	23,89																	
	24	230	155	12,5	1	19235	25,01																	
	25	230	155	12,5	1	66815	26,14																	
	26	230	155	12,5	1	27304	27,28																	
	28	230	155	12,5	1	27604	32,20																	
	30	230	155	12,5	1	27630	46,08																	
	32	230	155	12,5	1	29040	46,08																	



New!

Set **1655**

9 Pcs

Cont. Ø	Nº Art.	€
4-5-6-8-10-12-14-16-18-mm	19795	107,05

Línea 1m
1655

BROCA ESPIRAL TORNILLO EN LA PUNTA

Screw-Point Auger Drill Bit
Foret spirale vis en pointe



Ø	6	7	8	9	10	11	12	13	14	16	18	20	22	23	24	25	26	28	30
Pcs	2	2	2	2	2	2	2	2	2	2	2	2	1	1	1	1	1	1	1

Ref. 4995 - Nº Art. 72171: **509,03 €**

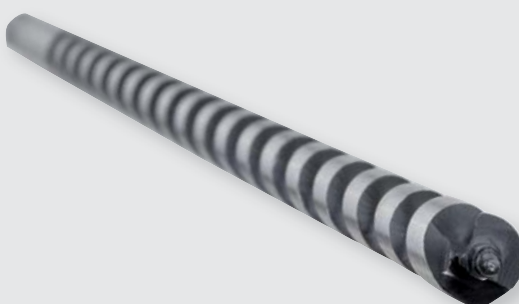

Display 11

BROCA ESPIRAL TORNILLO EN LA PUNTA

Screw-Point Auger Drill Bit

Foret spirale vis en pointe



∅	18 L460	20 L460	22 L460	24 L460	26 L460	28 L460	30 L460	32 L460
Pcs	2	2	1	1	1	1	1	1
∅	26 L230	28 L230	30 L230	32 L230	10 L460	12 L460	14 L460	16 L460
Pcs	1	1	1	1	2	2	2	2
∅	10 L230	12 L230	14 L230	16 L230	18 L230	20 L230	22 L230	24 L230
Pcs	2	2	2	2	2	2	1	1

Ref. 4995 - N° Art. 22307: 907,67 €

Display 38



39
cm

∅	10 L230	12 L230	14 L230	16 L230	18 L230	20 L230	22 L230	24 L230
Pcs	2	2	2	2	2	2	1	1

Ref. 4995 - N° Art. 22624: 222,99 €

Display 39



62
cm

∅	26 L230	28 L230	30 L230	32 L230	10 L460	12 L460	14 L460	16 L460
Pcs	1	1	1	1	2	2	2	2

Ref. 4995 - N° Art. 22626: 289,55 €

Display 40



62
cm

∅	18 L460	20 L460	22 L460	24 L460	26 L460	28 L460	30 L460	32 L460
Pcs	2	2	1	1	1	1	1	1

Ref. 4995 - N° Art. 22627: 395,13 €

Ref. **1644**

BROCA ENCOFRADO MADERA SDS PLUS

SDS PLUS WOOD Cavity Drill Bit
Foret coffrage BOIS SDS PLUS

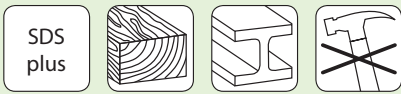

Aceros
Steel
Aciers

Madera
Wood
Bois

D mm	L mm	I mm		Nº Art.	€
10	400	87	1	15447	19,89
12	400	100	1	15450	21,41
14	400	100	1	15453	27,94
16	400	100	1	15460	35,29
18	400	100	1	15507	46,11
20	400	100	1	15576	50,95
22	400	100	1	15579	58,90
24	400	100	1	15582	75,01
26	400	100	1	15603	88,87
28	400	100	1	15621	95,47
30	400	100	1	15627	105,96

D mm	L mm	I mm		Nº Art.	€
10	600	87	1	15660	20,63
12	600	100	1	15669	23,01
14	600	100	1	15780	30,85
16	600	100	1	15781	38,16
18	600	100	1	15783	49,09
20	600	100	1	15784	53,89
22	600	100	1	15793	61,87
24	600	100	1	15799	77,93
26	600	100	1	15801	91,89
28	600	100	1	15807	98,42
30	600	100	1	15808	109,02

Línea 1m
1644

BROCA ENCOFRADO MADERA SDS PLUS L400

L400 SDS PLUS WOOD Cavity Drill Bit
Foret coffrage BOIS SDS PLUS L400



Ø	10 L400	12 L400	14 L400	16 L400	18 L400	20 L400	22 L400	24 L400	26 L400	28 L400	30 L400
Pcs	1	1	1	1	1	1	1	1	1	1	1

Ref. 4995 - Nº Art. 72174: **625,80 €**

Línea 1m
1644

BROCA ENCOFRADO MADERA SDS PLUS L600

L600 SDS PLUS WOOD Cavity Drill Bit
Foret coffrage BOIS SDS PLUS L600



Ø	10 L600	12 L600	14 L600	16 L600	18 L600	20 L600	22 L600	24 L600	26 L600	28 L600	30 L600
Pcs	1	1	1	1	1	1	1	1	1	1	1

Ref. 4995 - Nº Art. 72175: **654,78 €**

Ref. **1643**

BROCA ENCOFRADO MADERA

WOOD Cavity Drill Bit
Foret coffrage BOIS



Aceros
Steel
Aciers

Madera
Wood
Bois



D mm	L mm	l mm	d mm		Nº Art.	€
6	400	57	5	1	23988	10,26
8	400	75	6	1	23989	10,34
10	400	87	8	1	23990	12,12
12	400	100	8	1	23991	15,54
14	400	100	8	1	23992	18,63
16	400	100	10	1	23993	22,13
18	400	100	10	1	23994	29,14
20	400	100	10	1	23995	33,80
22	400	100	10	1	23996	45,23
24	400	100	11	1	23997	53,16
26	400	100	11	1	23999	61,14
28	400	100	11	1	24000	65,15
30	400	100	11	1	24001	72,84

D mm	L mm	l mm	d mm		Nº Art.	€
6	600	57	5	1	24002	11,00
8	600	75	6	1	24004	11,07
10	600	87	8	1	24005	12,92
12	600	100	8	1	24006	16,26
14	600	100	8	1	24007	19,55
16	600	100	10	1	24008	23,31
18	600	100	10	1	24009	30,81
20	600	100	10	1	24010	35,20
22	600	100	10	1	24011	47,66
24	600	100	11	1	24012	58,93
26	600	100	11	1	24013	63,63
28	600	100	11	1	24014	67,61
30	600	100	11	1	24015	76,25

Display
41



54
cm

Display
42



74
cm

∅	6	8	10	12	14	16	18	20
	L400	L400	L400	L400	L400	L400	L400	L400
Pcs	2	2	2	2	2	2	2	2

Ref. 4995 - Nº Art. 22629: **303,90 €**

∅	6	8	10	12	14	16	18	20
	L600	L600	L600	L600	L600	L600	L600	L600
Pcs	2	2	2	2	2	2	2	2

Ref. 4995 - Nº Art. 22630: **320,24 €**

Ref. **1621**

BROCA MADERA

Wood Drill Bit
Foret Bois

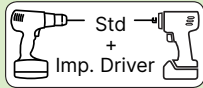

Maderas Blandas
Soft Wood
Bois tendre

D mm	L mm	l mm	d mm	📦	Nº Art.	€
3,00	64	32	6,35	1	56002	3,05
4,00	74	40	6,35	1	56004	2,83
5,00	85	49	6,35	1	56005	2,69
6,00	89	57	6,35	1	56006	2,58
8,00	90	55	6,35	1	56008	2,77

Línea 33 cm
1621

BROCA MADERA

Wood Drill Bit
Foret Bois



∅	3	4	5	6	8
Pcs	5	5	5	5	5

Ref. 4995 - Nº Art. 72201: **69,56 €**

Ref. **1461**

SET BROCAS MANGO HEXAGONAL 1/4" Y PUNTAS DE ATORNILLAR

Hexagonal Shank Drill Bit and Screwdriver Bit Set
Jeu de forets hexagonales et embouts vissage



6 Sets

Nº Art. €
19291 **111,89**



Set 17 Pcs

Nº Art.	€
81601	19,63



Brocas Madera
Wood Drill Bits
Forets Bois
3-4-5-6 mm

d mm: 6,35
Tx
T10
T15
T20
T25
T30
T40

PH d mm: 6,35
PH1
PH2
PH3
↳-25 mm-↳

PZ d mm: 6,35
PZ1
PZ2
PZ3
↳-25 mm-↳

Adapt. Quick-Lock
INOX/Stainless
L mm: 60 - d mm: 6,35



Display 54



BROCAS METAL + PARED + MADERA

Metal + Masonry + Wood Drill Bits
Forets Métal + Maçonnerie + Bois

		Ref. 1611							
∅		2	3	3,25	3,5	4	5	6	8
Pcs		3	3	3	3	3	3	3	3

		Ref. 1610					Ref. 1601		
∅		M3	M4	M5	M6	M8	M10	4	5
Pcs		2	2	2	2	2	2	3	3

		Ref. 1601			Ref. 1621				
∅		6	8	10	3	4	5	6	8
Pcs		3	3	3	3	3	3	3	3

Ref. 4995 - N° Art. 69804: 430,06 €

Ref. 1639

AVELLANADOR MADERA

Shell Drill Bit
Foret outil-lamer-chambrer Bois



HSS



También posible uso como tope para brocas
Also usable as a drill stop
Utilisable comme bague d'arrêt pour forets

D- mm	D+ mm		N° Art.	€
3	16	1	56011	6,91
4	16	1	56012	6,91
5	16	1	56013	6,91
6	16	1	56014	6,91
8	20	1	56016	8,59
10	20	1	56018	8,59



Línea 33 cm 1639

AVELLANADOR MADERA

Shell Drill Bit
Foret outil-lamer-chambrer Bois



∅	3x16	4x16	5x16	6x16	8x20	10x20
Pcs	2	2	2	2	2	2

Ref. 4995 - N° Art. 72160: 89,63 €



Ref. **1637**

TOPE PROFUNDIDAD DE BROCA

Drill Bit Depth Stop
Butées de perçage

New!



C45

D mm		Nº Art.	€
3,00	1	13762	2,46
4,00	1	13763	2,76
5,00	1	13764	3,01
6,00	1	13765	3,37
8,00	1	13766	3,58
10,00	1	13767	3,79

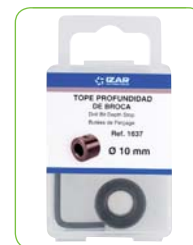

Set 6 Pcs

Cont. Ø	Nº Art.	€
3-4-5-6-8-10 mm	81689	18,96

Ref. **1461**

SET TOPES DE PROFUNDIDAD DE BROCAS

Drill Bit Depth Stop Set
Jeu butées de perçage



13
pcs

Brocas Metal
Metal Drill Bits
Forets métal
3-4-5-6-8-10 mm

Topes de profundidad
Depth Stops
Butées de perçage



Nº Art. €
79876 30,14

Llave Allen / Allen Wrench / Clé Allen 1 pc

FRESAS

Router Cutters

Fraises

Ref. **1685**

FRESA RANURADO Y COPIADO CON CENTRADOR

Straight Bit with Centre Tip
Fraise rainurage et copiage avec pointe



MD
HM
Carbure

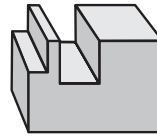

D mm	d mm	L mm	H mm		Nº Art.	€
3,00	8,00	37,0	6	1	69222	20,37
4,00	8,00	41,0	10	1	69225	20,37
5,00	8,00	43,0	12	1	69228	21,90
6,00	8,00	48,0	14	1	69231	21,90

D mm	d mm	L mm	H mm		Nº Art.	€
8,00	8,00	51,0	20	1	69234	22,74
10,00	8,00	50,0	20	1	69237	22,74
12,00	8,00	50,0	20	1	69240	24,39

Ref. **1669**

FRESA RANURADO Y COPIADO

Straight Bit
Fraise rainurage et copiage



MD
HM
Carbure

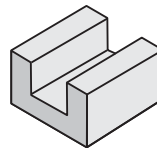

D mm	d mm	L mm	H mm		Z		Nº Art.	€
3,00	8,00	47,0	11,0	1	1	36312	17,71	
4,00	8,00	47,0	11,0	1	1	36313	17,71	
5,00	8,00	47,0	11,0	1	1	36314	19,05	
6,00	8,00	48,0	16,0	2	1	36315	19,05	
8,00	8,00	51,0	20,0	2	1	36316	19,78	
10,00	8,00	51,0	20,0	2	1	36317	19,78	
12,00	8,00	51,0	20,0	2	1	36318	21,21	

D mm	d mm	L mm	H mm		Z		Nº Art.	€
14,00	8,00	51,0	20,0	2	1	36319	22,77	
16,00	8,00	51,0	20,0	2	1	36320	24,51	
18,00	8,00	51,0	20,0	2	1	36321	25,44	
20,00	8,00	51,0	20,0	2	1	36322	27,61	
22,00	8,00	59,0	25,0	2	1	36323	28,70	
24,00	8,00	43,5	11,5	2	1	36324	29,46	

Ref. **1679**

FRESA REBAJADO CON COPIADOR

Rabbeting Bit
Fraise réduction avec copieur



MD
HM
Carbure

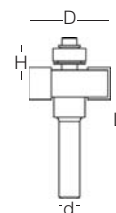
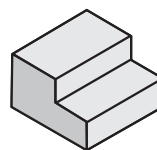

D mm	d mm	L mm	H mm		Nº Art.	€
28,50	8,00	54,0	12,7	1	69279	34,30

Ref. **1678**

FRESA REFUNDIDO RECTO CON COPIADOR

Flush Trim Bit
Fraise fusionage droit avec copieur



MD
HM
Carbure

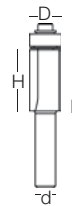
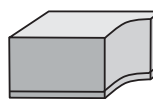
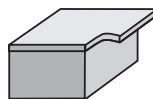

D mm	d mm	L mm	H mm		Nº Art.	€
12,70	8,00	70,0	25,4	1	36343	26,90

Ref. **1674**

FRESA RANURAS EN "V"

"V" Grooves Bit
Fraise rainures "V"



MD
HM
Carbure

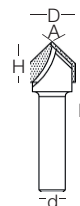
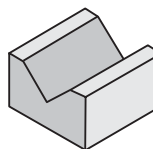

D mm	d mm	L mm	H mm	A		Nº Art.	€
12,70	8,00	45,0	12,7	90°	1	60757	22,14
16,00	8,00	46,0	12,7	90°	1	69212	24,99
19,00	8,00	51,0	16,0	90°	1	69214	29,54

Ref. **1676**

FRESA COLA DE MILANO CON PRECORTADOR

Dovetail Bit
Fraise queue d'aronde avec precoupeur



MD
HM
Carbure

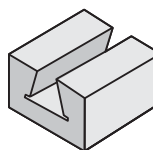

D mm	d mm	L mm	H mm	A		Nº Art.	€
12,70	8,00	45,0	12	14°	1	60758	33,31

Ref. **1677**

FRESA BISELADO CON COPIADOR

Bevel Trim Bit
Fraise biseautage avec copieur



MD
HM
Carbure

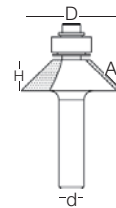
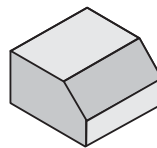

D mm	d mm	L mm	H mm	A		Nº Art.	€
31,80	8,00	56,0	15	45°	1	36356	31,22

Ref. **1670**

FRESA RADIO CÓNCAVO

Core Box Bit
Fraise rayon concave



MD
HM
Carbure

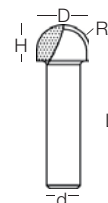
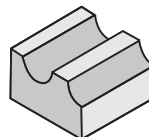

D mm	d mm	L mm	H mm	R		Nº Art.	€
9,50	8,00	40,0	9,5	4,8	1	36328	27,41
12,70	8,00	40,0	12,7	6,3	1	36329	29,26

Ref. **1671**

FRESA RADIO CÓNCAVO CON COPIADOR

Cove Bit
Fraise rayon concave avec copieur



MD
HM
Carbure

3 Z

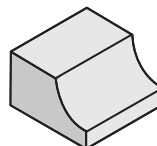

D mm	d mm	L mm	H mm	R		Nº Art.	€
28,50	8,00	55,0	14	9,5	1	60759	42,09
35,00	8,00	58,0	16	12,7	1	60760	49,94

Ref. **1672**

FRESA REDONDEADO CANTOS CON COPIADOR

Beading Bit
Fraise arrondir les bouts avec copieur



MD
HM
Carbure

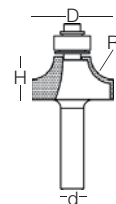
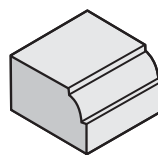

D mm	d mm	L mm	H mm	R		Nº Art.	€
25,40	8,00	54,0	13,5	6,3	1	36332	46,01
28,60	8,00	55,0	15,9	7,9	1	36333	48,54
31,80	8,00	56,0	16,7	9,5	1	36334	52,24
38,10	8,00	59,0	19,0	12,7	1	36335	60,78

Ref. **1673**

FRESA REDONDEADO CANTOS CON COPIADOR

Round Over Bit
Fraise arrondir les bouts avec copieur



MD
HM
Carbure

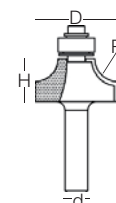
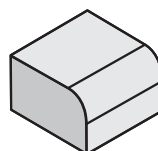

D mm	d mm	L mm	H mm	R		Nº Art.	€
25,40	8,00	55,0	13,5	6,3	1	36336	46,01
28,60	8,00	56,0	15,9	7,9	1	36337	48,54
31,80	8,00	57,0	16,7	9,5	1	36338	52,24
38,10	8,00	60,0	19,0	12,7	1	36339	60,78

Ref. **1681**

FRESA PERFILADO CON COPIADOR

Roman Ogee Bit
Fraise profilage avec copieur



MD
HM
Carbure

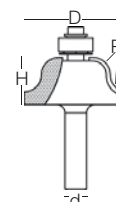
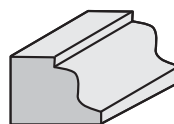

D mm	d mm	L mm	H mm	R		Nº Art.	€
35,00	8,00	60,0	17,4	6,30	1	60762	65,40

Ref. **1682**

FRESA PERFILADO

Classical Roman Ogee Bit
Fraise profilage



MD
HM
Carbure

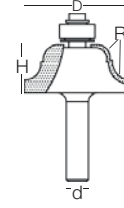
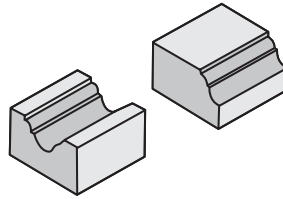

D	d	L	H	R		N°	€
mm	mm	mm	mm			Art.	
35,00	8,00	56,0	15,9	4,80	1	60763	43,70

Ref. **1686**

FRESA PERFILADO

Ogee Bit
Fraise profilage



MD
HM
Carbure

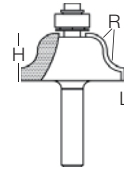
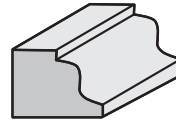

D	d	L	H	R		N°	€
mm	mm	mm	mm			Art.	
31,80	8,00	54,0	12,7	4,8	1	69699	51,13
38,00	8,00	57,0	15,9	6,3	1	69701	58,43



Línea 1m 16FM

FRESAS MADERA

Wood Router Cutters
Fraises Bois



Ref.	1669	1669	1669	1669	1669	1669	1669	1670	1670	1674	1674	1676	1677	1678	1679	1686	1681	1682	1685
∅	5	6	8	10	12	14	16	9,5	12,7	12,7	16	12,7	31,80	12,7	28,5	31,8	34,90	35	12
Pcs	1	1	1	1	1	1	1	1	1	1	1	1	1	1	1	1	1	1	1

Ref. 4995 - N° Art. 72181: 560,31 €

Display 64

FRESAS MADERA

Wood Router Cutters
Fraises Bois



Ref.	1669	1669	1669	1669	1669	1669
∅	5	6	8	10	12	14
Ref.	1669	1670	1670	1671	1671	1672
∅	16	9,5	12,7	28,5	35	28,6
Ref.	1672	1672	1673	1673	1673	1674
∅	31,8	38,1	28,6	31,8	38,1	12,7
Ref.	1674	1676	1677	1678	1679	1681
∅	16	12,7	31,80	12,7	28,5	34,90
Ref.	1686	1682	1685	1685	1685	1685
∅	31,8	35	6	8	10	12

N° Art. 39710: 1.042,80 €

Ref. **1615**

BROCA-FRESA INSTALADORES

TCT Hinge Boring Bit
Mèche à façonner installateurs



Diente MD
Carbide Tipped
Dent Carbure



RPM
Max.
800-1000

Maderas Duras
Hard Wood
Bois dur

Maderas Blandas
Soft Wood
Bois tendre

Indicado carpinteros y ebanistas, para instalación de ventanas, puertas y cocinas en todo tipo de maderas y materiales abrasivos.

Suitable for carpenters and cabinet-makers installing windows, doors & kitchens in all wood types and abrasive materials.

Idéal pour charpentiers et menuisiers pour installation de fenêtres, portes et cuisines tout genre de surfaces et matériaux abrasifs.

D mm	d mm	L mm	l mm		Nº Art.	€
15	8	90	10,00	1	23039	12,91
18	8	90	10,00	1	23040	15,34
20	8	90	12,50	1	23041	16,86
22	8	90	12,50	1	23042	18,41
24	8	90	12,50	1	23043	20,28
25	8	90	12,50	1	23044	21,15
26	8	90	14,50	1	23045	21,91
30	8	90	14,50	1	23046	24,04
35	10	90	14,50	1	23047	28,84
40	10	90	16,50	1	23048	32,83

Línea 33 cm
1615

BROCA-FRESA INSTALADORES

TCT Hinge Boring Bit
Mèche à façonner installateurs

21
cm



ø	20	25	26	35
Pcs	2	2	2	2

Ref. 4995 - Nº Art. 72183: 177,53 €



Ref. **1620**

BROCA-FRESA MADERA

WOOD Forstner Bit
Mèche a façonner BOIS



C60

RPM
Max.
800

Maderas Duras
Hard Wood
Bois dur

Maderas Blandas
Soft Wood
Bois tendre



Apropiado para todo tipo de maderas naturales, blandas y nobles.

Ideal for use in all natural soft and hard woods.

Idéal pour tout genre de bois naturels, tendres et nobles.

D mm	d mm	L mm	l mm		Nº Art.	€
10	9,50	93	8,50	1	18189	5,70
12	9,50	93	9,00	1	18190	5,88
14	9,50	93	9,00	1	18192	6,19
15	9,50	93	9,50	1	18193	6,29
16	9,50	93	9,50	1	18195	6,38
18	9,50	93	10,00	1	18196	7,62
20	9,50	93	10,50	1	18198	7,05
22	9,50	93	11,00	1	18199	8,02
24	9,50	93	11,50	1	18201	8,22
25	9,50	93	11,50	1	18202	8,34

D mm	d mm	L mm	l mm		Nº Art.	€
26	9,50	93	11,50	1	18204	9,02
28	9,50	93	12,50	1	18205	7,82
30	9,50	93	13,00	1	18206	7,82
32	9,50	93	13,00	1	18207	10,26
34	9,50	93	13,50	1	18208	10,82
35	9,50	93	13,50	1	18210	11,18
40	9,50	95	15,50	1	18213	12,68
45	9,50	95	16,00	1	18214	14,25
50	9,50	95	17,50	1	18216	15,49



New!

8 Pcs

Cont. Ø	Nº Art.	€
15-20-25-30-35-40-45-50 mm	24630	83,09

Línea 33 cm
1620

BROCA-FRESA MADERA

WOOD Forstner Bit
Mèche a façonner BOIS



21 cm

ø	16	20	26	35	40
Pcs	2	2	2	2	2

Ref. 4995 - Nº Art. 72185: 92,62 €

Ref. **1625**

BROCA-FRESA BISAGRAS

Cantilever Hinge Bit
Mèche à façonner charnières



MD
HM
Carbure

D mm	d mm	L mm	l mm		Nº Art.	€
26	8	54	7,50	1	24476	19,92
30	8	54	8,00	1	24477	19,92
35	8	54	8,20	1	24478	20,39



Línea 33 cm
1625

BROCA-FRESA BISAGRAS

Cantilever Hinge Bit
Mèche à façonner charnières



20 cm

ø	26	30	35
Pcs	2	2	2

Ref. 4995 - Nº Art. 72187: 120,45 €

Ref. **1689**

FRESA ESPUMAS EVA* Y MADERA

EVA Foam & Wood End Mill
Fraise caoutchouc EVA et Bois



MD
HM
Carbure

IZAR
Std.

2
Dientes
Teeth/Dents

*** Etilvinilacetato**
Ethylene-vinyl acetate
Éthylène-acétate de vinyle

Espumas EVA
Foam
Caoutchouc

Madera
Wood
Bois

Plásticos
Plastics
Plastiques

D mm	d mm	L mm	l mm	Z		Nº Art.	€
01,00	3	38	3	2	1	79346	9,21
01,50	3	38	7	2	1	79421	9,21
02,00	3	38	17	2	1	79422	9,21
02,50	3	38	17	2	1	79423	9,21
03,00	3	55	32	2	1	79435	10,39
04,00	4	65	42	2	1	79436	19,47
06,00	6	70	42	2	1	79437	25,61
08,00	8	75	42	2	1	79438	40,00
10,00	10	85	42	2	1	79440	76,22



- **Geometría Multi Material válida para una amplia gama de productos como espumas, acrílicos, PVC, ABS, tableros, madera contrachapada, resinas, nylon, etc.**
- **Special Multi Material geometry suitable for a wide range of products such as foams, acrylic, PVC, ABS, hardwood, plywood, resins, nylon, etc.**
- **Géométrie Multi Matériaux pour une gamme large de produits comme mousses, acryliques, PVC, ABC, tableaux, bois contreplaqués, résines, nylon, etc.**
- **Mecanizado de las bandejas de herramientas.**
- **Machining of tool trays.**
- **Usinage de plateaux d'outils.**



Ref. **9001**

BROCA-FRESA ROTOZIP® / ROTOCUT® METAL

Metal Rotozip® / Rotocut® Cutout Bit
Foret-Fraise Rotozip® / Rotocut® Métal



MD
HM
Carbure



Chapas finas de metal
Thin metal sheets
Tôles fines

D mm	Pulgadas Inches / Pouces	L	l		Z		Nº Art.	€
3,97	5/32	50,00	11	2	2	67805	18,30	

Ref. **7009**

BROCA-FRESA ROTOZIP® / ROTOCUT® CERÁMICAS

Ceramic Rotozip® / Rotocut® Cutout Bit
Foret-Fraise Rotozip® / Rotocut® Céramique



MD
HM
Carbure



Argamasa, Azulejos Cerámica, Estuco, Mármol, Placas Cemento, Yeso

Concrete Panels, Ceramic Tiles, Marble, Mortar, Plaster, Stucco
Mortier, Carreaux Faïence Céramique, Stuc, Marbre, Plaques de ciment, Plâtre

D mm	Pulgadas Inches / Pouces	L	I		Nº Art.	€
3,18	1/8	45,00	21,00	1	18933	17,38
6,35	1/4	50,00	20,50	1	18939	29,14



Ref. **7002**

BROCA-FRESA ROTOZIP® / ROTOCUT® ESCAYOLA

Drywall Rotozip® / Rotocut® Cutout Bit
Foret-Fraise Rotozip® / Rotocut® Plâtre





HSS

Pladur

Escayola
Drywall
Plâtre

Escayola, Muros Prefabricados

Drywall, Prefabricated Walls
Plâtre, Murs Préfabriqués

D mm	Pulgadas Inches / Pouces	L	I			Nº Art.	€
3,18	1/8	58,00	35,00	3	2	18927	4,34



Ref. **7003**

BROCA-FRESA ROTOZIP® / ROTOCUT® AUTO-GUÍA

Autocenter Rotozip® / Rotocut® Cutout Bit
Foret-Fraise Rotozip® / Rotocut® auto-centré



HSS

Auto-center

Escayola, Espuma, Muros Prefabricados
Drywall, Foam, Prefabricated Walls
Plâtre, Mousse, Murs Préfabriqués

D mm	Pulgadas Inches / Pouces	L	I	Z	Nº Art.	€
3,18	1/8	60,00	35,00	1	2	19002 4,34
3,97	5/32	75,00	40,00	1	2	67795 5,57
6,35	1/4	82,00	44,00	1	1	18930 9,71



Ref. **7001**

BROCA-FRESA ROTOZIP® / ROTOCUT® MADERA

Wood Rotozip® / Rotocut® Cutout Bit
Foret-Fraise Rotozip® / Rotocut® Bois



HSS



Aglomerado, Aluminio, Espuma, Fibra Vidrio, Laminados, Plástico, Plexiglás, Vinilo
Aluminium, Chipboard, FibreGlass, Foam, Laminated, Plastics, Plexiglas, Vinyl
Agglomérat, Aluminium, Mousse, Fibre de Verre, Laminés, Plastiques, Plexiglas, Vinyle

D mm	Pulgadas Inches / Pouces	L	I	Z	Nº Art.	€
3,18	1/8	70,00	35,00	1	2	18999 4,34



Ref. **1690**

CUCHILLA CEPILLOS ELÉCTRICOS

Planner Blade
Lame à surfacer

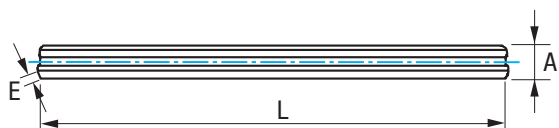

MD
HM
Carbure



L	A	E		N°	€
mm	mm	mm	Art.		
82	5,5	1,10	2	60635	3,79 *

* € = 1 ud.





SIERRAS

Saw Blades

Lames scies

OSCILANTES MULTI-FUNCIÓN

Oscillating Multi-Tools

Outils multifonction

298

SIERRAS SABLE

Sabre Saw Blades

Lames scie sabre

320

SIERRAS CALAR

Jig Saw Blades





















































Lames scies sauteuses

336



CUADRO USO SIERRAS OSCILANTES MULTI-FUNCIÓN

Oscillating Multi-Tool Table
Tableau utilisation outils multifonction

		STARLOCK															
		MADERA - Wood - Bois							METAL								
		Ref.	2940	2940	2940	2940	2940	2940	2940	2910	2910	2910	2910	2910	2910	2910	2910
Mod.	00010	00020	00030	00040	00050	00060	00070	00010	00020	00030	00040	00050	00060	00070	00080	00090	00100
Mat.	HCS	HCS	Bimetal	HCS	HCS	Bimetal	HCS	MD HM	MD HM	Bimetal	Bimetal	Bimetal	Bimetal	Bimetal	Bimetal	Bimetal	Bimetal + TIN
																	
																	
	Madera Blanda Soft Wood / Bois tendre	●	○	○	●	○	○	●	○	○	○	○	○	○	○	○	○
	Madera Dura Hard Wood / Bois dur		●	●		●	●			○	○	○	○	○	○	○	○
	Madera+Clavos Wood+Nails / Bois+Clous							○	○		○		○	○			
	Metal							○	○	○	○	○	○	○	○	○	○
	INOX / Stainless / Inox							○	○				○				
	Plástico / Plastics / Plastique	○			○		○			○	○	○		○	○	○	○
	Fibra Vidrio Fibreglass / Fibre verre							○	○								
	Abrasivos Abrasive / Abrasifs							○	○								
	Pladur / Drywall / Plâtre							○	○	○	○	○					
	No ferrosos Non-ferrous / Non ferreux									○	○	○	○				
	Perfiles / Profiles / Profils														○	○	○
	Parquet-Laminados Laminated-Parquet Parquet-Laminés														○	○	
	GFK																○
	Cerámica Ceramics / Céramique																
	Grout-Mortero Grout-Mortar Coulies-Mortier																
	Pulido / Sanding / Poncer																
	Aislamiento Isolating / Isolant																
	Caucho Rubber / Caoutchouc																
	Cuero / Leather / Cuir																
	Restos blandos (pegamento, moqueta, silicona...) Soft remains (glue, carpet, silicone...) Restes tendres (colle, moquette, silicone...)																

OSCILANTES MULTI-FUNCIÓN

Oscillating Multi-Tools Outils multifonction

LA GAMA MÁS COMPLETA PARA TODOS LOS MATERIALES

The most complete range for every material

La gamme plus complète pour tous les matériaux

Para serrar, cortar, raspar, fresar y escofinar
For sawing, cutting, scraping, milling and rasping
Pour scier, couper, fraiser et gratter



COMPATIBILIDAD / Compatibility / Compatibilité

Starlock:

Bosch GOP 12-28, PMF 220 CE, PMF 250 CES

Starlock Plus:

Bosch GOP 30-28, Bosch GOP 18V-28, Bosch PMF 350 CES, Fein AFMT 12 SL, Fein AFMT 12 QSL, Fein AFMM 18 QSL, Fein FMT 250 SL, Fein FMT 250 QSL, Fein FMM 350 QSL, Fein Multimaster, Fein Multitalent

Starlock Max:

Bosch GOP 55-36, Fein AFSC 18 QSL, Fein AFSC 18 QC SL, Fein FSC 500 QSL

OTROS Others Autres:

Bosch GOP, Bosch PMF, Fein Multimaster, Fein Multitalent, Makita, Hitachi, Metabo, Milwaukee, AEG, Einheil, Ryobi, Skil...

STARLOCK



MADERA
Wood
Bois



METAL



ESPECIAL
Special
Spécial

OSCILANTES MULTI-FUNCIÓN

Oscillating Multi-Tools
Outils multifonction

Ref. **2940**

MADERA Wood Bois



STARLOCK



Mod **00010**

CORTE CURVO MADERAS BLANDAS

Curve Cutting in Soft Wood
Coupe courbe pour bois tendre

Mod.		Nº Art.	€
00010	1	69095	20,47

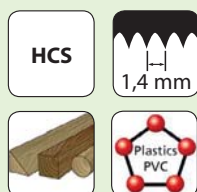
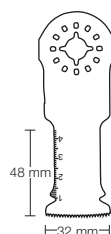

Corte limpio y preciso en maderas blandas y plásticos. Filos de corte redondeados para evitar sacudidas y conseguir una profundización suave del corte. Serrado cerca de bordes, en esquinas y zonas de difícil acceso, como p.e. ventanas estrechas para montar rejillas de ventilación.

Clean and precise cuts in softwood and plastics. Rounded cutting edges for jolt-free and smooth plunge cutting. Sawing near edges and difficult-to-reach areas, such as tight windows to install grilles.

Coupe propre et précise sur bois tendres et plastiques. Filets de coupe arrondis pour éviter les secouées et obtenir une profondeur de la coupe. Serrage près des bords, en coins et zones d'accès difficile, comme fenêtres étroites pour installer des grilles de ventilation.



Mod **00020**

CORTE CURVO MADERAS DURAS

Curve Cutting in Hard Wood
Coupe courbe pour bois dur

Mod.		Nº Art.	€
00020	1	69096	20,47

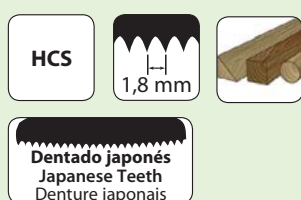
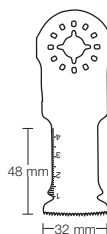

Corte limpio y preciso en maderas, sobre todo duras. Filos de corte redondeados para evitar sacudidas y conseguir una profundización suave del corte.

Clean and precise cuts in Wood, specially in hard wood. Rounded cutting edges for jolt-free and smooth plunge cutting.

Coupe propre et précise sur bois, surtout durs. Filets de coupe arrondis pour éviter les secouées et obtenir une profondeur plus douce de la coupe.



Mod **00030**

CORTE CURVO ALTO RENDIMIENTO MADERAS DURAS

High Performance Curve Cutting in Hard Wood

Coupe courbe haut rendement pour bois dur

Mod.		N°	Art.	€
00030	1	69097		25,42

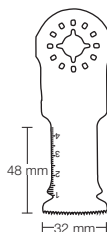

Bimetal 1,8 mm

Dentado japonés
Japanese Teeth
Denture japonais

Corte limpio y preciso en maderas, sobre todo duras. Filos de corte redondeados para evitar sacudidas y conseguir una profundización suave del corte.

Clean and precise cuts in Wood, specially in hard wood. Rounded cutting edges for jolt-free and smooth plunge cutting.

Coupe propre et précise sur bois, surtout durs. Filets de coupe arrondis pour éviter les secouées et obtenir une profondeur plus douce de la coupe.



Mod **00040**

CORTE CURVO MADERAS BLANDAS

Curve Cutting in Soft Wood

Coupe courbe pour bois tendre

Mod.		N°	Art.	€
00040	1	69099		23,60

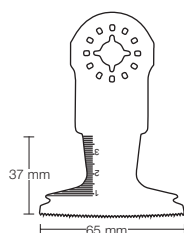

HCS 1,3 mm

Plastics
PVC

Corte limpio y preciso en maderas blandas y plásticos. Filos de corte redondeados para evitar sacudidas y conseguir una profundización suave del corte.

Clean and precise cuts in softwood and plastics. Rounded cutting edges for jolt-free and smooth plunge cutting.

Coupe propre et précise sur bois, surtout durs. Filets de coupe arrondis pour éviter les secouées et obtenir une profondeur plus douce de la coupe.



Mod **00050**

CORTE CURVO MADERAS DURAS

Curve Cutting in Hard Wood

Coupe courbe pour bois dur

Mod.		N° Art.	€
00050	1	69102	24,03

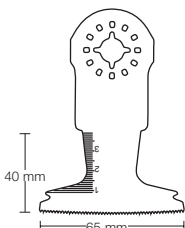

HCS	1,8 mm
	Dentado japonés Japanese Teeth Denture japonais

Corte limpio y preciso en maderas, sobre todo duras. Filos de corte redondeados para evitar sacudidas y conseguir una profundización suave del corte.

Clean and precise cuts in Wood, specially in hard wood. Rounded cutting edges for jolt-free and smooth plunge cutting.

Coupe propre et précise sur bois, surtout durs. Filets de coupe arrondis pour éviter les secouées et obtenir une profondeur plus douce de la coupe.



Mod **00060**

CORTE CURVO ALTO RENDIMIENTO MADERAS DURAS

High Performance Curve Cutting in Hard Wood

Coupe courbe haut rendement pour bois dur

Mod.		N° Art.	€
00060	1	69103	29,35

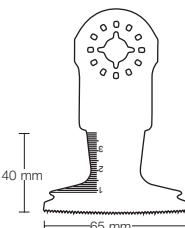

Bimetal	1,8 mm
	Dentado japonés Japanese Teeth Denture japonais

Corte limpio y preciso en maderas, sobre todo duras. Filos de corte redondeados para evitar sacudidas y conseguir una profundización suave del corte.

Clean and precise cuts in Wood, specially in hard wood. Rounded cutting edges for jolt-free and smooth plunge cutting.

Coupe propre et précise sur bois, surtout durs. Filets de coupe arrondis pour éviter les secouées et obtenir une profondeur plus douce de la coupe.

Mod **00070****HOJA SIERRA SEGMENTADA**

Segmented Saw Blade

Lame segmenté

Mod.		N°	Art.	€
00070	1	69104	23,68	

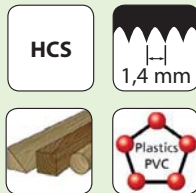
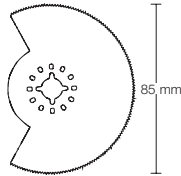

Corte limpio y preciso en maderas y plásticos. Tronzado de tubos de plástico, rejillas de ventilación, espigas salientes en uniones de madera. Recorte de molduras o marcos de puerta ya instalados; cortes de inmersión para ajustar tarimas.

Clean and precise cutting of wood and plastic. Parting of plastic pipes, grilles, protrusions in wood-unions. Installed (door) frames cutting; wood flooring plunge cutting.

Coupe propre et précise sur bois et plastiques. Tronçage sur tube en plastiques, grilles de ventilation, chevilles d'union en bois. Coupure des cadres de portes déjà installés, coupes d'immersion pour fixer les parquets.







Mod **00010**

ALTO RENDIMIENTO INOX / CLAVOS

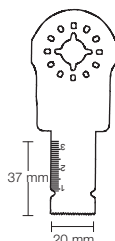
Heavy Duty Stainless / Nails
Haut rendement Inox / Clous

Mod.		N°	Art.	€
00010	1	69105		32,81



MD HM Carbure	 1,1 mm	
 Inox Stainless		 Fibra Vidrio Fibreglass

Corte limpio y preciso en metal, inoxidable, tornillos, clavos, fibra vidrio, abrasivos, pladur, barras de hierro, tubos negros, grapas.

Clean and precise cuts in metal, stainless Steel, hardened screws, nails, fibreglass, abrasives, drywall, iron bars, black pipes, staples.

Coupe propre et précise sur aciers, Inox, vis, clous, fibre de verre, abrasifs, barreaux de fer, tubes noirs et agrafes.





Mod **00020**

ALTO RENDIMIENTO INOX / CLAVOS

Heavy Duty Stainless / Nails
Haut rendement Inox / Clous

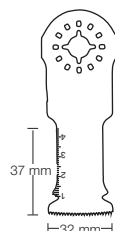
Mod.		N°	Art.	€
00020	1	69106		40,62



MD HM Carbure	 1,1 mm	
 Inox Stainless		 Fibra Vidrio Fibreglass

Corte limpio y preciso en metal, inoxidable, tornillos, clavos, fibra vidrio, abrasivos, pladur, barras de hierro, tubos negros, grapas.

Clean and precise cuts in metal, stainless Steel, hardened screws, nails, fibreglass, abrasives, drywall, iron bars, black pipes, staples.

Coupe propre et précise sur aciers, Inox, vis, clous, fibre de verre, abrasifs, barreaux de fer, tubes noirs et agrafes.







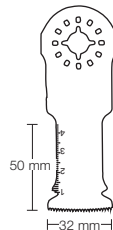

Mod **00060**

CORTE CURVO Y RÁPIDO METAL / MADERA / CLAVOS

Curve & Fast Cutting in Metal / Wood / Nails
Coupe courbe et rapide dans Métal / Bois / Clous

Mod.		Nº Art.	€
00060	1	69111	25,42



Bimetal	 1,3 mm		
 Plastics PVC		 Cu, Ni, Ms, Zn	

Corte limpio y preciso en metal, madera, maderas con clavos, plásticos y materiales no ferrosos. Filos de corte redondeados para evitar sacudidas y conseguir una profundización suave del corte.

Clean and precise cuts in metal, wood, wood with nails, plastics and non-ferrous materials. Rounded cutting edges for jolt-free and smooth plunge cutting.

Coupe propre et précise sur aciers, bois, bois avec clous, plastiques et aciers non ferreux. Filets de coupe arrondis pour éviter des secouées et obtenir une profondeur plus douce de la coupe.







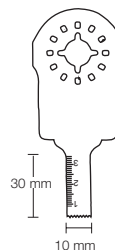

Mod **00030**

CORTE RECTO METAL / MADERA

Straight Cut Metal / Wood
Coupe droite Métal / Bois

Mod.		Nº Art.	€
00030	1	69107	14,71



Bimetal	 1,3 mm		
 Plastics PVC		 Cu, Ni, Ms, Zn	

Corte limpio y preciso en metal, madera y plásticos, metales no ferrosos, cerraduras, pladur. Aberturas para cajas de enchufe, separación de tubos de cobre a ras de superficie, cortes de inmersión en paneles de cartón enyesado.

Clean and precise cuts in metal, Wood and plastics, non-ferrous metals, locks, drywall. Opening of socket-boxes, separating copper pipes at surface level, plunge cutting in plastered carton-panels.

Coupe propre et précise sur aciers, bois et plastiques, aciers non ferreux, serrures. Ouvertures pour prises, séparation de tubes en cuivres à ras de sol, coupe d'immersion sur panneaux en plâtre.



Mod **00040**

CORTE RECTO METAL / MADERA

Straight cutting of Metal / Wood

Coupe droit Métal / Bois

Mod.		N° Art.	€
00040	1	69108	15,49

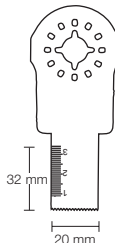

Bimetal	1,3 mm	

Corte limpio y preciso en metal, madera, plásticos y materiales no ferrosos, pladur, clavos, tubos a ras de superficie.

Clean and precise cuts in metal, Wood, plastics and non-ferrous materials, drywall, nails, pipes at the level of the surface.

Coupe propre et précise sur aciers, bois, plastiques et aciers non ferreux, clous, tubes à ras de sol.



Mod **00050**

CORTE RECTO METAL / MADERA

Straight cutting of Metal / Wood

Coupe droit Métal / Bois

Mod.		N° Art.	€
00050	1	69109	22,16

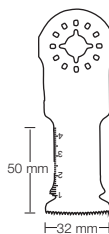

Bimetal	1,3 mm	

Corte limpio y preciso en metal, madera, plásticos y materiales no ferrosos, pladur.

Clean and precise cuts in metal, Wood, plastics and non-ferrous materials, drywall.

Coupe propre et précise sur aciers, bois, plastiques et aciers non ferreux, plâtre.



Mod **00070**

CORTE CURVO Y RÁPIDO METAL / MADERA / CLAVOS

Curve & Fast Cutting in Metal / Wood / Nails
Coupe courbe et rapide dans Métal / Bois / Clous

Mod.		N° Art.	€
00070	1	69112	31,23

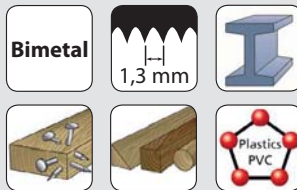
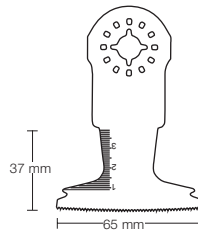

Corte limpio y preciso en metal, madera, maderas con clavos y plásticos. Filos de corte redondeados para evitar sacudidas y conseguir una profundización suave del corte.

Clean and precise cuts in metal, wood, wood with nails and plastics. Rounded cutting edges for jolt-free and smooth plunge cutting.

Coupe propre et précise sur aciers, bois, bois avec clous et plastiques. Filets de coupe arrondis pour éviter des secouées et obtenir une profondeur plus douce de la coupe.



Mod **00080**

SIERRA SEGMENTADA. CORTE FINO METAL / MADERA

Segmented Blade. Fine cutting of Metal / Wood
Lame segmenté. Coupe fin dans Métal / Bois

Mod.		N° Art.	€
00080	1	69113	30,72

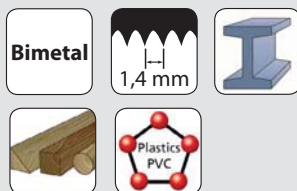
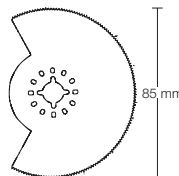

Corte limpio y preciso en metal, madera y plásticos. Recorte de marcos de puertas a ras de suelo, laminados, parquet, listones para perfiles.

Clean and precise cuts in metal, wood, wood with nails and plastics. Door-frame trimming at the level of the floor, laminated, parquet, profile-strips.

Coupe propre et précise sur aciers, bois, bois avec clous et plastiques. Filets de coupe arrondis pour éviter des secouées et obtenir une profondeur plus douce de la coupe.



Mod 00090

SIERRA SEGMENTADA. ALTO RENDIMIENTO METAL / MADERASegmented Blade. High performance in Metal / Wood
Lame segmenté. haut rendement dans Métal / Bois

Mod.	N° Art.	€
00090	1 69114	42,02

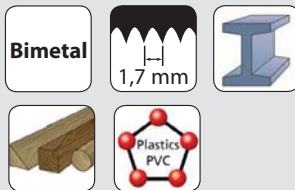
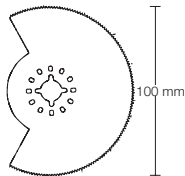
**Corte limpio y preciso en metal, madera y plásticos. Recorte de marcos de puertas a ras de suelo, laminados, parqueté, listones para perfiles.**

Clean and precise cuts in metal, wood, wood with nails and plastics. Door-frame trimming at the level of the floor, laminated, parquet, profile-strips.

Coupe propre et précise sur aciers, bois et plastiques. Coupures de cadres de portes à ras de sol, laminés, parquets et profils.



Mod 00100

CORTE CURVO MADERAS BLANDASCurve Cutting in Soft Wood
Coupe courbe pour bois tendre

Mod.	N° Art.	€
00100	1 69115	43,68

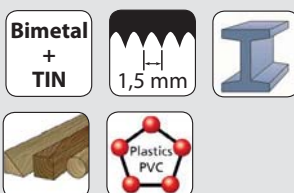
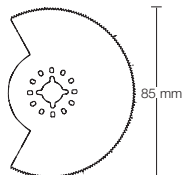
**Corte limpio y preciso en metal, madera y plásticos. Dientes recubiertos en titanio para una mayor vida de la herramienta. Corte de entalladuras en epoxy, GFK, listones pequeños para perfiles.**

Clean and precise cuts in metal, wood, wood with nails and plastics. Titanium coated teeth for a longer lifetime. Cutting of epoxy-joinings, GFK, small profile-strips.

Coupe propre et précise sur aciers, bois et plastiques. Dents recouvertes en titane pour une plus longue vie de l'outil. Coupure dans les bords, petites barres pour profils.



Mod **00010**

PLACA LIJADORA

Sanding Plate
Patin de ponçage

Mod.		Nº	Art.	€
00010	1	69116		21,30

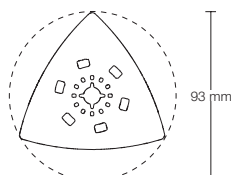

Placa para pulir con fijación tipo micro-velcro.
Sanding plate with micro-velcro type fastening.
Patin de ponçage avec aspiration des poussières.



Mod **00020**

PLACA LIJADORA DESBASTE

Sanding Plate for Roughing
Patin de ponçage ébauche

Mod.		Nº	Art.	€
00020	1	69117		40,35

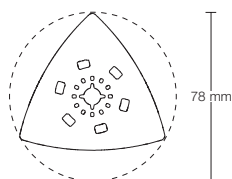

MD/HM Carbure K20	
	Grueso Coarse Gross



Ideal para eliminar mortero, adhesivo de azulejos y residuos de adhesivos en alfombras, incluso en esquinas gracias a su forma triangular.

Ideal for removing mortar, tile adhesive and carpet adhesive residues even in the corners with the triangle shape.

Conseillé pour supprimer le mortier, colle de carrelage et copeaux collants sur tapis, même aux corners grâce à sa forme triangulaire.

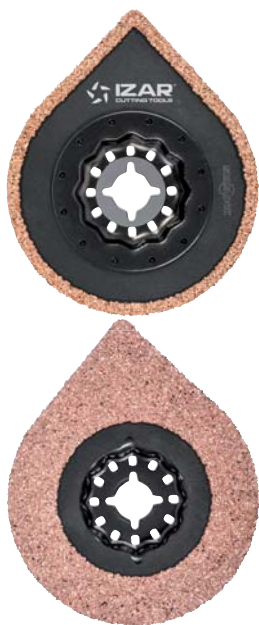

Mod **00030**

SIERRA SEGMENTADA + PLACA LIJADORA

Segmented Saw + Sanding Plate

Lame segmenté à concretion carbure plus patin de ponçage

Mod.		N° Art.	€
00030	1	69118	69,02

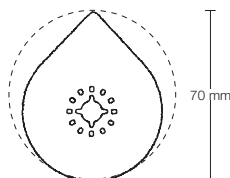

MD/HM Carbure K40	 2 mm
 Medium	 Medium



Ideal para eliminar grout y mortero de juntas de paredes y suelos, incluso en las esquinas más remotas.

Ideal for removing grout & mortar from Wall and floor tiles, even in the most remote corners.

Conseillé pour supprimer mortier sur joints de murs et sols, même sur les corners plus difficiles.



Mod **00060**

SIERRA INMERSIÓN ABRASIVOS

Plunge Saw for Abrasives

Lame immersion abrasifs

Mod.		N° Art.	€
00060	1	69121	41,30

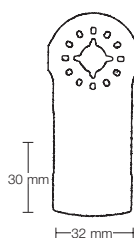

MD/HM Carbure K50	 2 mm	 Fibra Vidrio Fibreglass
 Medium	 Medium	

Corte profundo en materiales muy abrasivos como la fibra de vidrio. Filos de corte redondeados para evitar sacudidas y conseguir una profundización suave del corte.

Plunge cutting in strongly abrasive materials, such as fibreglass. Rounded cutting edges for jolt-free and smooth plunge cutting.

Coupe profonde sur matériaux abrasifs comme la fibre de verre. Filets de coupe arrondis pour éviter les secouées et obtenir une profondeur douce de la coupe.





Mod **00040**

SIERRA INMERSIÓN LIJADO FINO

Plunge Saw for Fine Sanding

Râpe à concretion carbure

Mod.		N° Art.	€
00040	1	69119	38,16

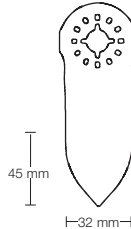

MD/HM
Carbure
K100



Pulido de residuos de pintura, madera, plásticos, composites, epoxy. Ranurado en espacios estrechos y áreas remotas. Usar a 2/3 de la velocidad máxima. Lijado de madera o pintura en zonas de difícil acceso sin papel de lijar.

Sanding of Paint residues, Wood, plastic, composite, epoxy. Slotting in tight gaps and hard-to-reach areas. Use 2/3 of maximum speed. Sanding of wood or painting in difficult-to-reach areas without sanding-paper.

Dégrossissage de residus de peinture, bois, plastiques et composites. Rainurage sur endroits exigus et zones difficiles. Utilisez à 2/3 de la vitesse maximale. Ponçage de peinture où bois sur zones de difficile accès sans papier de ponçage.



Mod **00050**

SIERRA INMERSIÓN LIJADO DESBASTE

Plunge Saw for Rough Sanding

Râpe à concretion carbure ébauche

Mod.		N° Art.	€
00050	1	69120	38,16

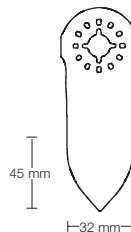

MD/HM
Carbure
K40



Pulido de residuos de pintura, madera, plásticos, composites, epoxy. Ranurado en espacios estrechos y áreas remotas. Usar a 2/3 de la velocidad máxima.

Sanding of Paint residues, Wood, plastic, composite, epoxy. Slotting in tight gaps and hard-to-reach areas. Use 2/3 of maximum speed.

Dégrossissage de residus de peinture, bois, plastiques et composites. Rainurage sur endroits exigus et zones difficiles. Utilisez à 2/3 de la vitesse maximale.



Mod **00070**



CORTE GRUESO ENTRE AZULEJOS

Rough Cutting among Tiles

Coupe grosse carreaux

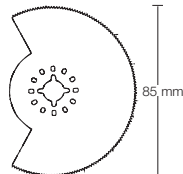
Mod.		N° Art.	€
00070	1	69122	45,00



MD/HM Carbure K30	2 mm 	 Fibra Vidrio Fibreglass
	Grueso Coarse Gross	

Alineado de juntas en azulejos de pared y suelo.

Precise routing joints on wall and floor tiles.

Pour aligner les joints sur carreaux murs et sols.



Mod **00080**



CORTE FINO ENTRE AZULEJOS

Fine Cutting among Tiles

Coupe fine carreaux

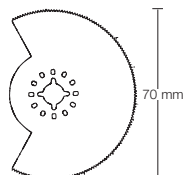
Mod.		N° Art.	€
00080	1	69123	38,41



MD/HM Carbure K40	1,4 mm 	 Plastics PVC
	Medium	

Alineado de juntas en azulejos de pared y suelo.

Precise routing joints on wall and floor tiles.

Pour aligner les joints sur carreaux murs et sols.



Mod **00090**

CORTE DIAMANTE AZULEJOS EXTERIOR

Diamond Cutting of Outer Tiles
Coupe diamant carreaux extérieur

Mod.		Nº	Art.	€
00090	1	69124		77,09

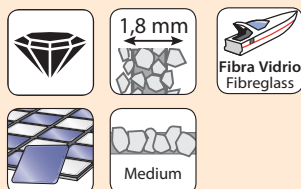
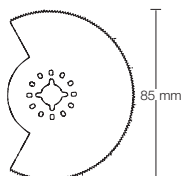

Alineado de juntas en azulejos de pared y suelo. Separación de azulejos, resinas epoxi y plásticos reforzados con fibra de vidrio.

Precise routing joints on wall and floor tiles. Separating of tiles, epoxi gum and fibreglass reinforced plastics.

Pour aligner les joints sur carreaux murs et sols. Séparation de carreaux, résines et plastiques renforcées avec fibre de verre.



Mod **00100**

DENTADO ONDULADO AISLANTES

Waved Teeth for Isolating
Denture vague isolation

Mod.		Nº	Art.	€
00100	1	69126		43,21

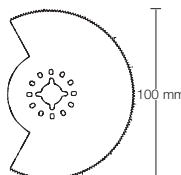

Ideal para materiales de aislamiento como el poliestireno, espuma rígida, materiales blandos como alfombras, caucho, cuero... Cortes a ras de suelo de material sobresaliente.

Ideal for isolating materials, such as polystyrene, rigid foam, soft materials such as carpets, rubber, leather... Cutting of protruding material at floor level...

Conseillé pour matériaux isolation comme le polystyrène, mousse rigide, matériaux tendres comme tapis, cuire... Coupe à ras de sol des matériaux dépassants

Mod **00110****RASCADORA**Scraper
Racloir

Mod.		N°	Art.	€
00110	1	69127	14,92	

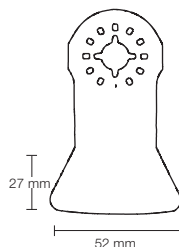
**HCS**

Restos blandos de pegamento, moqueta, material aglutinante, material de juntas, silicona...
Soft remains of glue, carpet, agglutinative material, joint-material, silicone...
Copeaux tendres de colle, tapis, matière agglutinantes, matériel de jointes, ...

Mod **00120****DENTADO ONDULADO AISLANTES**Waved Teeth for Isolating
Denture vague isolation

Mod.		N°	Art.	€
00120	1	69129	26,84	

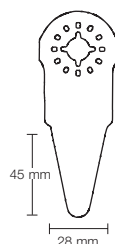
**HCS**

Abrasivos

Juntas de expansión blanda y materiales de aislamiento, silicona en ventanas.
Soft expanding joints and insulating materials, silicone in windows.
Jointes d'expansion tendres et matériaux. silicones en fenêtres.



Mod **00130**

CORTE PRECISO MATERIALES BLANDOS Y ABRASIVOS

Precise Cutting of Soft Materials and Abrasives
Coupe précis de matériaux moelleux et abrasifs

Mod.		Nº Art.	€
00130	1	69130	32,83

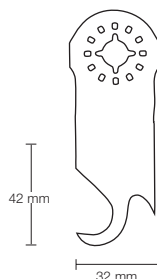

Corte rápido y preciso de material blando y material flexible abrasivo, p.e. alfombras, cartón, PVC...

Fast and precise cutting of soft material and abrasive flexible material, such as carpets, carton, PVC...

Coupe propre et précise sur bois tendres et matériaux flexibles abrasifs. Tapis, cartons, PVC.



SETS

Ref. **2900**

SETS MULTI-FUNCIÓN

Oscillating Multi-Tool Sets
Jeux de outils multifonction

Ref. **2940-2910**

Ref. **2930**

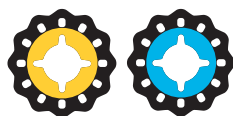

MADERA
Wood Bois
+ METAL

4 Pcs

Cont.	Nº Art.	€
Ref. 2940: Mod. 00030	69702	122,68
Ref. 2910: Mods. 00020-00060-00070		



ESPECIAL
Special
Spécial

4 Pcs

Cont.	Nº Art.	€
Ref. 2930: Mods. 00020-00060-00070-00080	69704	165,06



Línea 1m
2900

OSCILANTES MULTI-FUNCIÓN

Oscillating Multi-Tools
Outils multifonction



25 cm

Ref.	2910	2910	2910	2910	2930	2930	2940	2940	2940
	00030	00050	00070	00080	00080	00110	00020	00030	00070
Pcs	3	3	3	3	3	3	3	3	3

Ref. 4995 - Nº Art. 72189: 665,19 €

Display
53

OSCILANTES MULTI-FUNCIÓN

Oscillating Multi-Tools
Outils multifonction



Ref. 2940			
ø	Mod. 00020	Mod. 00030	Mod. 00070
Pcs	3	3	3
Ref. 2910			
ø	Mod. 00030	Mod. 00050	Mod. 00070
Pcs	3	3	3
Ref. 2910		Ref. 2930	
ø	Mod. 00080	Mod. 00080	Mod. 00110
Pcs	3	3	3

Ref. 4995 - Nº Art. 69451: 665,19 €



Mod **00010**

CORTE RECTO MADERAS BLANDAS

Soft Wood Straight Cutting
Coupe droite bois tendre

Mod.		Nº Art.	€ Pack
00010	5	69140	55,79

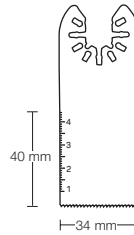

QUICK-FIT

HCS

Plastics PVC



Dentado estándar. Corte en madera y plástico.

Standard teeth for wood and plastics.

Denture estándar. Coupe en bois et plastique.



Mod **00020**

CORTE RECTO MADERAS DURAS

Hard Wood Straight Cutting
Coupe droite bois dur

Mod.		Nº Art.	€ Pack
00020	5	69141	80,94

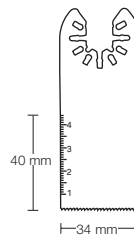

QUICK-FIT

Bimetal

Plastics PVC



Dentado ondulado universal. Corte en madera, plástico, pladur, metal y madera con clavos.

Universal wave teeth for wood, plastics, drywall, metal and wood with nails.

Denture vague universelle. Coupe en bois, plastique, plâtre, métal et bois avec clous.



Mod **00030**

CORTE RECTO ALTO RENDIMIENTO MADERAS DURAS

Hard Wood High Performance Straight Cutting
Coupe droite haut rendement bois dur

Mod.		Nº Art.	€ Pack
00030	5	69142	57,64

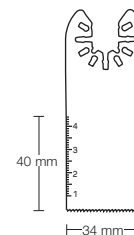

QUICK-FIT

Bimetal

Plastics PVC



Dentado japonés para corte en madera, contrachapado, plástico y otros materiales blandos.

Japanese teeth for wood, plywood, plastics and other soft materials.

Denture japonaise pour coupe en bois, tole fine metal, plastiques et autres bois tendres.

Ref. **2950**

MULTI



QUICK-FIT



Mod **00040**

RASCADORA

Scraper
Racloir

Mod.	N° Art.	€ Pack
00040	5 69457	35,43

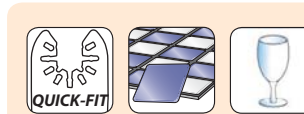
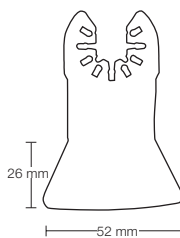

Rascador de silicona o similares en superficies lisas y delicadas como azulejos o cristal.
Removing of silicone or caulking against a flat surface such as tile or glass that can be easily scratched.
Racloir silicone où similaire pour surfaces lises et délicats comme carreaux où verre.



Ref. **2960**

MULTI



SUPERCUT



Mod **00010**

CORTE RECTO METAL / MADERA / CLAVOS

Straight Cutting in Metal / Wood / Nails
Coupe droite dans Métal / Bois / Clous

Mod.	N° Art.	€ Pack
00010	5 69143	80,94

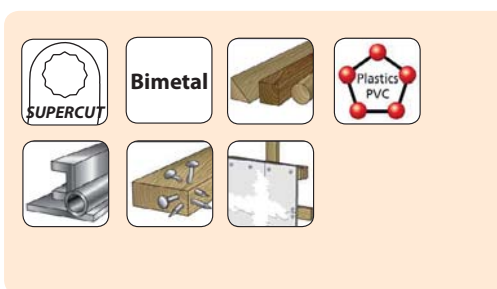
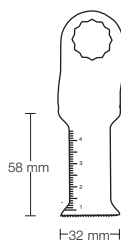

Dentado ondulado universal para madera, pladur, plástico, metal y madera con clavos. Mango acero inoxidable.
Universal wave teeth for wood, drywall, plastics, metal and wood with nails. Stainless steel holder.
Denture vague universelle pour bois, plâtre, plastique, métal et bois avec clous. Queue en acier inoxydable.



Mod **00020**

CORTE RECTO METAL / MADERA / CLAVOS

Straight Cutting in Metal / Wood / Nails
Coupe droite dans Métal / Bois / Clous

Mod.	N° Art.	€ Pack
00020	5 69144	83,75

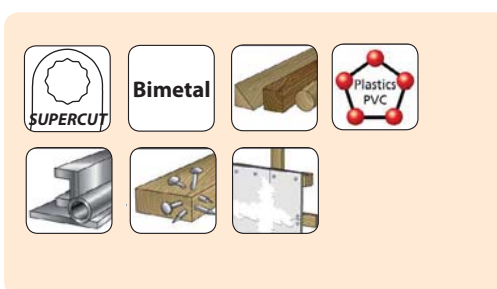
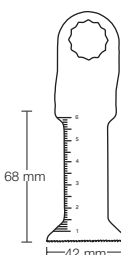

Dentado ondulado universal para madera, pladur, plástico, metal y madera con clavos. Mango acero inoxidable.
Universal wave teeth for wood, drywall, plastics, metal and wood with nails. Stainless steel holder.
Denture vague universelle pour bois, plâtre, plastique, métal et bois avec clous. Queue en acier inoxydable.



CUADRO USO SIERRAS SABLE

Sabre Blade Use Table

Tableau utilisation lames scies sabre

● Ideal ● Ideal - Idéal							MADERA Wood - Bois					PLÁSTICOS Plastics - Plastiques			METAL	
							<i>Todos tipos</i> All types Toutes sortes	<i>Dura</i> Hard Dur	<i>Pallet</i> Pallet Palette	<i>Marcos ventana</i> Window frames Fenêtres	<i>Con clavos</i> With nails Avec clous	<i>Viva</i> Green Vert	<i>Plásticos</i> Plastics Plastiques	<i>Reforzados fibra-carbon</i> Carbon fibre reinforced Renforcés fibre-carbone	<i>Plexiglass</i> Perspex	<i>INOX</i> Stainless
○ Adecuado ○ Suitable - Convenable	Ref. - Mod.	Equiv.	Mat.	TPI	l mm	Pág.										



Madera Wood - Bois	1950	00010	S1617K	HCS/CV	3	280	322	●	○					●				
		00020	S644D	HCS/CV	6	130	322	●	○					●				
		00030	S1531L	HCS/CV	4-5	220	323							●				
		00210	S2345X	HCS/CV	6	220	323	●	○					●		●		
		00220	S611VF	Bi-metal	5-8	130	324	●	○			●						
		00230	S1111VF	Bi-metal	5-8	205	324	●	○			●						

Metal Metal - Métal	1920	00020	S922EF	Bi-metal	18	130	325											●	
		00030	S922BF	Bi-metal	14	130	326												●
		00050	S1025VF	Bi-metal	10-14	180	327			●		●							
		00200	S1122EF	Bi-metal	18	180	325												●
		00210	S1122BF	Bi-metal	14	180	326												●
		00220	S922HF	Bi-metal	10	130	327												●
		00230	S1122HF	Bi-metal	10	180	328												●
		00240	S1211HF	Bi-metal	10	260	328												●
		00250		Bi-metal	10-14	130	329					●							
		00260	S123XF	Bi-metal	10-14	205	329					●							
		00280		Bi-metal	10	280	329					●							●

Especial Special	1960	00020	S922VF	Bi-metal	10-14	130	330	●	○	●		●							
		00030	S1122VF	Bi-metal	10-14	205	330	●	○	●		●							
		00040	S611DF	Bi-metal	6	130	331	●	○					●					
		00060	S1411DF	Bi-metal	6	280	331	●	○					●					
		00200	S1141HM	CV-HM	3	205	332	○	●						●				
		00210	S1241HM	CV-HM	3	280	332	○	●						●				
		00220	S1211K	INOX	4	280	334	●	○										
		00240	S1213AWP	HCS/CV		280	334												
		00260	S1243HM	CV-HM	2	305	333												
		00270	S2243HM	CV-HM	2	455	333												

SIERRAS SABLE

Sabre Saw Blades

Lames scie sabre

Ref. **1950**

MADERA Wood Bois

Mod **00010**

CORTE BASTO

Rough Cut
Coupe grosse



S1617K



Dentado alterno y afilado diagonal. Corte basto para madera en general y madera viva.

Side set and diagonally sharpened toothing. Rough cutting of wood and green wood.

Denture avoyée, dépouillée et affûtée. Coupe grosse dans différents types de bois et bois verts.

Mod.	TPI	Diente Tooth mm	Dent mm	L mm	I mm	№ Art.	€ pack
00010	3	8,5	8,5	300	280	5 18870	23,29



Mod **00020**

CORTE RÁPIDO RECTO

Straight Fast Cut
Coupe rapide droite



S644D



Dentado alterno y afilado diagonal. Corte rápido y recto en todo tipo de maderas, plásticos y pladur.

Side set and diagonally sharpened toothing. Fast and straight cutting for all wood types, plastics and drywall.

Denture avoyée, dépouillée et affûtée. Coupe rapide et droite dans différents types de bois, plastiques et plâtres.

Mod.	TPI	Diente Tooth mm	Dent mm	L mm	I mm	№ Art.	€ pack
00020	6	4,2	4,2	150	130	5 18871	15,52



Mod **00030**

MADERA VIVA

Green Wood
Bois verts



S1531L



TPI
4-5



Dentado alterno reforzado por inducción con afilado diagonal. Especial madera viva.

Side set and diagonally sharpened induction hardened toothing. Special for green wood.

Denture avoyée, dépouillée, affûtée et traitée inductivement. Spécial pour bois verts.

Mod.	TPI	Diente Tooth Dent mm	L mm	I mm		Nº Art.	€ pack
00030	4-5	6,35-5	300	280	5	18872	24,63



Mod **00210**

CORTE LIMPIO

Clean Cut
Coupe propre



S2345X

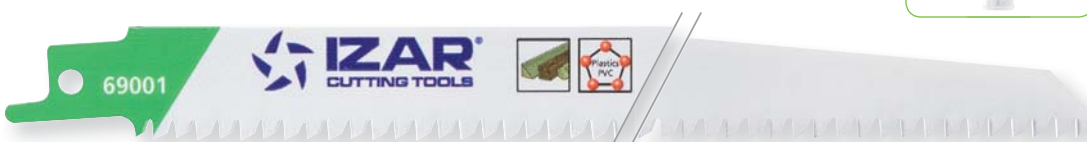

TPI
6



Dentado afilado triple. Corte limpio en todo tipo de maderas y plásticos.

Triply sharpened toothing. Clean cutting of all types of wood and plastics.

Denture triple dépouillée et affûtée. Coupe propre dans différents types de bois et plastiques.

Mod.	TPI	Diente Tooth Dent mm	L mm	I mm		Nº Art.	€ pack
00210	6	4,2	240	220	5	69001	24,84



Mod **00220**

CORTE RECTO ANCHO ESPECIAL

Special Thick Straight Cut
Coupe droite très grosse



S611VF

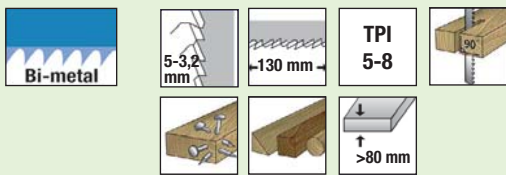

Dentado alterno y variable. Ancho de sierra especial para corte recto en todo tipo de maderas con residuos de metales.

Side set and variable tothing. Special thick blade for straight cutting of all wood types with few metal residues.

Denture fraisée, affûtée et variable. Lame très grosse pour coupe droite dans différents types de bois.

Mod.	TPI	Diente Tooth Dent mm	L mm	I mm	📦 Nº Art.	€ pack
00220	5,8	5-3,2	150	130	5 69002	23,26



Mod **00230**

CORTE RECTO LARGO ANCHO ESPECIAL

Special Thick Long Straight Cut
Coupe droite longue très grosse



S1111VF

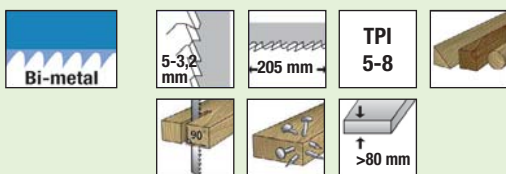
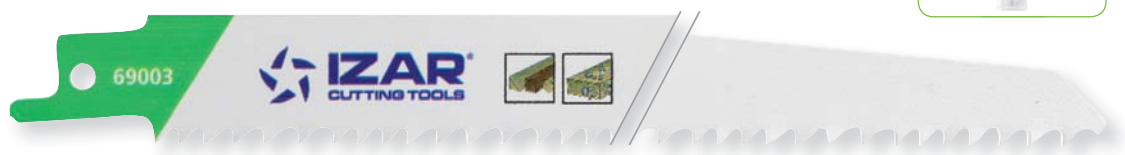

Dentado alterno y variable. Ancho de sierra especial para corte recto en todo tipo de maderas con residuos de metales.

Side set and variable tothing. Special thick blade for straight cutting of all wood types with few metal residues.

Denture fraisée, affûtée et variable. Lame très grosse pour coupe droite dans différents types de bois.

Mod.	TPI	Diente Tooth Dent mm	L mm	I mm	📦 Nº Art.	€ pack
00230	5-8	5-3,2	225	205	5 69003	31,01



Mod **00020**

UNIVERSAL CORTE FLEXIBLE

Universal Flexible Cut
Universel coupe flexible



S922EF



			TPI 18	

Dentado fresado y ondulado. Sierra flexible y universal para aceros e inoxidables.

Milled teeth and wavy set. Flexible and universal blade for steel and stainless steel.

Dents fraisés et ondulés. Lame flexible et universel pour aciers et Inox.

Mod.	TPI	Diente Tooth Dent mm	L mm	I mm		Nº Art.	€ pack
00020	18	1,4	150	130	5	18865	16,43



Mod **00200**

UNIVERSAL CORTE FLEXIBLE LARGO

Universal Long Flexible Cut
Universel coupe flexible longue



S1122EF



			TPI 18	

Dentado fresado y ondulado. Sierra flexible y universal para aceros e inoxidables.

Milled teeth and wavy set. Flexible and universal blade for steel and stainless steel.

Dents fraisés et ondulés. Lame flexible et universelle pour aciers et Inox.

Mod.	TPI	Diente Tooth Dent mm	L mm	I mm		Nº Art.	€ pack
00200	18	1,4	200	180	5	69004	25,23



Mod **00030**

CORTE ACEROS, INOX, NO FERROSOS

Steel, Stainless, Non-Ferrous Cut
Coupe Aciers, Inox, Non ferreux



S922BF



			TPI 14	

Dentado fresado y ondulado. Sierra flexible y universal para aceros, inoxidables y metales no ferrosos.

Milled teeth and wavy set. Flexible and universal blade for steel, stainless steel and non-ferrous metals.

Dents fraisés et ondulés. Lame flexible et universelle pour aciers, Inox et métaux non ferreux.

Mod.	TPI	Diente Tooth Dent mm	L mm	l mm		Nº Art.	€ pack
00030	14	1,8	150	130	5	18866	18,25



Mod **00210**

CORTE LARGO ACEROS, INOX, NO FERROSOS

Steel, Stainless, Non-Ferrous Long Cut
Coupe longue Aciers, Inox, Non ferreux



S1122BF



			TPI 14	

Dentado fresado y ondulado. Sierra flexible y universal para aceros, inoxidables y metales no ferrosos.

Milled teeth and wavy set. Flexible and universal blade for steel, stainless steel and non-ferrous metals.

Dents fraisés et ondulés. Lame flexible et universelle pour aciers, Inox et métaux non ferreux.

Mod.	TPI	Diente Tooth Dent mm	L mm	l mm		Nº Art.	€ pack
00210	14	1,8	200	180	5	69005	24,03



Mod **00050**

CORTE RECTO ANCHO ESPECIAL PALLETS

Pallet Special Thick Straight Cut
Coupe droite très grosse palettes



S1025VF



Bi-metal

2,5-1,8 mm

180 mm

TPI 10-14

>2,5 mm

Dentado fresado, ondulado y variable. Ancho de sierra especial para corte recto en todo tipo de maderas con residuos de metales. Especial reparación de pallets.

Side set, wavy and variable toothing. Special thick blade for straight cutting of all wood types with few metal residues. Special for pallet repair.

Denture ondulé et variable. Lame très grosse pour coupe droite dans différents types de bois. Spécial pour réparation de palettes.

Mod.	TPI	Diente Tooth Dent mm	L mm	I mm	📦	Nº Art.	€ pack
00050	10-14	2,5-1,8	200	180	5	18868	27,75



Mod **00220**

CORTE ACEROS, INOX, NO FERROSOS

Steel, Stainless, Non-Ferrous Cut
Coupe Aciers, Inox, Non ferreux



S922HF



Bi-metal

2,5 mm

130 mm

TPI 10

INOX STAINLESS

Cu, Ni, Mn, Zn

3-12 mm

Dentado fresado y ondulado. Sierra flexible y universal para aceros, inoxidables y metales no ferrosos.

Milled teeth and wavy set. Flexible and universal blade for steel, stainless steel and non-ferrous metals.

Dents fraisés et ondulés. Lame flexible et universelle pour aciers, Inox et métaux non ferreux.

Mod.	TPI	Diente Tooth Dent mm	L mm	I mm	📦	Nº Art.	€ pack
00220	10	2,5	150	130	5	69006	19,24



Mod **00230**

CORTE LARGO ACEROS, INOX, NO FERROSOS

Steel, Stainless, Non-Ferrous Long Cut
Coupe Longue Aciers, Inox, Non ferreux



S1122HF

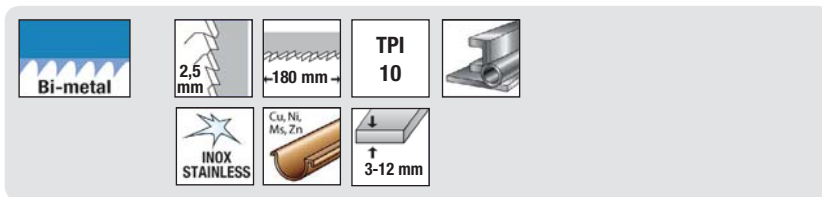
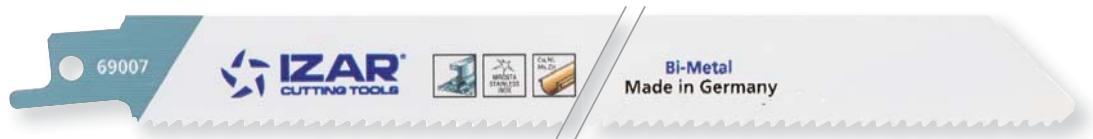

Dentado fresado y ondulado. Sierra flexible y universal para aceros, inoxidable y metales no ferrosos.

Milled teeth and wavy set. Flexible and universal blade for steel, stainless steel and non-ferrous metals.

Dents fraisés et ondulés. Lame flexible et universelle pour aciers, Inox et métaux non ferreux.

Mod.	TPI	Diente Tooth mm	Dent mm	L mm	I mm	Nº Art.	€ pack
00230	10	2,5	2,5	200	180	5 69007	22,89



Mod **00240**

CORTE ACEROS, INOX, NO FERROSOS

Steel, Stainless, Non-Ferrous Cut
Coupe Aciers, Inox, Non ferreux



S1211HF

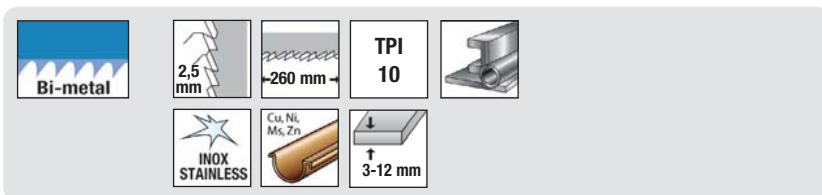

Dentado fresado y ondulado. Sierra flexible y universal para aceros, inoxidable y metales no ferrosos.

Milled teeth and wavy set. Flexible and universal blade for steel, stainless steel and non-ferrous metals.

Dents fraisés et ondulés. Lame flexible et universelle pour aciers, Inox et métaux non ferreux.

Mod.	TPI	Diente Tooth mm	Dent mm	L mm	I mm	Nº Art.	€ pack
00240	10	2,5	2,5	280	260	5 69008	28,09



Mod **00260**

CORTE FLEXIBLE LARGO ALTO RENDIMIENTO

Long Life Long Flexible Cut
Coupe flexible longue longue durée



S123XF

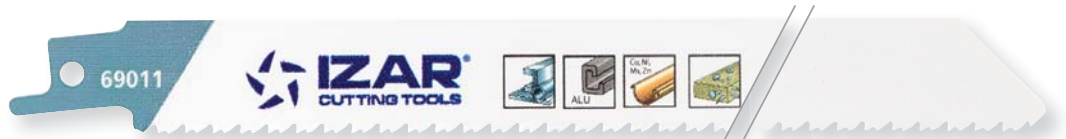

Bi-metal

2,5-1,8 mm

205 mm

TPI 10-14

Cu, Ni, Ms, Zn

ALU

>2,5 mm

Dentado fresado y ondulado con geometría especial. Sierra flexible de alto rendimiento en metal y madera con residuos de metal.

Special geometry milled teeth and wavy set. High performance flexible blade for steel and wood with metal residues.

Dents fraisés et ondulés avec géométrie spéciale. Lame flexible, haut rendement dans aciers et bois.

Mod.	TPI	Diente Tooth Dent mm	L mm	I mm	3D	Nº Art.	€ pack
00260	10-14	2,5-1,8	225	205	5	69011	28,64



Mod **00280**

RESCATE Y DESMONTAJE CORTE LARGO

Long Cut Rescue & Dismantling
Secours et démontage coupe longue



Bi-metal

2,5 mm

280 mm

TPI 10

INOX STAINLESS

90°

>3 mm

Dentado fresado y alterno. Sierra robusta con ancho especial para corte recto y rápido en acero, todo tipo de maderas con residuos de metal. Especial rescate y desmontaje.

Milled and side set teeth. Special thick and robust blade for fast and straight cutting of steel and all types of wood with metal residues. Especial for rescue and dismantling.

Dents fraisés et ondulés. Lame très épaisse pour coupe droite et rapide dans aciers et différents types de bois. Spéciale pour secours et démontages.

Mod.	TPI	Diente Tooth Dent mm	L mm	I mm	3D	Nº Art.	€ pack
00280	10	2,5	300	280	5	69014	58,85



Mod **00020**

REPARACIÓN PALLETS

Pallet Repair
Réparation de palettes



S922VF

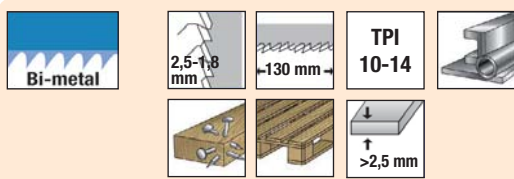

Dentado fresado, ondulado y variable. Todo tipo de maderas con residuos de metales. Especial reparación de pallets.

Side set, wavy and variable toothing. All wood types with metal residues. Special for pallet repair.

Denture fraisée, ondulé et variable. Différents types de bois. Spéciale pour réparation de palettes.

Mod.	TPI	Diente Tooth Dent mm	L mm	I mm	№ Art.	€ pack
00020	10-14	2,5-1,8	150	130	5 18874	20,04



Mod **00030**

REPARACIÓN PALLETS CORTE LARGO

Long Cut Pallet Repair
Réparation de palettes coupe longue



S1122VF

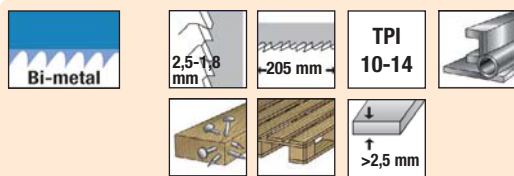

Dentado fresado, ondulado y variable. Todo tipo de maderas con residuos de metales. Especial reparación de pallets.

Side set, wavy and variable toothing. All wood types with metal residues. Special for pallet repair.

Denture fraisée, ondulé et variable. Différents types de bois. Spéciale pour réparation de palettes.

Mod.	TPI	Diente Tooth Dent mm	L mm	I mm	№ Art.	€ pack
00030	10-14	2,5-1,8	225	205	5 18875	24,98



Mod **00040**

CORTE FLEXIBLE RECTO RÁPIDO ALTO RENDIMIENTO

Long Life Fast Straight Flexible Cut
Coupe flexible droite rapide longue durée



Bi-metal 4,2 mm 130 mm TPI 6 90° Plastics PVC

S611DF



Dentado fresado y alterno. Sierra flexible para corte recto y rápido en todo tipo de maderas y plásticos. Alto rendimiento.

Side set, milled teeth. Flexible blade for fast and straight cutting of all types of woods and plastics. Long lifetime.
Denture fraisée et avoyée. Lame flexible pour coupe droite et rapide dans différents types de bois et plastiques. Durée de vie plus longue.

Mod.	TPI	Diente Tooth Dent mm	L mm	I mm	№ Art.	€ pack
00040	6	4,2	150	130	5 18876	19,74

Mod **00060**

CORTE EXTRA LARGO FLEXIBLE RECTO RÁPIDO ALTO RENDIMIENTO

Long Life Fast Straight Flexible Extra Long Cut
Coupe extra longue flexible droite rapide longue durée



Bi-metal 4,2 mm 280 mm TPI 6 90° Plastics PVC

S1411DF

Dentado fresado y alterno. Sierra flexible para corte recto y rápido en todo tipo de maderas y plásticos. Alto rendimiento.

Side set, milled teeth. Flexible blade for fast and straight cutting of all types of woods and plastics. Long lifetime.
Denture fraisée et avoyée. Lame flexible pour coupe droite et rapide dans différents types de bois et plastiques. Durée de vie plus longue.

Mod.	TPI	Diente Tooth Dent mm	L mm	I mm	№ Art.	€ pack
00060	6	4,2	300	280	5 18878	32,50



Mod **00200**

DENTADO TUNGSTENO

Tungsten Teeth
Denture Tungstène



S1141HM

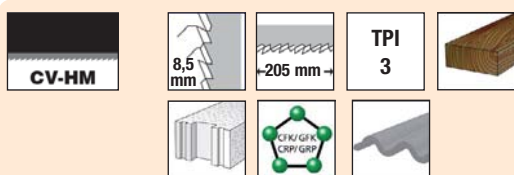

Dentado de tungsteno. Especial madera dura, hormigón poroso y productos reforzados con fibra de vidrio.

Side set, milled teeth. Special for hard wood, gas-formed concrete and glass-fibre reinforced products.

Denture fraisée et avoyée. Spéciale pour bois durs, bétons et matières plastiques renforcées avec fibres de verre.

Mod.	TPI	Diente Tooth Dent mm	L mm	I mm		Nº Art.	€ pack
00200	3	8,5	225	205	1	69017	39,25



Mod **00210**

DENTADO TUNGSTENO CORTE LARGO

Long Cut Tungsten Teeth
Denture Tungstène coupe longue



S1241HM

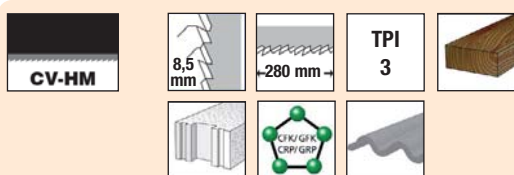

Dentado de tungsteno. Especial madera dura, hormigón poroso y productos reforzados con fibra de vidrio.

Side set, milled teeth. Special for hard wood, gas-formed concrete and glass-fibre reinforced products.

Denture fraisée et avoyée. Spéciale pour bois durs, bétons et matières plastiques renforcées avec fibres de verre.

Mod.	TPI	Diente Tooth Dent mm	L mm	I mm		Nº Art.	€ pack
00210	3	8,5	300	280	1	69019	45,72



Mod **00260**

DEMOLICIÓN CORTE LARGO TCT

TCT Long Cut Demolition
Démolition coupe longue TCT



S1243HM

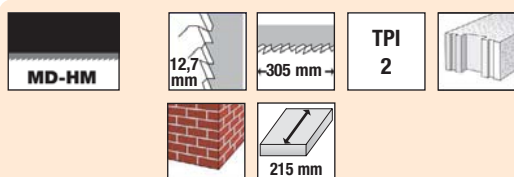

Dentado de tungsteno. Especial bloques de hormigón poroso, ladrillo, fibrocemento.

Tungsten teeth. Special for aerated concrete blocks, brick, fibre cement.

Denture Tungstène. Spécial pour blocs de béton cellulaire, brique, amiante-ciment.

Mod.	TPI	Diente Tooth Dent mm	L mm	I mm		Nº Art.	€ pack
00260	2	12,7	305	250	1	72626	44,38



Mod **00270**

DEMOLICIÓN CORTE EXTRA LARGO TCT

TCT Extra Long Cut Demolition
Démolition coupe extra longue TCT



S2243HM

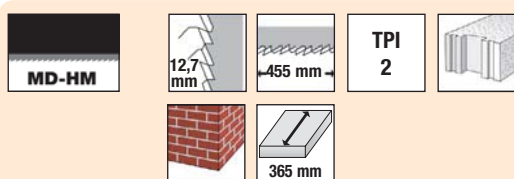

Dentado de tungsteno. Especial bloques de hormigón poroso, ladrillo, fibrocemento.

Tungsten teeth. Special for aerated concrete blocks, brick, fibre cement.

Denture Tungstène. Spécial pour blocs de béton cellulaire, brique, amiante-ciment.

Mod.	TPI	Diente Tooth Dent mm	L mm	I mm		Nº Art.	€ pack
00270	2	12,7	455	400	1	72627	54,22



Mod **00220**

HIELO Y COMIDA CONGELADA

Ice & Frozen Food
Glaces et produits surgelés



S1211K

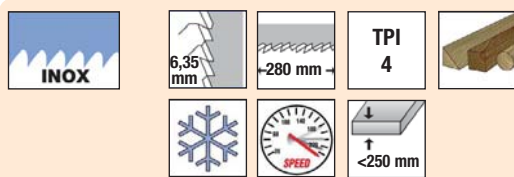

Dentado fresado y alterno de acero inoxidable. Especial comida congelada, hielo y madera.

Side set, milled teeth. Special for frozen food, ice and wood.

Denture fraisée et avoyée. Spéciale pour produits surgelés, glaces et bois.

Mod.	TPI	Diente Tooth Dent mm	L mm	I mm		Nº Art.	€ pack
00220	4	6,35	300	280	1	69020	21,24



Mod **00240**

CORTE RÁPIDO MUY LIMPIO AISLAMIENTO

Insulation Very Clean Fast Cut
Coupe rapide très propre isolant



S1213AWP

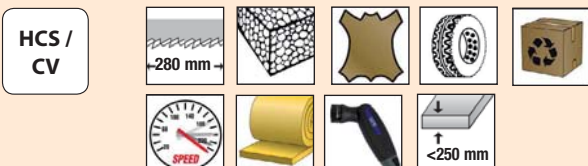

Dentado ondulado doble. Corte rápido y muy limpio en lana de roca, espuma, poliestireno, cuero, caucho, papel, cartón, alfombra.

Side set, milled teeth. Fast and very clean cutting of mineral rock wool, foam, polystyrene, rubber, paper, carton, carpet.

Denture fraisée et avoyée. Coupe rapide et très précise dans mousses, polystyrène, cuirs, caoutchouc, papiers, cartons, tapis.

Mod.	L mm	I mm		Nº Art.	€ pack
00240	300	280	5	69024	43,73



Mod **00300**

MANGO MULTIHERRAMIENTA

Multi Tool Handle
Queue multi-outils



HCS / CV

Espuma / Poliestireno
Foam / Polystyrene
Mousse / Polystyrène



MANGO MULTIHERRAMIENTA 2 en 1: atornillar y serrar

- Mango inclinable, facilita la transmisión de la fuerza
- Para lugares de difícil acceso
- Apto para sierras de sable y puntas de atornillar estándar
- Depósito para 6 puntas de atornillas (no incluidas)
- Fácil cambio de herramienta gracias a su anillo de montaje giratorio.
- Apto para uso manual en madera con Ref. 1950 mod. 00020, en metal con Ref. 1920 mod. 00200, en aislamiento y otros materiales con Ref. 1960 mod. 00240 y mod. 00280.

MULTITOOL HANDLE 2 in 1: screw and saw

- Inclinable handle for better power transmission
- Useful at places which are difficult to Access/reach
- Suitable for reciprocating saw blades and standard screw bits
- Bit magazine for 6 bits (not included)
- Easy tool change by means of a/its rotating mounting ring
- Suitable for manual use in wood with Ref. 1950 mod. 00020, in metal with Ref. 1920 mod. 00200 and in insulation and other materials with Ref. 1960 mod. 00240 and mod. 00280.

QUEUE MULTI-OUTILS 2 en 1: viser et serrer

- Queue réclinable: il rend plus facile la transmission des forces
- Pour des endroits de difficile accès
- Convenable pour scies sabres et embouts standards
- Capacité 6 embouts (pas compris)
- Changement d'outil facile grace à sa bague de montage rotative
- Conseillé pour utilisation à main en bois avec ref. 1950 mod. 00020, en métal avec ref. 1920 mod. 00200, en isolation et autres matériaux avec mod. 00240 et mod. 00280.

Mod.	Cont.		Nº Art.	€ pack
00300	1 x Mango / Handle / Queue 1 x Ref. 1960 - 00240 (Art. 69024) l=280 S1213AWP 1 x Ref. 1960 - 00280 (Art. 76688) l=205 S1113AWP	1	72851	46,25

Línea 1m
19SS

SIERRAS SABLE

Sabre Saw Blades
Lames scie sabre

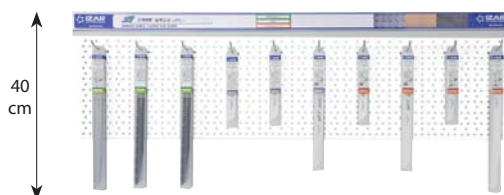

Ref.	1920	1920	1920	1950	1950	1950	1960	1960	1960	1960
	00020	00030	00050	00010	00020	00030	00020	00030	00040	00060
Pcs	3	3	3	3	3	3	3	3	3	3

Ref. 4995 - Nº Art. 72191: 669,40 €

CUADRO USO SIERRAS CALAR

Jig Saw Blade Use Table

Tableau utilisation lames scies sauteuses

						MADERA - Wood - Bois								PLÁSTICOS											
<ul style="list-style-type: none"> ● Ideal Ideal - Idéal ○ Adecuado Suitable - Convenable 						Todos tipos All types Toutes sortes		Aglomerado laminado Laminated chipboard Panneau revêtu		Blanda Soft Tendre		Dura Hard Dur		Contrachapado Plywood Contreplaqué		Parquet laminado Laminated parquet Parquet laminé		Con clavos With nails Avec clous		Aglomerado Chipboard Panneau		Plásticos Plastics		Reforzados Fibra-carbon Reinforced fibre-carbone	
Ref. - Mod.	Equiv.	Mat.	TPI	I mm	Pág.																				



Madera Wood - Bois		Ref. - Mod.	Equiv.	Mat.	TPI	I mm	Pág.															
	1940	010	T119B	HCS/CV	13	50	338															
		020	T119BO	HCS/CV	13	50	338															
		030	T111C	HCS/CV	8,5	75	339															
		040	T144D	HCS/CV	6,35	75	339	●														
		050	T244D	HCS/CV	6,35	75	340	●														
		060	T101B	HCS/CV	10	75	340	●														
		070	T101BR	HCS/CV	10	75	341	●														
		080	T101D	HCS/CV	6,35	75	341	●														
		090	T301CD	HCS/CV	8,5	105	342	●														
		100		HCS/CV	10	75	342															
		110	T144DF	Bi-metal	6,35	75	343	●														
		130	T344D	HCS/CV	6,35	105	343	●														
		140	T234X	Bi-metal	10	91	344	●														
		150	T345XF	Bi-metal	10-14	105	344	○														
		160		HCS/CV	6,35	75	345	●														
		170	T308BCP	HCS/CV	13	105	345															
		180	T301B	HCS/CV	10	91	346	●														
		200	T744D	HCS/CV	6,35	155	346	●														

Metal Metal - Métal		Ref. - Mod.	Equiv.	Mat.	TPI	I mm	Pág.															
	1910	020	T118A	HSS	21	55	347															
		040	T318A	HSS	25	105	347															
		050	T118B	HSS	13	55	348															
		060	T318B	HSS	14	105	348															
		070	T118AF	Bi-metal	21	55	349															
		090	T118BF	Bi-metal	13	55	349															
		100	T318BF	Bi-metal	14	105	350															
		110	T127D	HSS	8,5	75	350															
		120	T118AHM	CV-HM	23	50	351															
		200	T718AF	Bi-metal	12	155	351															

Especial Special		Ref. - Mod.	Equiv.	Mat.	TPI	I mm	Pág.															
	1930	020	T127DF	Bi-metal	8,5	75	352															
		030	T130RIFF	CV-HM		54	352															
		200	T341HM	CV-HM	6	105	352															



Madera Wood - Bois		Ref. - Mod.	Equiv.	Mat.	TPI	I mm	Pág.															
	1945	00030	U111C	HCS/CV	8,5	75	353															
		00040	U144D	HCS/CV	6,35	75	353	●														
		00060	U101B	HCS/CV	10	75	354	●														
		00070	U101BR	HCS/CV	10	75	354	●														

Metal Metal		Ref. - Mod.	Equiv.	Mat.	TPI	I mm	Pág.															
	1915	00020	U118A	HSS	21	55	355															
		00070	U118AF	Bi-metal	21	55	355															
		00110	U127D	Bi-metal	8,5	75	355															

SIERRAS CALAR

Jig Saw Blades

Lames scies sauteuses

Ref. **1940**

MADERA Wood Bois

Mod **010**

BÁSICA CORTE RECTO

Basic Straight Cut
Basiqie coupe droite

T119B



**NEW
PACKAGING!**

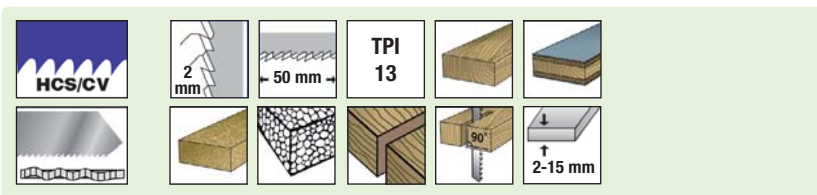

Dentado fresado y ondulado. Corte recto y limpio en madera blanda, madera contrachapada, tabla de viruta prensada, madera estratificada, tablero de fibra y materiales de aislamiento.

Milled teeth and wavy set. Straight and clean cutting of soft wood, plywood, chipboard, wood core plywood, fibre board and insulation materials.

Dents fraisés et ondulés. Coupe droite et propre dans bois tendres, contre-plaqués, agglomérés, fibres et matériaux d'isolation.

Mod.	TPI	Diente		L mm	I mm	Nº Art.	€ pack
		Tooth mm	Dent mm				
010	13	2	50	76	50	3 14129	2,64



Mod **020**

BÁSICA CORTE CURVO

Basic Curve Cut
Basiqie coupe courbe

T119BO



**NEW
PACKAGING!**

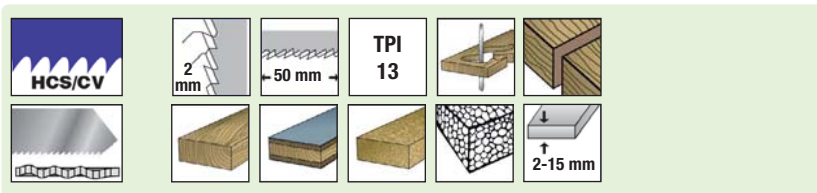

Dentado fresado y ondulado. Corte curvo y limpio en madera blanda, madera contrachapada, tabla de viruta prensada, madera estratificada, tablero de fibra y materiales de aislamiento.

Milled teeth and wavy set. Curve and clean cutting of soft wood, plywood, chipboard, wood core plywood, fibre board and insulation materials.

Dents fraisés et ondulés. Coupe courbe et propre dans bois tendres, contre-plaqués, agglomérés, fibres et matériaux d'isolation.

Mod.	TPI	Diente		L mm	I mm	Nº Art.	€ pack
		Tooth mm	Dent mm				
020	13	2	50	76	50	3 14138	3,76



Mod **030**

BÁSICA CORTE BASTO

Basic Rough Cut
Basique coupe gros

T111C



NEW PACKAGING!

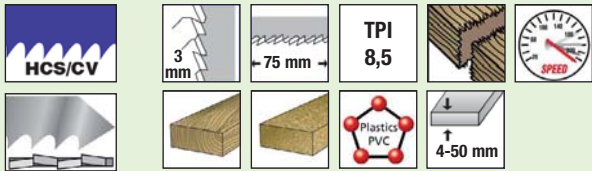

Dentado alterno. Corte basto y rápido en madera blanda, tabla de viruta prensada, madera estratificada, table-ro de fibra y plástico.

Side set toothing. Rough and fast cutting of soft wood, chipboard, wood core plywood, fibre board and plastics.

Denture avoyée et affûtée. Coupe grosso et rapide dans bois tendres, agglomérés, fibres et plastiques.

Mod.	TPI	Diente Tooth mm	Dent mm	L mm	I mm	№ Art.	€ pack
030	8,5	3	75	100	75	3 14221	2,72



Mod **040**

CORTE RÁPIDO

Fast Cut
Coupe rapide

T144D



NEW PACKAGING!

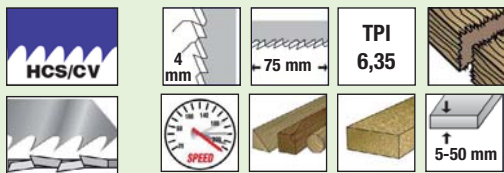

Dentado alterno y afilado diagonal. Corte rápido en todo tipo de maderas.

Side set and diagonally sharpened toothing. Fast cutting for all wood types.

Denture avoyée, dépouillée et affûtée. Coupe rapide dans différents types de bois.

Mod.	TPI	Diente Tooth mm	Dent mm	L mm	I mm	№ Art.	€ pack
040	6,35	4	75	100	75	3 14230	3,96



Mod **050**

CORTE RÁPIDO CURVO

Curve Fast Cut
Coupe rapide courbe

T244D



NEW PACKAGING!



HCS/CV	4 mm	75 mm	TPI 6,35		
				5-50 mm	

Dentado alterno y afilado diagonal. Corte rápido y curvo en todo tipo de maderas.

Side set and diagonally sharpened toothing. Fast and curve cutting for all wood types.

Denture avoyée, dépouillée et affûtée. Coupe rapide et courbe dans différents types de bois.



Mod.	TPI	Diente Tooth Dent mm	L mm	I mm		Nº Art.	€ pack
050	6,35	4	100	75	3	14231	4,51

Mod **060**

CORTE LIMPIO

Clean Cut
Coupe propre

T101B



NEW PACKAGING!



HCS/CV	2,5 mm	75 mm	TPI 10		
			LONG LIFE	3-30 mm	

Sierra rectificadо cónico y dentado afilado diagonal. Corte limpio en todo tipo de maderas y plásticos.

Conically ground blade with diagonally sharpened teeth. Clean cutting for all wood types and plastics.

Corps de la lame conique et denture dépouillée et affûtée. Coupe propre dans différents types de bois et plastiques.



Mod.	TPI	Diente Tooth Dent mm	L mm	I mm		Nº Art.	€ pack
060	10	2,5	100	75	3	14233	4,54



Mod **070**

CORTE LIMPIO SIN ASTILLAS

Splinterfree Clean Cut
Coupe propre sans éclat

T101BR



**NEW
PACKAGING!**

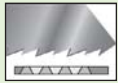
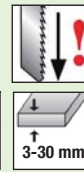

Sierra rectificado cónico y dentado afilado diagonal. Dentado inverso. Corte limpio sin astillas en todo tipo de maderas y plásticos.

Conically ground blade with diagonally sharpened teeth. Reverse teeth. Clean splinterfree cutting for all wood types and plastics.

Corps de la lame conique et denture dépouillée et affûtée. Denture inversée. Coupe propre sans éclats dans différents types de bois et plastiques.

Mod.	TPI	Diente Tooth Dent mm	L mm	I mm	3	Nº Art.	€ pack
070	10	2,5	100	75	3	14236	5,60



Mod **080**

CORTE LIMPIO RÁPIDO

Fast Clean Cut
Coupe propre rapide

T101D



**NEW
PACKAGING!**

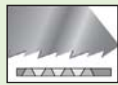
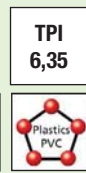
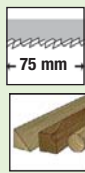
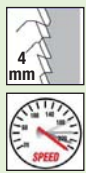

Sierra rectificado cónico y dentado afilado diagonal. Corte limpio y rápido en todo tipo de maderas y plásticos.

Conically ground blade with diagonally sharpened teeth. Clean and fast cutting for all wood types and plastics.

Corps de la lame conique et denture dépouillée et affûtée. Coupe propre et rapide dans différents types de bois et plastiques.

Mod.	TPI	Diente Tooth Dent mm	L mm	I mm	3	Nº Art.	€ pack
080	6,35	4	100	75	3	14243	4,54



Mod

100

CORTE LIMPIO CURVO

Curve Clean Cut
Coupe propre courbe



NEW PACKAGING!

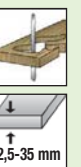
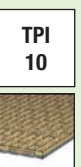
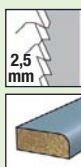

Sierra rectificado cónico y dentado afilado diagonal. Corte limpio y curvo en madera blanda, aglomerado, laminado, parqué.

Conically ground blade with diagonally sharpened teeth. Clean and curve cutting for soft wood, chipboard, laminated board, parquett.

Corps de la lame conique et denture dépouillée et affûtée. Coupe propre et courbe dans bois tendres, agglomérés, panneaux en bois, parquets.

Mod.	TPI	Diente Tooth Dent mm	L mm	I mm		Nº Art.	€ pack
100	10	2,5	100	75	3	14302	6,23



Mod

090

CORTE LIMPIO LARGO

Long Clean Cut
Coupe propre longue

T301CD



NEW PACKAGING!

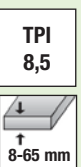
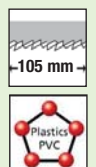
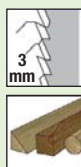

Sierra rectificado cónico y dentado afilado diagonal. Corte limpio y largo en todo tipo de maderas y plásticos.

Conically ground blade with diagonally sharpened teeth. Clean and long cutting for all wood types and plastics.

Corps de la lame conique et denture dépouillée et affûtée. Coupe propre et longue dans différents types de bois et plastiques.

Mod.	TPI	Diente Tooth Dent mm	L mm	I mm		Nº Art.	€ pack
090	8,5	3	132	105	3	14246	5,93



Mod

110

CORTE RÁPIDO ALTO RENDIMIENTO

Long Life Fast Cut
Coupe rapide longue durée

T144DF

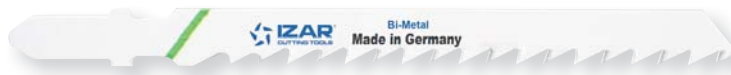

NEW PACKAGING!

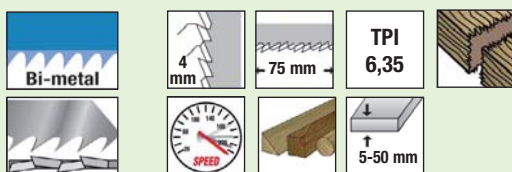

Dentado alterno y afilado diagonal. Corte rápido en todo tipo de maderas. Alto rendimiento.

Side set and diagonally sharpened toothing. Fast cutting for all wood types. Long lifetime.

Denture avoyée, dépouillée et affûtée. Coupe rapide dans différents types de bois. Durée de vie plus longue.

Mod.	TPI	Diente Tooth Dent mm	L mm	l mm		Nº Art.	€ pack
110	6,35	4	100	75	3	14306	7,88

Mod

130

CORTE RÁPIDO LARGO

Long Fast Cut
Coupe rapide longue

T344D



NEW PACKAGING!

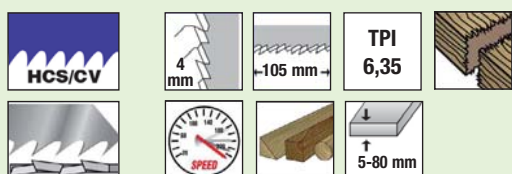

Dentado alterno y afilado diagonal. Corte rápido y largo en todo tipo de maderas.

Side set and diagonally sharpened toothing. Fast and long cutting for all wood types.

Denture avoyée, dépouillée et affûtée. Coupe rapide et longue dans différents types de bois.

Mod.	TPI	Diente Tooth Dent mm	L mm	l mm		Nº Art.	€ pack
130	6,35	4	132	105	3	14307	4,91



Mod **140**

CORTE LIMPIO RÁPIDO

Fast Clean Cut
Coupe propre rapide

NEW
PACKAGING!



T234X

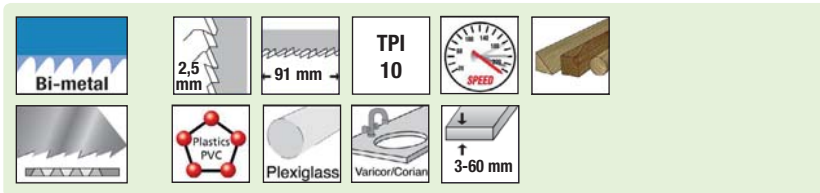

Sierra rectificado cónico y dentado afilado triple. Corte limpio y rápido en todo tipo de maderas y plásticos.

Conically ground blade with 3-times sharpened teeth. Clean and fast cutting for all wood types and plastics.

Corps de la lame conique avec denture affûtée triple. Coupe propre et rapide dans différents types de bois et plastiques.

Mod.	TPI	Diente Tooth mm	Dent mm	L mm	I mm	Nº Art.	€ pack
140	10	2,5	91	117	91	3 14326	9,07



Mod **150**

CORTE LARGO FLEXIBLE ALTO RENDIMIENTO

Long Life Flexible Long Cut
Coupe longue flexible longue durée

NEW
PACKAGING!



T345XF

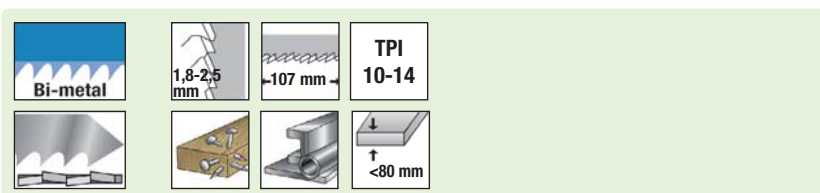

Dentado fresado alterno. Sierra larga y flexible para madera con residuos de metal, tubos y perfiles de acero (2,5-10 mm). Gran rendimiento.

Milled and side teeth. Long and flexible blade for wood with metal residues, steel pipes and profiles (2,5-10 mm). Long lifetime.

Dents fraisés et avoyés. Lame très longue et flexible pour bois avec métaux résiduels, tubes et profils en acier (2,5-10 mm). Durée de vie plus longue.

Mod.	TPI	Diente Tooth mm	Dent mm	L mm	I mm	Nº Art.	€ pack
150	10-14	1,8-2,5	107	132	107	3 14327	11,10

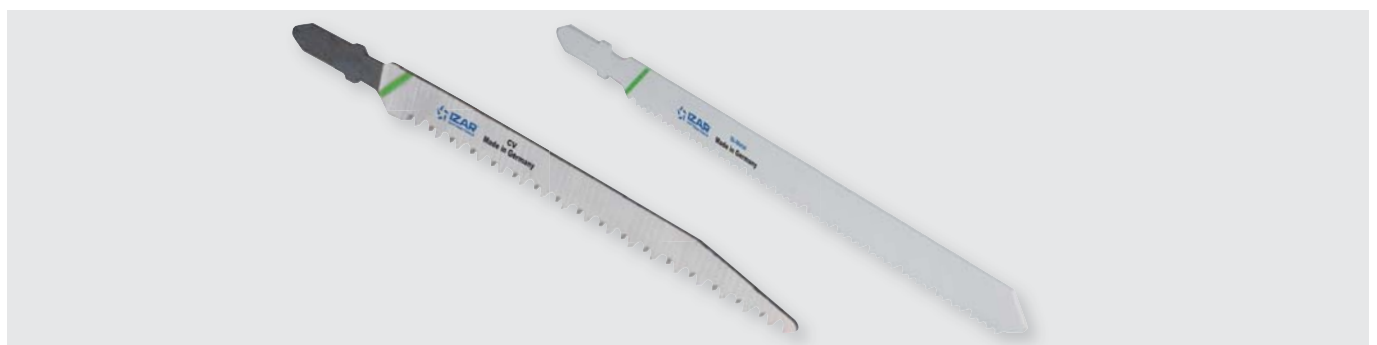

Mod

160

CORTE RÁPIDO CURVO

Curve Fast Cut
Coupe rapide courbe

NEW PACKAGING!

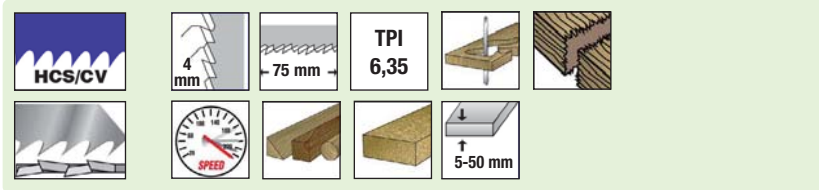

Dentado doble alterno y afilado diagonal. Corte rápido y curvo en todo tipo de maderas.

Double side set and diagonally sharpened toothing. Fast and curve cutting for all wood types.

Denture double avoyée, dépouillée et affûtée. Coupe rapide et courbe dans différents types de bois.

Mod.	TPI	Diente Tooth Dent mm	L mm	I mm	Nº Art.	€ pack
160	6,35	4	100	75	3 14328	11,86



Mod

170

CORTE LIMPIO RÁPIDO

Fast Clean Cut
Coupe propre rapide

NEW PACKAGING!



T308BCP

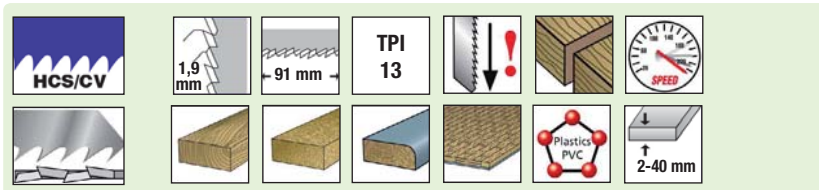

Sierra rectificación cónica y dentado afilado inverso. Corte limpio y rápido en madera blanda, aglomerado, tablero de fibra, laminado, parqué, laminado plástico.

Conically ground blade with reverse sharpened teeth. Clean and fast cutting for all wood types and plastics.

Corps de la lame conique denture renversée et affûtée. Coupe propre et rapide dans différents types de bois et plastiques.

Mod.	TPI	Diente Tooth Dent mm	L mm	I mm	Nº Art.	€ pack
170	13	1,9	117	91	3 14331	4,90



Mod **180**

CORTE LIMPIO

Clean Cut
Coupe propre

NEW
PACKAGING!



T301B

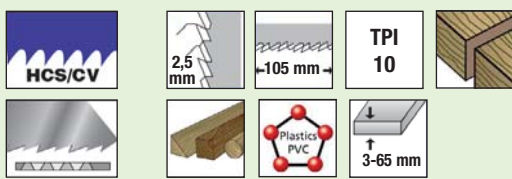

Sierra rectificado cónico y dentado afilado diagonal.
Corte limpio en todo tipo de maderas y plásticos.

Conically ground blade with diagonally sharpened teeth.
Clean cutting for all wood types and plastics.

Corps de la lame conique denture dépouillée et affûtée.
Coupe propre dans différents types de bois et plastiques.

Mod.	TPI	Diente Tooth Dent mm	L mm	I mm	Nº Art.	€ pack
180	10	2,5	132	105	14332	8,19



Mod **200**

CORTE RÁPIDO MUY LARGO

Very Long Fast Cut
Coupe rapide très longue

NEW
PACKAGING!



T744D



Dentado alterno y afilado diagonal. Corte rápido y muy largo en todo tipo de maderas.

Side set and diagonally sharpened tothing. Fast and very long cutting for all wood types.

Denture avoyée, dépouillée et affûtée. Coupe rapide et très longue dans différents types de bois.

Mod.	TPI	Diente Tooth Dent mm	L mm	I mm	Nº Art.	€ pack
200	6,35	4	180	155	14334	8,80



Mod **020**

CORTE LÁMINAS FINAS ACERO

Thin Steel Sheet Cut
Coupe tôles fines acier

**NEW
PACKAGING!**



T118A



TPI
21

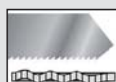

↑
1,2-2 mm

Dentado fresado y ondulado. Láminas finas de acero.
Milled teeth and wavy set. Thin steel sheets.
Dents fraisés et ondulés. Tôles fines.



Mod.	TPI	Diente Tooth Dent mm	L mm	I mm		Nº Art.	€ pack
020	21	1,2	76,5	55	3	14336	4,53

Mod **040**

CORTE LARGO LÁMINAS FINAS ACERO

Thin Steel Sheet Long Cut
Coupe longue tôles fines acier

**NEW
PACKAGING!**



T318A

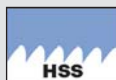

TPI
25

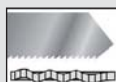

↑
1-3 mm

Dentado fresado y ondulado. Sierra larga para láminas finas de acero, tubos, perfiles y material tipo sandwich hasta 80 mm.

Milled teeth and wavy set. Long blade for thin steel sheets, pipes, profiles and sandwich-material up to 80 mm.

Dents fraisés et ondulés. Lame longue pour tôles fines, profils, tubes et matériel sandwich jusqu'à 80 mm.

Mod.	TPI	Diente Tooth Dent mm	L mm	I mm		Nº Art.	€ pack
040	25	1	132	105	3	14339	7,46



Mod **050**

CORTE ACEROS, NO FERROSOS, ALUMINIO

Steel, Non-Ferrous, Aluminium Cut
Coupe Aciers, Non ferreux, Aluminium

NEW PACKAGING!



T118B

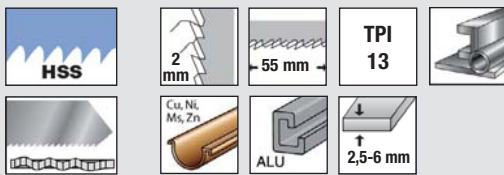

Dentado fresado y ondulado. Aceros, metales no ferrosos y aluminio.

Milled teeth and wavy set. Steel, non-ferrous metal and aluminium.

Dents fraisés et ondulés. Aciers, métaux non ferreux et aluminiums.

Mod.	TPI	Diente Tooth Dent mm	L mm	I mm	Nº Art.	€ pack
050	13	2	76,5	55	3 14349	4,53



Mod **060**

CORTE LARGO FLEXIBLE

Flexible Long Cut
Coupe longue flexible

NEW PACKAGING!



T318B



Dentado fresado y ondulado. Sierra larga y flexible para aceros, tubos, perfiles, material tipo sandwich hasta 80 mm y metales no ferrosos. Alto rendimiento.

Milled teeth and wavy set. Long and flexible blade for steel, pipes, profiles, sandwich-material up to 80 mm and non-ferrous metals. Long life.

Dents fraisés et ondulés. Lame longue et flexible pour aciers, profils, tubes, matériel sandwich jusqu'à 80 mm et métal non ferreux. Durée de vie plus longue.

Mod.	TPI	Diente Tooth Dent mm	L mm	I mm	Nº Art.	€ pack
060	14	1,8	132	105	3 14351	6,91



Mod **070**

CORTE FLEXIBLE ALTO RENDIMIENTO

Long Life Flexible Cut
Coupe flexible longue durée

**NEW
PACKAGING!**



T118AF



			TPI 21	

Dentado fresado y ondulado. Sierra flexible para aceros e inoxidables. Alto rendimiento.

Milled teeth and wavy set. Flexible blade for steel and stainless steel. Long life.

Dents fraisés et ondulés. Lame longue et flexible pour aciers et inoxydables. Durée de vie plus longue.

Mod.	TPI	Diente		L	l		Nº	€
		Tooth	Dent	mm	mm		Art.	pack
		mm	mm					
070	21	1,2		76,5	55	3	14352	5,88

Mod **090**

CORTE FLEXIBLE ALTO RENDIMIENTO

Long Life Flexible Cut
Coupe flexible longue durée

**NEW
PACKAGING!**



T118BF



			TPI 13				

Dentado fresado y ondulado. Sierra flexible para aceros e inoxidables, metales no ferrosos y aluminio. Alto rendimiento.

Milled teeth and wavy set. Flexible blade for steel and stainless steel, non-ferrous metals and aluminium. Long life.

Dents fraisés et ondulés. Lame longue et flexible pour aciers et inoxydables, métaux non ferreux et aluminium. Durée de vie plus longue.

Mod.	TPI	Diente		L	l		Nº	€
		Tooth	Dent	mm	mm		Art.	pack
		mm	mm					
090	13	2		76,5	55	3	14353	5,88



Mod **100**

CORTE LARGO FLEXIBLE ALTO RENDIMIENTO

Long Life Flexible Long Cut
Coupe longue flexible longue durée

NEW PACKAGING!



T318BF

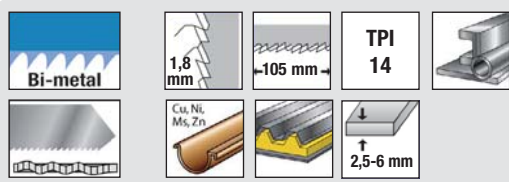

Dentado fresado y ondulado. Sierra larga y flexible para aceros, tubos, perfiles, material tipo sandwich hasta 80 mm y metales no ferrosos. Alto rendimiento.

Milled teeth and wavy set. Long and flexible blade for steel, pipes, profiles, sandwich-material up to 80 mm and non-ferrous metals. Long life.

Dents fraisés et ondulés. Lame longue et flexible pour aciers, profils, tubes, matériel sandwich jusqu'à 80 mm et métaux non ferreux. Durée de vie plus longue.

Mod.	TPI	Diente Tooth Dent mm	L mm	I mm	№ Art.	€ pack
100	14	1,8	132	105	3 14358	10,73



Mod **110**

CORTE ACEROS, NO FERROSOS, ALUMINIO, PLÁSTICO

Steel, Non-Ferrous, Aluminium, Plastic Cut
Coupe Aciers, Non ferreux, Aluminium, Plastique

NEW PACKAGING!



T127D

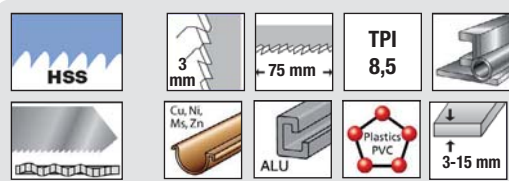

Dentado fresado alterno. Aceros, metales no ferrosos, aluminio y plásticos.

Milled teeth and side set. Steel, non-ferrous metals, aluminium and plastics.

Dents fraisés et avoyés. Aciers, métaux non ferreux, aluminiums et plastiques.

Mod.	TPI	Diente Tooth Dent mm	L mm	I mm	№ Art.	€ pack
110	8,5	3	100	75	3 14372	5,64



Mod **120**

METAL DURO PULVERIZADO

Grinded Carbide
Carbure pulvérisé

NEW PACKAGING!



T118AHM

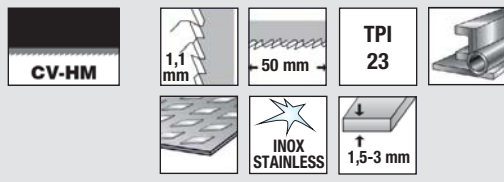

Banda de metal duro pulverizado. Aceros, planchas de metal e inoxidables.

Grinded carbide strip. Steel, metal sheets and stainless steel.

Dents en carbure. Aciers, tôles et aciers inoxydables.

Mod.	TPI	Diente Tooth Dent mm	L mm	I mm	📦 Nº Art.	€ pack
120	23	1,1	79	50	1	14379 17,47



Mod **200**

CORTE LARGO FLEXIBLE CONSTRUCCIÓN ALTO RENDIMIENTO

Long Life Construction Flexible Long Cut
Coupe longue flexible construction longue durée

NEW PACKAGING!



T718AF

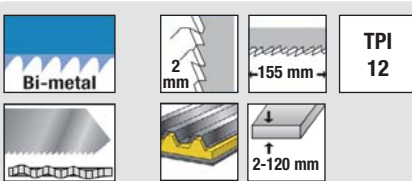

Dentado fresado y ondulado. Sierra larga y flexible para construcción de fachadas y material tipo sandwich. Alto rendimiento.

Milled teeth and wavy set. Long and flexible blade for facade construction and sandwich-material. Long life.

Dents fraisés et ondulés. Lame longue et flexible pour les façades et matériel sandwich. Durée de vie plus longue

Mod.	TPI	Diente Tooth Dent mm	L mm	I mm	📦 Nº Art.	€ pack
200	12	2	180	155	3	14380 12,96



Mod **020**

CORTE FLEXIBLE METAL, PLÁSTICO

Plastic, Metal Flexible Cut
Coupe flexible Métal, Plastique

NEW PACKAGING!



T127DF

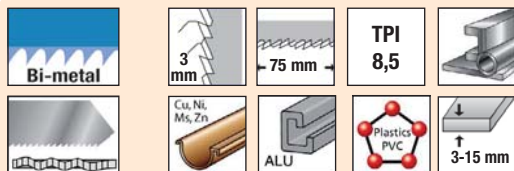

Dentado fresado alterno. Sierra flexible para aceros, metales no ferrosos, aluminio (3-15 mm) y plásticos (3-30 mm).

Milled teeth and side set. Flexible blade for steel, non-ferrous metals, aluminium (3-15 mm) and plastics (3-30 mm).

Dents fraisés et avoyés. Lame flexible pour aciers, métaux non ferreux, aluminiums (3-15 mm) et plastiques (3-30 mm).

Mod.	TPI	Diente		L mm	I mm	Nº Art.	€ pack
		Tooth mm	Dent mm				
020	8,5	3	3	100	75	3 14386	7,73



Mod **030**

CORTE VIDRIO, CERÁMICA

Ceramic, Glass Cut
Coupe Verre, Céramique

NEW PACKAGING!



T130RIFF



Recubrimiento de metal duro de grano grueso. Vidrio, cerámica y productos reforzados con fibra de vidrio.

Carbide coated, coarse-grained. Glass, ceramics, glass-fibre reinforced products.

Revêtement en carbure, gros grains. Verre, céramique, fibre de verre.

Mod.	L mm	I mm	Nº Art.	€ pack
030	79	54	1 14387	4,17



Mod **200**

DENTADO METAL DURO TUNGSTENO

Tungsten Carbide Teeth
Denture carbure Tungstène

NEW PACKAGING!



T341HM

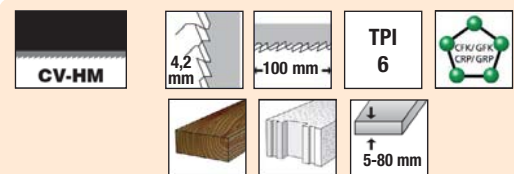

Dentado metal duro tungsteno. Fibra de vidrio, madera dura y hormigón gaseoso.

Carbide coated, coarse-grained. Glass-fibre, hard wood and gas formed concrete.

Revêtement en carbure, gros grains. Fibre de verre, bois durs et béton.

Mod.	TPI	Diente		L mm	I mm	Nº Art.	€ pack
		Tooth mm	Dent mm				
200	6	4,2	4,2	132	100	1 14390	12,12



Mod **00030**

BÁSICA CORTE BASTO RÁPIDO

Basic Fast Rough Cut
Basique coupe gros rapide



U111C



Dentado alterno. Corte basto y rápido en madera blanda, tabla de viruta prensada, madera estratificada, table-ro de fibra y plástico.

Side set toothing. Rough and fast cutting of soft wood, chipboard, wood core plywood, fibre board and plastics.

Denture avoyée et affûtée. Coupe grosse et rapide dans bois tendres, agglomérés, fibres et plastiques.

Mod.	TPI	Diente Tooth Dent mm	L mm	I mm		Nº Art.	€ pack
00030	8,5	3	100	75	5	21883	5,18



Mod **00040**

CORTE RÁPIDO

Fast Cut
Coupe rapide



U144D



Dentado alterno y afilado diagonal. Corte rápido en todo tipo de maderas.

Side set and diagonally sharpened toothing. Fast cutting for all wood types.

Denture avoyée, dépouillée et affûtée. Coupe rapide dans différents types de bois.

Mod.	TPI	Diente Tooth Dent mm	L mm	I mm		Nº Art.	€ pack
00040	6,35	4	100	75	5	21884	7,21



Mod **00060**

CORTE LIMPIO

Clean Cut
Coupe propre



U101B

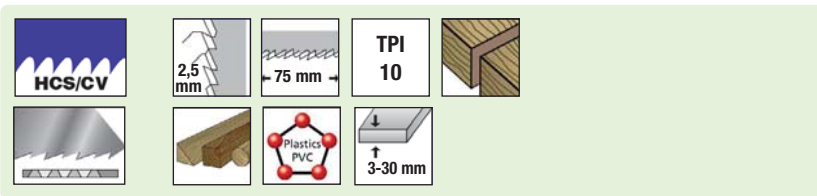

Sierra rectificado cónico y dentado afilado diagonal. Corte limpio en todo tipo de maderas y plásticos.

Conically ground blade with diagonally sharpened teeth. Clean cutting for all wood types and plastics.

Corps de la lame conique et denture dépouillée et affûtée. Coupe propre dans différents types de bois et plastiques.

Mod.	TPI	Diente Tooth Dent mm	L mm	I mm	N° Art.	€ pack
00060	10	2,5	100	75	21885	8,51



Mod **00070**

CORTE LIMPIO SIN ASTILLAS

Splinterfree Clean Cut
Coupe propre sans éclat



U101BR

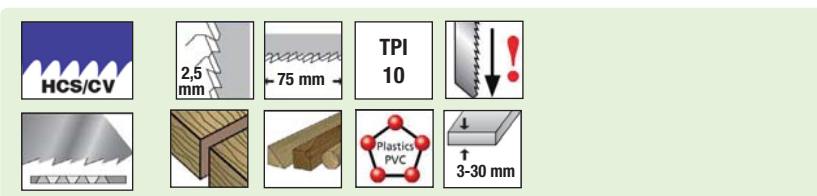

Sierra rectificado cónico y dentado afilado diagonal. Dentado inverso. Corte limpio sin astillas en todo tipo de maderas y plásticos.

Conically ground blade with diagonally sharpened teeth. Reverse teeth. Clean splinterfree cutting for all wood types and plastics.

Corps de la lame conique et denture dépouillée et affûtée. Denture inversée. Coupe propre sans éclats dans différents types de bois et plastiques.

Mod.	TPI	Diente Tooth Dent mm	L mm	I mm	N° Art.	€ pack
00070	10	2,5	100	75	21886	8,51



Mod **00020**

CORTE LÁMINAS FINAS ACERO

Thin Steel Sheet Cut
Coupe tôles fines acier

U118A

21892



HSS
Made in Germany

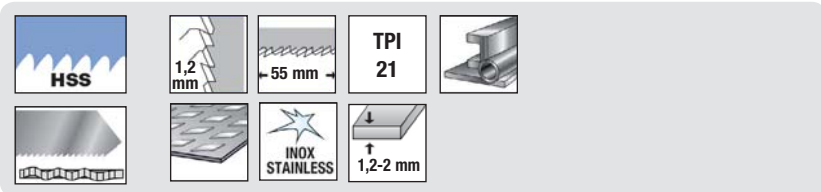

Dentado fresado y ondulado. Láminas finas de acero e inoxidable.

Milled teeth and wavy set. Thin steel and stainless steel sheets.

Dents fraisés et ondulés. Tôles fines en acier et inoxydable.

Mod.	TPI	Diente Tooth Dent mm	L mm	I mm		Nº Art.	€ pack
00020	21	1,2	76,5	55	5	21892	8,62



Mod **00070**

CORTE FLEXIBLE ALTO RENDIMIENTO

Long Life Flexible Cut
Coupe flexible longue durée

U118AF

21893



Bi-Metal
Made in Germany

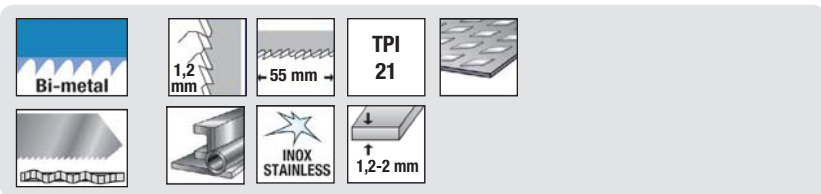

Dentado fresado y ondulado. Sierra flexible para aceros e inoxidables. Alto rendimiento.

Milled teeth and wavy set. Flexible blade for steel and stainless steel. Long life.

Dents fraisés et ondulés. Lame longue et flexible pour aciers et inoxydables. Durée de vie plus longue.

Mod.	TPI	Diente Tooth Dent mm	L mm	I mm		Nº Art.	€ pack
00070	21	1,2	76,5	55	5	21893	13,08



Mod **00110**

CORTE ACEROS, NO FERROSOS, ALUMINIO, PLÁSTICO

Steel, Non-Ferrous, Aluminium, Plastic Cut
Coupe Aciers, Non ferreux, Aluminium, Plastique

U127D

21894



Bi-Metal
Made in Germany

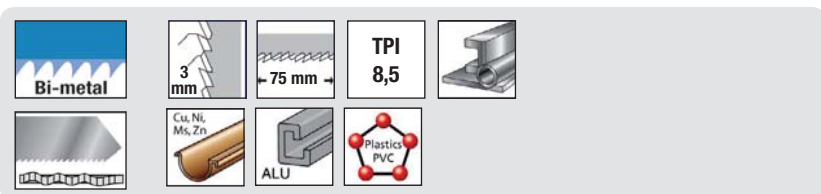

Dentado fresado alterno. Aceros, metales no ferrosos, aluminio y plásticos.

Milled teeth and side set. Steel, non-ferrous metals, aluminium and plastics.

Dents fraisés et avoyés. Aciers, métaux non ferreux, aluminiums et plastiques.

Mod.	TPI	Diente Tooth Dent mm	L mm	I mm		Nº Art.	€ pack
00110	8,5	3	100	75	5	21894	11,30



Línea 1m 19C1

SIERRAS CALAR INSERCIÓN "T"

"T" Insertion Jig Saw Blades

Lames scies insertion "T"

23
cm



Ref.	1910	1910	1910	1910	1910	1910	1910	1910	1930	1930	1940	1940	1940	1940	1940	1940	1940	1940	1940
	020	040	050	060	070	090	100	110	020	030	010	020	030	040	050	060	070	080	100
Pcs	5	5	5	5	5	5	5	5	5	5	5	5	5	5	5	5	5	5	5

Ref. 4995 - Nº Art. 72195: 509,70 €

Línea 1m 19C2

SIERRAS CALAR INSERCIÓN "T" + "U"

"T" + "U" Insertion Jig Saw Blades

Lames scies insertion "T" + "U"

24
cm



Ref.	1910	1910	1910	1910	1910	1915	1915	1940	1940	1940	1940	1940	1940	1940	1940	1945	1945	1945	1945
	020	040	050	070	100	00070	00110	010	030	040	060	070	080	100	140	00030	00040	00060	00070
Pcs	5	5	5	5	5	5	5	5	5	5	5	5	5	5	5	5	5	5	5

Ref. 4995 - Nº Art. 72196: 631,06 €

Display 20

SIERRAS CALAR INSERCIÓN "T"

"T" Insertion Jig Saw Blades

Lames scies insertion "T"



		Ref. 1940							
Mod.		Mod. 010	Mod. 020	Mod. 030	Mod. 030	Mod. 040	Mod. 040	Mod. 050	Mod. 060
Pcs		3	3	2	1	2	1	3	2
		Ref. 1940				Ref. 1930			
Mod.		Mod. 060	Mod. 070	Mod. 070	Mod. 080	Mod. 100	Mod. 020	Mod. 030	Mod. 200
Pcs		1	2	1	3	3	3	3	3
		Ref. 1910							
Mod.		Mod. 020	Mod. 040	Mod. 050	Mod. 060	Mod. 070	Mod. 090	Mod. 100	Mod. 110
Pcs		3	3	3	3	3	3	3	3

Ref. 4995 - Nº Art. 22391: 342,16 €

Display 21

SIERRAS CALAR INSERCIÓN "T" + "U"

"T" + "U" Insertion Jig Saw Blades

Lames scies insertion "T" + "U"



		Ref. 1940							
Mod.		Mod. 010	Mod. 030	Mod. 040	Mod. 060	Mod. 070	Mod. 080	Mod. 100	Mod. 140
Pcs		3	3	3	3	3	3	3	3
		Ref. 1910				Ref. 1930			
Mod.		Mod. 020	Mod. 040	Mod. 050	Mod. 070	Mod. 100	Mod. 020	Mod. 030	Mod. 200
Pcs		2	2	2	2	2	1	1	1
		Ref. 1945				Ref. 1915			
Mod.		Mod. 00030	Mod. 00040	Mod. 00060	Mod. 00060	Mod. 00070	Mod. 00020	Mod. 00070	Mod. 00110
Pcs		3	3	2	1	3	2	2	2

Ref. 4995 - Nº Art. 22280: 362,37 €



PUNTAS ATORNILLAR

Screwdriver Bits

Embouts vissage



PUNTAS ATORNILLAR

Screwdriver Bits - Embouts vissage

Ref. **1520**

PUNTA ATORNILLAR

Screwdriver Bit
Embout vissage

Standard

d =
6,35 mm



GAMA
Range
Gamme

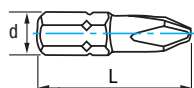

2
Uds



5
Uds



25
Uds



50
Uds



100
Uds

Tipo Type	D mm	L mm	DIN	Nº Art.	€ pack	Nº Art.	€ pack	Nº Art.	€ pack	Nº Art.	€ pack	Nº Art.	€ pack
--------------	---------	---------	-----	------------	-----------	------------	-----------	------------	-----------	------------	-----------	------------	-----------

ALLEN



HEX	2	25	C 6.3	23418	1,23	23425	2,68	23426	12,06	23429	22,91		
HEX	2,5	25	C 6.3	23430	1,23	23431	2,68	23432	12,06	23433	22,91		
HEX	3	25	C 6.3	83771	1,23	33154	2,68	23445	12,06	23446	22,91		
HEX	4	25	C 6.3	83772	1,23	33155	2,68	23447	12,06	23448	22,91		
HEX	5	25	C 6.3	83773	1,23	33156	2,68	23449	12,06	23450	22,91		
HEX	6	25	C 6.3	23451	1,23	23453	2,68	23454	12,06	23455	22,91		
HEX	7	35	C 6.3	23456	1,28	23457	2,80	23458	12,60	23459	23,94		
HEX	8	35	C 6.3	23460	1,28	23461	2,80	23462	12,60	23463	23,94		

PHILLIPS



PH	0	25	C 6.3	23464	1,23	23465	2,68	23466	12,06	23468	22,91		
PH	1	25	C 6.3	83774	1,23	33138	2,68	23469	12,06	23470	22,91		
PH	2	25	C 6.3	83776	1,23	33139	2,68	23473	12,06	23475	22,91	23476	43,54
PH	3	25	C 6.3	83778	1,23	33140	2,68	23482	12,06	23483	22,91		
PH	4	35	C 6.3	23505	1,28	23506	2,80	23509	12,60	23511	23,94		
PH	1	50	E 6.3	83775	1,90	22647	4,04	23471	18,17	23472	34,52		
PH	2	50	E 6.3	83777	1,90	22654	4,04	23477	18,17	23478	34,52	23479	65,59
PH	3	50	E 6.3	83779	1,90	22659	4,04	23503	18,17	23504	34,52		

POZIDRIVE



PZ	0	25	C 6.3	23513	1,23	23515	2,68	23561	12,06	23562	22,91		
PZ	1	25	C 6.3	83780	1,23	33141	2,68	23570	12,06	23571	22,91		
PZ	2	25	C 6.3	83782	1,23	33142	2,68	23585	12,06	23588	22,91	23589	43,54
PZ	3	25	C 6.3	83784	1,23	33143	2,68	23594	12,06	23596	22,91		
PZ	4	35	C 6.3	23600	1,28	23601	2,80	23602	12,60	23606	23,94		
PZ	1	50	E 6.3	83781	1,90	23578	4,04	23579	18,17	23580	34,52		
PZ	2	50	E 6.3	83783	1,90	22663	4,04	23590	18,17	23592	34,52	23593	65,59
PZ	3	50	E 6.3	83785	1,90	22664	4,04	23597	18,17	23599	34,52		

PLANA / Flat / Plate



SL	3,0x0,5	25	C 6.3	23609	1,23	23615	2,68	23616	12,06	23618	22,91		
SL	4,0x0,5	25	C 6.3	23619	1,23	23620	2,68	23622	12,06	23624	22,91		
SL	4,5x0,6	25	C 6.3	83786	1,23	33151	2,68	23669	12,06	23672	22,91		
SL	5,5x0,8	25	C 6.3	83787	1,23	33152	2,68	23693	12,06	23702	22,91		
SL	5,5x1,0	25	C 6.3	23735	1,23	23738	2,68	23741	12,06	23750	22,91		
SL	6,0x1,0	25	C 6.3	23751	1,23	23752	2,68	23754	12,06	23755	22,91		
SL	6,5x1,2	25	C 6.3	83788	1,23	33153	2,68	23757	12,06	23758	22,91		
SL	8,0x1,2	30	C 6.3	23770	1,28	23772	2,80	23773	12,60	23774	23,94		
SL	4,0x0,5	50	E 6.3	23627	1,90	23638	4,05	23660	18,23	23663	34,63		
SL	4,5x0,6	50	E 6.3	23678	1,90	22666	4,05	23681	18,23	23683	34,63		
SL	5,5x0,8	50	E 6.3	23705	1,90	22668	4,05	23714	18,23	23723	34,63		
SL	6,5x1,2	50	E 6.3	23760	1,90	22669	4,05	23766	18,23	23769	34,63		

Ref. **1520**

PUNTA ATORNILLAR

Screwdriver Bit
Embout vissage

+ GAMA
Range
Gamme



Tipo	D	L	DIN	Nº	€	Nº	€	Nº	€	Nº	€	Nº	€
Type	mm	mm		Art.	pack	Art.	pack	Art.	pack	Art.	pack	Art.	pack

TORX



TX	5	25	C 6.3	23805	1,28	23806	2,80	23807	12,60	23816	23,94		
TX	6	25	C 6.3	23817	1,28	23818	2,80	23819	12,60	23820	23,94		
TX	7	25	C 6.3	23821	1,28	23822	2,80	23832	12,60	23833	23,94		
TX	8	25	C 6.3	23835	1,28	66723	2,80	23837	12,60	23838	23,94		
TX	9	25	C 6.3	23848	1,28	23851	2,80	23853	12,60	23854	23,94		
TX	10	25	C 6.3	83789	1,28	33144	2,80	23855	12,60	23856	23,94		
TX	15	25	C 6.3	83791	1,28	33145	2,80	23859	12,60	23860	23,94	23861	45,49
TX	20	25	C 6.3	83793	1,28	33146	2,80	23866	12,60	23869	23,94	23872	45,49
TX	25	25	C 6.3	83795	1,28	33147	2,80	23877	12,60	23878	23,94	23879	45,49
TX	27	25	C 6.3	23907	1,28	33148	2,80	23908	12,60	23910	23,94		
TX	30	25	C 6.3	83797	1,28	33149	2,80	23915	12,60	23919	23,94	23920	45,49
TX	40	25	C 6.3	83799	1,28	33150	2,80	23924	12,60	23925	23,94		
TX	10	50	E 6.3	83790	2,00	22671	4,25	23857	19,13	23858	36,34		
TX	15	50	E 6.3	83792	2,00	22674	4,25	23863	19,13	23864	36,34		
TX	20	50	E 6.3	83794	2,00	22675	4,25	23873	19,13	23874	36,34	23875	69,04
TX	25	50	E 6.3	83796	2,00	22676	4,25	23894	19,13	23905	36,34	23906	69,04
TX	27	50	E 6.3	23911	2,00	22677	4,25	23912	19,13	23913	36,34		
TX	30	50	E 6.3	83798	2,00	22678	4,25	23921	19,13	23922	36,34	23923	69,04
TX	40	50	E 6.3	83800	2,00	22683	4,25	23926	19,13	23927	36,34		

TORX SEGURIDAD

Security Torx / Torx Sécurité



TS	10	25	C 6.3	31098	1,34	23949	2,85	23950	12,81	23951	24,35		
TS	15	25	C 6.3	31099	1,34	23952	2,85	23954	12,81	23956	24,35		
TS	20	25	C 6.3	31100	1,34	23959	2,85	23960	12,81	23961	24,35		
TS	25	25	C 6.3	31101	1,34	23962	2,85	23963	12,81	23964	24,35		
TS	27	25	C 6.3	31102	1,34	23965	2,85	23966	12,81	23967	24,35		
TS	30	25	C 6.3	31103	1,34	23970	2,85	23972	12,81	23973	24,35		
TS	40	25	C 6.3	31104	1,34	23974	2,85	23975	12,81	23998	24,35		

SQUARE ROBERTSON



SQ	1	25	C 6.3	23775	3,50	23776	7,44	23778	33,47	23779	63,59		
SQ	2	25	C 6.3	23786	3,50	23787	7,44	23788	33,47	23789	63,59		
SQ	3	25	C 6.3	23795	3,50	23796	7,44	23797	33,47	23798	63,59		
SQ	1	50	E 6.3	23781	5,38	23782	11,44	23784	51,49	23785	97,83		
SQ	2	50	E 6.3	23790	5,38	23791	11,44	23792	51,49	23794	97,83		
SQ	3	50	E 6.3	23799	5,38	23801	11,44	23802	51,49	23804	97,83		

TRIWING



TRW	1	25	C 6.3	23928	13,90	23929	29,54	23930	132,92				
TRW	2	25	C 6.3	23931	13,90	23932	29,54	23933	132,92				
TRW	3	25	C 6.3	23934	13,90	23935	29,54	23936	132,92				
TRW	4	25	C 6.3	23937	13,90	23938	29,54	23939	132,92				
TRW	5	25	C 6.3	23940	13,90	23941	29,54	23942	132,92				
TRW	6	25	C 6.3	23943	13,90	23944	29,54	23945	132,92				
TRW	8	25	C 6.3	23946	13,90	23947	29,54	23948	132,92				

XZN



XZN	4	25	C 6.3	24016	9,50	24027	20,19	24029	90,84				
XZN	5	25	C 6.3	24031	9,50	24032	20,19	24033	90,84				
XZN	6	25	C 6.3	24034	9,50	24041	20,19	24043	90,84				
XZN	8	25	C 6.3	24045	9,50	24046	20,19	24047	90,84				
XZN	10	25	C 6.3	24056	9,50	24117	20,19	24120	90,84				

Display 63



PUNTA ATORNILLAR

Screwdriver Bit
Embout vissage

∅	HEX 3	HEX 4	HEX 5	PH 1	PH 2	PH 3
Pcs	5	5	5	5	5	5
Ref. 1520	PZ 1	PZ 2	PZ 3	SL 4,5	SL 5,5	SL 6,5
L25 Pcs	5	5	5	5	5	5
∅	T 10	T 15	T 20	T 25	T 30	T 40
Pcs	5	5	5	5	5	5
Ref. 1520	PH 1	PH 2	PH 3	PZ 1	PZ 2	PZ 3
L50 Pcs	3	3	3	3	3	3
∅	SL 4,5	SL 5,5	SL 6,5	T 25	T 30	T 40
Pcs	3	3	3	3	3	3

Ref. 4995 - N° Art. 37502: 348,79 €

Display 71



PUNTA ATORNILLAR

Screwdriver Bit
Embout vissage

New!

	PZ 1	PZ 1	PH 1	PH 1	TX 10	TX 10	TX 15	TX 15	HEX 3	SL 4,5x0,6	
L	25 mm	50 mm	25 mm	50 mm	25 mm	50 mm	25 mm	50 mm	25 mm	25 mm	
Pcs	5	5	5	5	5	5	5	5	5	5	
	PZ 2	PZ 2	PH 2	PH 2	TX 20	TX 20	TX 25	TX 25	HEX 4	SL 5,5x0,8	
L	25mm	50mm	25mm	50mm	25mm	50mm	25mm	50mm	25mm	25mm	
Pcs	5	5	5	5	5	5	5	5	5	5	
	PZ 3	PZ 3	PH 3	PH 3	TX 30	TX 30	TX 40	TX 40	HEX 5	SL 6,5x1,2	
L	25mm	50mm	25mm	50mm	25mm	50mm	25mm	50mm	25mm	25mm	
Pcs	5	5	5	5	5	5	5	5	5	5	
Pcs	SET			SET			SET		Quick-lock INOX	Magnético IND	Magnético IND
	3			3			3		3	3	3

Ref. 4995 - N° Art. 83801: 379,53 €

New!



Set 13 Pcs

Cont.	N° Art.	€
PH: 1 - 2 - 3 +	83769	11,52
PZ: 1 - 2 - 3 +		
T: 10 - 15 - 20 - 25 - 30 - 40		

Box-Pallet 1520

12 Sets

N° Art.	€
83770	131,33

New!



Sets
1520

PUNTA ATORNILLAR

Screwdriver Bit
Embout vissage



Tipo
Type **PH-PZ-SL**

Set 12 Pcs

D mm	L mm	DIN	Nº Art.	€
PH: 1 - 2 (2 pcs.) - 3 +	25	C 6.3	33754	10,47
PZ: 1 - 2 (2 pcs.) - 3 +				
SL: 4,5x0,6 - 5,5x0,8 - 6,5-1,2				

Hasta fin de existencias - While stock lasts - Jusqu'à la fin de stock

Box-Pallet
1520

6 Sets

Nº Art.	€
68168	92,32



Set 31 Pcs

Nº Art.	€
67769	16,16

31
pcs

PH	d mm: 6,35
2x PH1	
3x PH2	
1x PH3	

PZ	d mm: 6,35
2x PZ1	
8x PZ2	
2x PZ3	

Tx	d mm: 6,35
1x T10	
2x T15	
2x T20	
3x T25	
3x T30	
1x T40	

Adapt. Quick-Lock
INOX/Stainless

L mm: 60 - d mm: 6,35



Ref. **1521**

PUNTA ATORNILLAR PRO

PRO Screwdriver Bit
Embout vissage PRO



Torsion
d = 6,35 mm

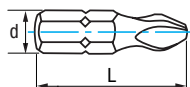

PHILLIPS



Tipo Type	D mm	L mm	DIN		Nº Art.	€ pack
PH	1	25	C 6.3	5	33173	3,52
PH	1	50	E 6.3	3	33192	6,49
PH	2	25	C 6.3	5	33174	3,52
PH	2	50	E 6.3	3	33193	6,49
PH	3	25	C 6.3	5	33175	3,52
PH	3	50	E 6.3	3	33194	6,49

POZIDRIVE



Tipo Type	D mm	L mm	DIN		Nº Art.	€ pack
PZ	1	25	C 6.3	5	33176	3,52
PZ	1	50	E 6.3	3	33195	6,49
PZ	2	25	C 6.3	5	33177	3,52
PZ	2	50	E 6.3	3	33196	6,49
PZ	3	25	C 6.3	5	33178	3,52
PZ	3	50	E 6.3	3	33197	6,49

PLANA / Flat / Plate



Tipo Type	D mm	L mm	DIN		Nº Art.	€ pack
SL	4,5x0,6	25	C 6.3	5	33186	6,04
SL	4,5x0,6	50	E 6.3	3	33204	8,40
SL	5,5x0,8	25	C 6.3	5	33187	6,04
SL	5,5x0,8	50	E 6.3	3	33205	8,40
SL	6,5x1,2	25	C 6.3	5	33188	6,04
SL	6,5x1,2	50	E 6.3	3	33206	8,40

TORX



Tipo Type	D mm	L mm	DIN		Nº Art.	€ pack
Tx	8	25	C 6.3	5	66725	5,69
Tx	10	25	C 6.3	5	33179	5,69
Tx	10	50	E 6.3	3	33198	8,05
Tx	15	25	C 6.3	5	33180	5,69
Tx	15	50	E 6.3	3	33199	8,05
Tx	20	25	C 6.3	5	33181	5,69
Tx	20	50	E 6.3	3	33200	8,05
Tx	25	25	C 6.3	5	33182	5,69
Tx	25	50	E 6.3	3	33201	8,05
Tx	27	25	C 6.3	5	33183	5,69
Tx	27	50	E 6.3	3	34144	8,05
Tx	30	25	C 6.3	5	33184	5,69
Tx	30	50	E 6.3	3	33202	8,05
Tx	40	25	C 6.3	5	33185	5,69
Tx	40	50	E 6.3	3	33203	8,05

Sets 1521



Tipo Type **Tx**

Set 7 Pcs

D mm	L mm	DIN	Nº Art.	€
10-15-20-25-30-40	25	C 6.3	33758	12,31

Hasta fin de existencias
While stock lasts
Jusqu'à la fin de stock

Ref. **1522**

PUNTA ATORNILLAR SUPERIOR

Superior Screwdriver Bit
Embout vissage supérieur

Zirkonio

d =
6,35 mm

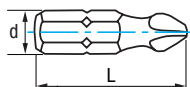

PHILLIPS



Tipo Type	D mm	L mm	DIN	Icon	Nº Art.	€ pack
PH 1	1	25	C 6.3	5	33207	7,52
PH 3	3	25	C 6.3	5	33209	7,52

POZIDRIVE



PZ	1	25	C 6.3	5	33210	7,52
----	---	----	-------	---	-------	------

PLANA / Flat / Plate



SL	5,5x0,8	25	C 6.3	5	33221	10,01
SL	6,5x1,2	25	C 6.3	5	33222	10,01

TORX



Tx	10	25	C 6.3	5	33213	9,83
Tx	15	25	C 6.3	5	33214	9,83
Tx	27	25	C 6.3	5	33217	9,83
Tx	30	25	C 6.3	5	33218	9,83
Tx	40	25	C 6.3	5	33219	9,83

Ref. 1522

Hasta fin de existencias
While stock lasts
Jusqu'à la fin de stock

Ref. **1523**

PUNTA ATORNILLAR IMPACTO MANGO E6.3

Impact Screwdriver Bit E6.3 Shank
Embout visage Impact queue E6.3

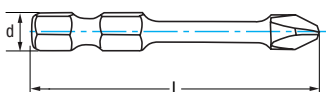

S2
material

60
HRC

d =
6,35 mm



New!



- Larga vida útil
- Soporta grandes pares de torsión
- Óptimo acople entre la punta y la cabeza del tornillo
- Long life
- Suitable for high-torque
- Optimal fit between the tip and the screw head
- Longue durée de vie
- Supporte de grands couples de torsion
- Adaptation optimale entre la pointe et la tête de la vis

PHILLIPS



Tipo Type	L mm	DIN	Torque (Nm)	Icon	Nº Art.	€ pack
PH 1	50	E 6.3	5,00	2	58907	2,97
PH 2	50	E 6.3	14,00	2	22807	2,97
PH 3	50	E 6.3	33,60	2	22816	2,97

POZIDRIVE



PZ 1	50	E 6.3	5,00	2	58910	2,97
PZ 2	50	E 6.3	14,00	2	22818	2,97
PZ 3	50	E 6.3	29,40	2	22820	2,97

TORX



TX 20	50	E 6.3	12,70	2	22836	3,68
TX 25	50	E 6.3	19,00	2	22839	3,68
TX 30	50	E 6.3	37,40	2	22843	3,68
TX 40	50	E 6.3	65,10	2	22845	3,68



Ref. **1524**

PUNTA ATORNILLAR EXTRA LARGA

Extra Long Screwdriver Bit
Embout vissage extra-long

New!

Standard

d =
6,35 mm

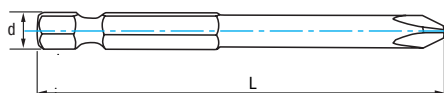

1
Uds



5
Uds

Tipo Type	D mm	L mm	DIN	Nº Art.	€ pack	Nº Art.	€ pack
--------------	---------	---------	-----	------------	-----------	------------	-----------

PHILLIPS



PH	1	75	E 6.3	23222	1,46	23225	6,20
PH	2	75	E 6.3	23270	1,46	23271	6,20
PH	3	75	E 6.3	23278	1,46	23279	6,20
PH	1	100	E 6.3	23227	1,67	23229	7,10
PH	2	100	E 6.3	23274	1,67	23275	7,10
PH	3	100	E 6.3	23280	1,67	23281	7,10
PH	1	150	E 6.3	23230	2,35	23231	10,00
PH	2	150	E 6.3	23276	2,35	23277	10,00
PH	3	150	E 6.3	23282	2,35	23283	10,00

POZIDRIVE



PZ	1	75	E 6.3	23284	1,46	23285	6,20
PZ	2	75	E 6.3	23290	1,46	23291	6,20
PZ	3	75	E 6.3	23296	1,46	23297	6,20
PZ	1	100	E 6.3	23286	1,67	23287	7,10
PZ	2	100	E 6.3	23292	1,67	23293	7,10
PZ	3	100	E 6.3	23298	1,67	23299	7,10
PZ	1	150	E 6.3	23288	2,35	23289	10,00
PZ	2	150	E 6.3	23294	2,35	23295	10,00
PZ	3	150	E 6.3	23300	2,35	23301	10,00

TORX



Tx	10	75	E 6.3	23330	1,54	23333	6,55
Tx	15	75	E 6.3	23342	1,54	23351	6,55
Tx	20	75	E 6.3	23359	1,54	23360	6,55
Tx	25	75	E 6.3	23366	1,54	23367	6,55
Tx	27	75	E 6.3	23384	1,54	23387	6,55
Tx	30	75	E 6.3	23395	1,54	23398	6,55
Tx	40	75	E 6.3	23408	1,54	23409	6,55
Tx	10	100	E 6.3	23334	1,76	23338	7,50
Tx	15	100	E 6.3	23352	1,76	23353	7,50
Tx	20	100	E 6.3	23361	1,76	23362	7,50
Tx	25	100	E 6.3	23374	1,76	23376	7,50
Tx	27	100	E 6.3	23388	1,76	23390	7,50
Tx	30	100	E 6.3	23399	1,76	23400	7,50
Tx	40	100	E 6.3	23410	1,76	23411	7,50
Tx	10	150	E 6.3	23339	2,46	23340	10,45
Tx	15	150	E 6.3	23355	2,46	23357	10,45
Tx	20	150	E 6.3	23364	2,46	23365	10,45
Tx	25	150	E 6.3	23382	2,46	23383	10,45
Tx	27	150	E 6.3	23392	2,46	23393	10,45
Tx	30	150	E 6.3	23404	2,46	23405	10,45
Tx	40	150	E 6.3	23414	2,46	23417	10,45

Display box

1510

SET PUNTAS DE PRECIÓN

Precision Screw Bit Set

Set embouts vissage de précision

New!



6 Sets

Nº Art. €

21335 148,81

58

pcs

Set 58 Pcs

Nº Art. €

21334 26,04



48 Puntas / Bits / Embouts material S2

PH	1.0 - 1.5 - 2.0 - 2.5 - 3.0 - 3.5
HEX	0.9 - 1.3 - 1.5 - 2.0 - 2.5 - 3.0 - 3.5 - 4.0 - 4.5 - 5.0 - 6.0
TS	2 - 3 - 4 - 5 - 6 - 7 - 8 - 9 - 10 - 15 - 20
SL	1.0 - 1.5 - 2.0 - 2.5 - 3.0 - 3.5
P	0.8 - 1.2 - 1.5 - 2.0
Y	0.8 - 2.0 - 2.5 - 3.0
1.5	
SQ	0 - 1 - 2
TA	2.0 - 2.3

6 Vasos / Sockets / Douilles hex. material CrV

M2.5 - M3.0 - M3.5 - M4.0 - M4.5 - M5.0

2 Adaptadores / Adaptors / Adaptateurs

H4.0 → H6.3 H6.3 → H4.0

Destornillador Profesional Aleación de Aluminio

1 Professional Aluminum Alloy Screwdriver
Tournevis en alliage aluminium

Alargador Flexible

1 Flexible Extension Bar
Rallonge Souple

PUNTAS DE GRADO INDUSTRIAL

- Acero S2 de gran dureza (60 HRC)
- Cuellos largos para un mejor acceso
- Magnéticos

INDUSTRIAL GRADE SCREW BITS

- Shock-resisting S2 Steel (60 HRC)
- Long neck. Suitable for hard-to-reach areas
- Magnetic

EMBOUTS À DEGRÉ INDUSTRIEL

- Acier S2 de grande dureté (60 HRC)
- Cous longs pour un meilleur accès
- Magnétiques

Ref. 1527

TOPE PROFUNDIDAD PLADUR

Plasterboard Depth Stop

Butée profondeur Placoplâtre



Tipo Type	D mm	L mm	DIN	📦	Nº Art.	€ pack
PH	2	25	C 6.3	2	77339	3,59
PH	2	50	E 6.3	2	74858	4,48
PZ	2	25	C 6.3	2	81588	3,59
PZ	2	50	E 6.3	2	81589	4,48



Set 4 Pcs

Cont.	Nº Art.	€
PH2 - L25 PH2 - L50 PZ2 - L25 PZ2 - L50	81594	8,09

Ref. **1529**

ADAPTADORES PUNTAS ATORNILLAR

Screwdriver Bit Adaptors
Adaptateurs embouts vissage



Tipo Type	L mm	d mm		Nº Art.	€ pack
Quick Lock INOX / Stainless	60	6,35	1	82687	8,48



Tipo Type	L mm	d mm		Nº Art.	€ pack
Quick Lock	60	6,35	1	33746	7,07



Tipo Type	L mm	d mm		Nº Art.	€ pack
SDS plus	78	6,35	1	33745	19,06



Tipo Type	L mm	d mm		Nº Art.	€ pack
Magnético IND	60	6,35	1	33747	3,52

Adaptador Magnético para Tornillos
Magnetic Screw Adaptor
Adaptateur magnetique pour vis



Tipo Type	mm	L mm	d mm		Nº Art.	€
Adapt.	6	65	6,35	1	42466	3,66
Adapt.	7	65	6,35	1	42472	3,66
Adapt.	8	65	6,35	1	42475	3,66
Adapt.	10	65	6,35	1	42478	3,89
Adapt.	12	65	6,35	1	42481	3,89
Adapt.	13	65	6,35	1	42483	3,89

* Interno / Internal / Intérieur

New!

Adaptador de 1/4 a 1/2
1/4 to 1/2 Adaptor
Adaptateur de 1/4 à 1/2

Para uso de herramientas de mango E6.3(1/4)
en llaves de impacto 1/2

It allows the use of E6.3(1/4) shank tools on a 1/2 Impact wrench

Pour utiliser des outils à queue hexagonale E6.3(1/4)
avec clés à choc de 1/2



mm	L mm	d mm		Nº Art.	€ pack
12,7	50	6,35	1	75107	7,36



Set **1529**

Adaptador Magnético para Tornillos
Magnetic Screw Adaptor
Adaptateur magnetique pour vis

5 Pcs

D mm	L mm	d mm		Nº Art.	€
6-7-8-10-13	65	6,35	5	69751	18,72

Ref. **3407**

EXTRACTORES IMPACTO

Impact Extractor
Extracteurs impact

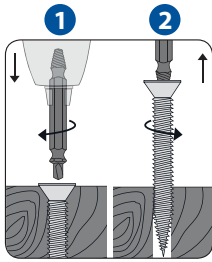

1. Taladrar el tornillo
2. Dar la vuelta y extraer

1. Drill the screw
2. Turn over and remove

1. Percer la vis
2. Retourner et retirez

Mod.	Cap. (mm)	Nº Art.	€
Nº 1	3-5	14953	6,32
Nº 2	4-8	14955	6,32
Nº 3	5-10	14956	6,32
* Nº 4	6-12	14958	6,32

- * Nº4 no es válido para atornillador de impacto
- * Nº4 is not suitable for impact drivers
- * Nº4 n'est pas valide pour les visseuses impact



Set 17 Pcs

Nº Art.	€
72898	25,29



17
pcs

Extractores Impacto
Impact Extractors
Extracteurs impact
N.º 1 - 2 - 3 - 4

PH d mm: 6,35
PH1
PH2
PH3
L mm: 25

PZ d mm: 6,35
PZ1
PZ2
PZ3
L mm: 25

d mm: 6,35
Tx
T10
T15
T20
T25
T30
T40
L mm: 25

Adapt. Quick-Lock
L mm: 60 - d mm: 6,35



Box-Pallet
3407

6 Sets

Nº Art.	€
74792	144,53

Ref. **1461**

SET BROCAS Y PUNTAS ATORNILLAR

Drill Bit & Screwdriver Bit Set
Jeu de forets et embouts vissage



72

pcs

Brocas Metal
Metal Drill Bits
Forets Métal

2 - 3 - 4 - 5 - 6 - 8 mm

Brocas Pared
Masonry Drill Bits
Forets Maçonnerie

4 - 5 - 6 - 8 mm

Brocas Madera
Wood Drill Bits
Forets Bois

3 - 4 - 5 - 6 - 8 mm

Adapt. Magnético
Magnetic Adapt.
Adapt. Magnétique

6 - 7 - 8
10 - 13 mm

Adapt. Quick-Lock
INOX/Stainless

L mm: 60 - d mm: 6,35
1 pc.

Cuter Hoja Partible
Snap-Off Box Cutter
Couteaux à lames rétractables

1 pc.

Puntas Atornillar / Screwdriver Bits / Embouts Vissage

PH d mm: 6,35
3x PH1
4x PH2
3x PH3
← 25 mm →

PZ d mm: 6,35
3x PZ1
4x PZ2
2x PZ3
← 25 mm →

d mm: 6,35
T5 - T6
2x T10
T15
3x T20
4x T25
T27
3x T30
2x T40
← 25 mm →

d mm: 6,35
SL SL 4
SL 4,5
SL 5,5
SL 6
SL 6,5
← 25 mm →

d mm: 6,35
SQ SQ 1
SQ 2
SQ 3
← 25 mm →

d mm: 6,35
HEX H2
H3
H4
H5
H6
← 25 mm →

Nº Art. €
78504 57,14



DOBLE BLISTER

Double Blister

Double blister

METAL

Metal
Métal

370

CONSTRUCCIÓN

Construction
Construction

374

MADERA

Wood
Bois

379



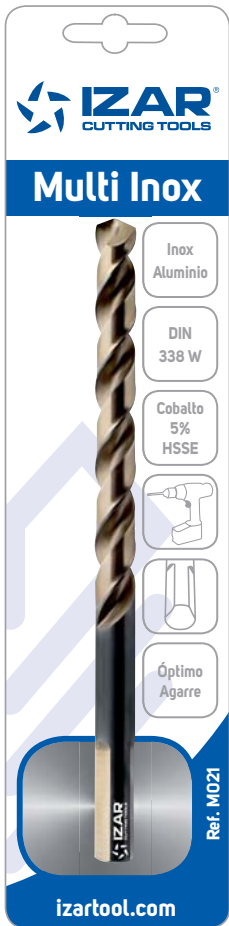

BROCA UNIVERSAL COBALTO MULTI INOX
Multi-STAINLESS Cobalt Universal Drill Bit
Foret universel Cobalt Multi INOX

Ref. **M021**

INOX
Stainless Steel

Aluminio
Aluminium

DIN 338 W Cobalto 5% HSSE

Óptimo Agarre
Optimum fixing
Fixation optimale

D mm	L mm	I mm		Nº Art.	€
1,00	34	12	2	67643	6,59 *
1,50	40	18	2	67644	6,26 *
2,00	49	24	2	67645	6,26 *
2,50	57	30	2	67646	5,70 *
3,00	61	33	2	67647	5,58 *
3,25	65	36	2	67648	6,59 *
3,50	70	39	2	67650	6,52 *
4,00	75	43	2	67651	7,01 *
4,25	75	43	1	67652	3,92
4,50	80	47	1	67653	3,92
5,00	86	52	1	67654	4,20
5,50	93	57	1	67655	5,31
6,00	93	57	1	67656	5,65
6,50	101	63	1	67657	6,38
7,00	109	69	1	67658	6,95
7,50	109	69	1	67659	7,42
8,00	117	75	1	67660	8,68
8,50	117	75	1	67661	9,05
9,00	125	81	1	67662	11,54
10,00	133	87	1	67663	12,82
11,00	142	94	1	67664	19,05
12,00	151	101	1	67665	23,52
13,00	151	101	1	67666	26,56



* € = 2 uds.

Línea 1m M021

BROCA UNIVERSAL COBALTO MULTI INOX
Multi-STAINLESS Cobalt Universal Drill Bit
Foret universel Cobalt Multi INOX



∅	2	2,5	3	3,25	3,5	4	4,25	4,5	5	5,5	6	6,5	7	7,5	8	8,5	9	10	12
Pcs	5	5	5	5	5	5	5	5	5	5	5	5	5	5	5	5	5	5	5

Ref. 4995 - Nº Art. 70995: **735,26 €**

Sets
BROCA UNIVERSAL COBALTO MULTI INOX
Multi-STAINLESS Cobalt Universal Drill Bit
Foret Universel Cobalt Multi INOX



6 Pcs

∅ mm	Nº Art.	€
2-8	34204	23,71



19 Pcs

∅ mm	Nº Art.	€
1-10 x0,50	34201	98,64



BROCA MANGO CILÍNDRICO COBALTO INOX
STAINLESS Cobalt Straight Shank Drill Bit
 Foret queue cylindrique Cobalt INOX

Ref. **M020** Onix M102



INOX
Stainless Steel

Aluminio
Aluminium

DIN 338 W

Cobalto 5% HSSE

DIN 338 W

Cobalto 5% HSSE

D mm	L mm	l mm		Nº Art.	€
1,00	34	12	2	68049	4,90 *
1,50	40	18	2	68050	4,70 *
2,00	49	24	2	68052	4,70 *
2,50	57	30	2	68053	4,32 *
3,00	61	33	2	68054	4,23 *
3,25	65	36	2	68055	5,02 *
3,50	70	39	2	68056	4,94 *
4,00	75	43	2	68057	5,31 *
4,25	75	43	1	68058	2,97
4,50	80	47	1	68060	2,97
5,00	86	52	1	68061	3,19
5,50	93	57	1	68062	4,02
6,00	93	57	1	68063	4,28
6,50	101	63	1	68064	4,83
7,00	109	69	1	68065	5,28
7,50	109	69	1	68066	5,62
8,00	117	75	1	68067	6,56
8,50	117	75	1	68068	6,87
9,00	125	81	1	68069	8,75
10,00	133	87	1	68070	9,72
11,00	142	94	1	68071	14,44
12,00	151	101	1	68072	17,84
13,00	151	101	1	68073	20,16



* € = 2 uds.

Línea 1m M020

BROCA MANGO CILÍNDRICO COBALTO INOX
STAINLESS Cobalt Straight Shank Drill Bit
 Foret queue cylindrique Cobalt INOX



∅	2	2,5	3	3,25	3,5	4	4,25	4,5	5	5,5	6	6,5	7	7,5	8	8,5	9	10	12
Pcs	5	5	5	5	5	5	5	5	5	5	5	5	5	5	5	5	5	5	5

Ref. 4995 - Nº Art. 71036: 557,05 €

Sets
BROCA MANGO CILÍNDRICO COBALTO INOX
STAINLESS Cobalt Straight Shank Drill Bit
 Foret queue cylindrique Cobalt INOX



6 Pcs

∅ mm	Nº Art.	€
2-8	25367	19,16



19 Pcs

∅ mm	Nº Art.	€
1-10 x0,50	24636	79,51



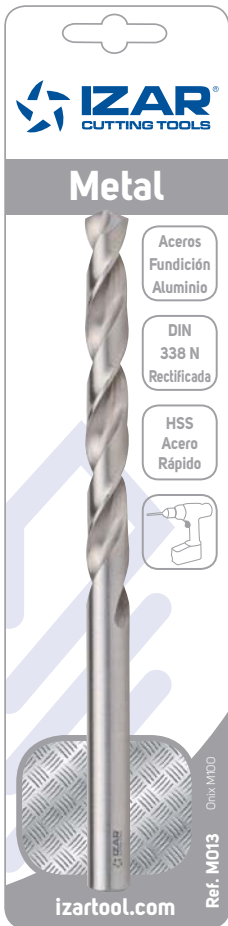

BROCA MANGO CILÍNDRICO HSS SPEED POINT
Speed Point HSS Straight Shank Drill Bit
Foret queue cylindrique HSS Speed Point

Ref. **M013** Onix M100



Fundición
Cast Iron
Fonte

Aluminio
Aluminium

DIN 338 N Rectificada

HSS Acero Rápido



D mm	L mm	I mm		Nº Art.	€
1,00	34	12	2	67996	2,76
1,50	40	18	2	67998	2,06
2,00	49	24	2	67999	1,95
2,50	57	30	2	68001	2,11
3,00	61	33	2	68002	1,88
3,25	65	36	2	68004	2,14
3,50	70	39	2	68005	2,11
4,00	75	43	2	68007	2,36
4,25	75	43	1	68008	1,31
4,50	80	47	1	68010	1,36
5,00	86	52	1	68011	1,54
5,50	93	57	1	68013	1,96
6,00	93	57	1	68014	2,01
6,50	101	63	1	68015	2,26
7,00	109	69	1	68016	2,76
7,50	109	69	1	68017	2,87
8,00	117	75	1	68018	3,31
8,50	117	75	1	68019	3,57
9,00	125	81	1	68020	4,36
10,00	133	87	1	68021	4,94
11,00	142	94	1	68022	6,86
12,00	151	101	1	68023	8,16
13,00	151	101	1	68025	9,29



* € = 2 uds.

Línea 1m M013

BROCA MANGO CILÍNDRICO HSS SPEED POINT
Speed Point HSS Straight Shank Drill Bit
Foret queue cylindrique HSS Speed Point



∅	2	2,5	3	3,25	3,5	4	4,25	4,5	5	5,5	6	6,5	7	7,5	8	8,5	9	10	12
Pcs	5	5	5	5	5	5	5	5	5	5	5	5	5	5	5	5	5	5	5

Ref. 4995 - Nº Art. 71045: 264,74 €

Sets **BROCA MANGO CILÍNDRICO HSS SPEED POINT**
Speed Point HSS Straight Shank Drill Bit
Foret queue cylindrique HSS Speed Point



6 Pcs

∅ mm	Nº Art.	€
2-8	25365	8,88



19 Pcs

∅ mm	Nº Art.	€
1-10 x0,50	18808	38,05



BROCA MANGO REBAJADO HSS
 HSS Reduced Shank Drill Bit
 Foret queue réduit HSS

Ref. **M007** Onix M101



Fundición
 Cast Iron
 Fonte

Aluminio
 Aluminium

12,7 mm
 HSS

DIN 338 N
 Rectificada

D mm	L mm	I mm		Nº Art.	€
12,00	151	101	1	68026	9,17
12,50	151	101	1	68028	9,94
13,00	151	101	1	68029	10,22
13,50	160	108	1	68031	13,81
14,00	160	108	1	68032	14,66
14,50	169	114	1	68034	15,65
15,00	169	114	1	68035	15,83
15,50	178	120	1	68036	18,24
16,00	178	120	1	68037	18,92
16,50	184	125	1	68038	21,22
17,00	184	125	1	68039	21,22
17,50	191	130	1	68040	24,15
18,00	191	130	1	68041	25,42
18,50	198	135	1	68043	28,05
19,00	198	135	1	68044	28,05
19,50	204	140	1	68046	30,56
20,00	205	140	1	68047	35,20



Línea 1m
M007

BROCA MANGO REBAJADO HSS
 HSS Reduced Shank Drill Bit
 Foret queue réduit HSS

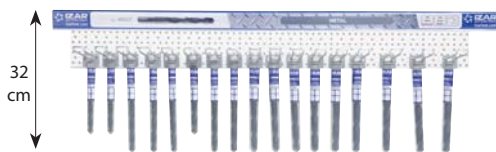

∅	12	12,5	13	13,5	14	14,5	15	15,5	16	16,5	17	17,5	18	18,5	19	19,5	20
Pcs	2	2	2	2	2	2	2	2	2	2	2	2	2	2	2	2	2

Ref. 4995 - Nº Art. 71049: 680,58 €



BROCA-MARTILLO SDS PLUS
 SDS plus Rotary Hammer Drill Bit
 Foret percussion SDS plus

Ref. **M890** Onix M304



Hormigón bloque
 Concrete Block
 Parpaing
Ladrillo
 Brick
 Brique
Cemento
 Cement
 Ciment



D mm	L mm	l mm		Nº Art.	€
04,00	110	50	1	67962	4,27
05,00	110	50	1	67963	3,11
05,00	160	100	1	67964	4,04
06,00	110	50	1	67965	3,18
06,00	160	100	1	67966	3,67
06,00	210	150	1	67967	6,07
06,00	260	200	1	67968	7,82
08,00	110	50	1	67969	4,03
08,00	160	100	1	67970	3,85
08,00	210	150	1	67971	5,50
08,00	260	200	1	67972	7,79
10,00	110	50	1	67973	4,60
10,00	160	100	1	67974	5,15
10,00	210	150	1	67975	6,19
10,00	260	200	1	67976	9,12
12,00	160	100	1	67977	5,47
12,00	210	150	1	67978	6,93
12,00	260	200	1	67979	9,85
14,00	160	100	1	67980	7,53
14,00	210	150	1	67981	10,98
16,00	160	100	1	67982	10,45
16,00	210	150	1	67983	12,74
16,00	260	200	1	67984	13,75
16,00	310	250	1	67986	14,70



Línea 1m
M890

BROCA-MARTILLO SDS PLUS
 SDS plus Rotary Hammer Drill Bit
 Foret percussion SDS plus



Ø	4	5	6	8	10	5	6	8	10	12	14	16	8	10	12	14	16
Ø	L110	L110	L110	L110	L110	L160	L160	L160	L160	L160	L160	L160	L210	L210	L210	L210	L210
Pcs	5	5	5	5	5	5	5	5	5	5	5	5	5	5	5	5	5

Ref. 4995 - Nº Art. 71056: 508,46 €

Línea 33 cm
M890

BROCA-MARTILLO SDS PLUS
 SDS plus Rotary Hammer Drill Bit
 Foret percussion SDS plus



Ø	6	8	10	12	16	16
Ø	L260	L260	L260	L260	L260	L310
Pcs	5	5	5	5	2	2

Ref. 4995 - Nº Art. 71059: 229,73 €

BROCA PORCELÁNICO
PORCELAIN Drill Bit
 Foret PORCELAINE

Ref. **M882** Onix M302

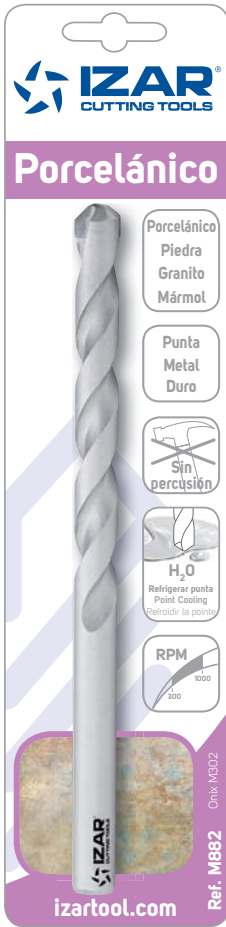

Porcelánico
 Porcelain
 Porcelaine

Piedra
 Stone
 Pierre

Granito
 Granite

Mármol
 Marble
 Marbre



D mm	L mm	l mm	📦	Nº Art.	€
3,00	85	42	1	67944	13,70
3,50	85	42	1	67945	13,70
4,00	85	50	1	67946	13,70
4,50	85	50	1	67947	13,70
5,00	85	50	1	67948	14,50
6,00	100	65	1	67950	15,18
7,00	125	75	1	67951	17,34
8,00	125	75	1	67952	18,78
9,00	150	90	1	67953	22,79
10,00	150	90	1	67954	22,79
11,00	150	90	1	67955	29,57



Línea 1m
M882

BROCA PORCELÁNICO
PORCELAIN Drill Bit
 Foret PORCELAINE



ø	3	3,5	4	4,5	5	6	7	8	9	10	11
Pcs	4	2	4	2	5	5	4	2	4	4	2

Ref. 4995 - Nº Art. 71067: 661,16 €



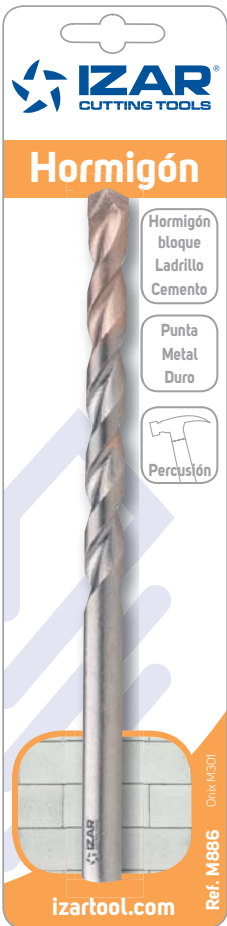

BROCA PUNTA METAL DURO PARED PROFESIONAL

Professional Concrete Carbide Tipped Drill Bit

Foret pointe carbure Béton Professionnel

Ref. **M886** Onix M301



Hormigón bloque
Concrete Block
Parpaing
Ladrillo
Brick
Brique
Cemento
Cement
Ciment



D mm	L mm	l mm		Nº Art.	€
3,00	60	35	1	67926	2,06
4,00	75	45	1	67927	2,06
5,00	85	40	1	67928	2,09
6,00	100	55	1	67929	2,25
7,00	100	55	1	67930	2,70
8,00	120	70	1	67931	3,02
9,00	120	70	1	67932	3,77
10,00	120	70	1	67933	3,77
12,00	150	90	1	67934	5,67
14,00	150	90	1	67935	8,35
16,00	150	90	1	67936	15,22



Línea 1m M886

BROCA PUNTA METAL DURO PARED PROFESIONAL

Professional Concrete Carbide Tipped Drill Bit

Foret pointe carbure Béton Professionnel



∅	3	4	5	6	7	8	9	10	12	14	16
Pcs	10	10	10	10	10	10	10	10	10	10	10

Ref. 4995 - Nº Art. 71071: 509,66 €

Sets **BROCA PUNTA METAL DURO PARED PROFESIONAL**
Professional Concrete Carbide Tipped Drill Bit
Foret pointe carbure Béton Professionnel



5 Pcs

∅ mm	Nº Art.	€
4-10	30220	14,52



8 Pcs

∅ mm	Nº Art.	€
3-10	21653	23,86



BROCA PUNTA METAL DURO PARED STANDARD
 Standard MASONRY Carbide Tipped Drill Bit
 Foret pointe carbure MAÇONNERIE Standard

Ref. **M880** Onix M300



D mm	L mm	l mm	📦	Nº Art.	€
3,00	60	30	1	67914	1,00
4,00	75	40	1	67916	1,05
5,00	85	50	1	67918	1,14
6,00	100	60	1	67919	1,30
7,00	100	60	1	67920	1,47
8,00	120	80	1	67921	1,62
9,00	120	80	1	67922	1,83
10,00	120	80	1	67923	1,97
12,00	150	80	1	67924	2,83
14,00	150	95	1	67925	4,13



Línea 1m M880

BROCA PUNTA METAL DURO PARED STANDARD
 Standard MASONRY Carbide Tipped Drill Bit
 Foret pointe carbure MAÇONNERIE Standard

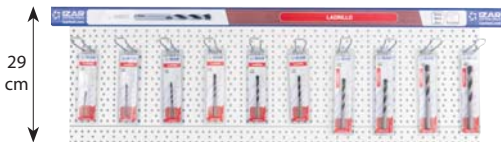

∅	3	4	5	6	7	8	9	10	12	14
Pcs	10	10	10	10	10	10	10	10	10	10

Ref. 4995 - Nº Art. 71078: 183,62 €

Sets
BROCA PUNTA METAL DURO PARED STANDARD
 Standard MASONRY Carbide Tipped Drill Bit
 Foret pointe carbure MAÇONNERIE Standard



5 Pcs

∅ mm	Nº Art.	€
4-10	30215	7,25



8 Pcs

∅ mm	Nº Art.	€
3-10	30219	10,84

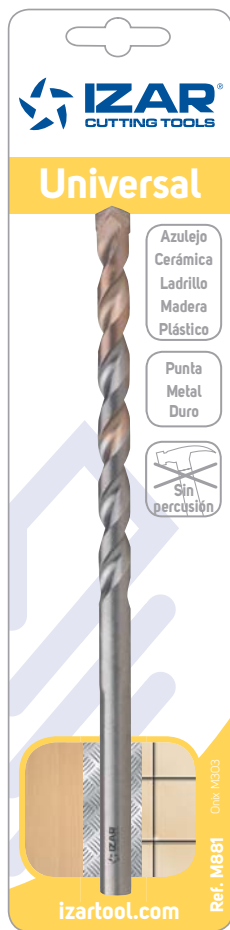

BROCA UNIVERSAL
UNIVERSAL Drill Bit
Foret UNIVERSEL

Ref. **M881** Onix M303



Azulejo
Tile
Carreau

Cerámica
Ceramics
Céramique

Ladrillo
Brick
Brique

Madera
Wood
Bois

Plástico
Plastics
Plastique

Punta MD/HM
Point



D mm	L mm	l mm		Nº Art.	€
4,00	103	50	1	67956	6,17
5,00	112	50	1	67957	5,67
6,00	123	60	1	67958	5,81
8,00	134	80	1	67959	6,76
10,00	135	80	1	67960	8,51
12,00	153	90	1	67961	10,75



Línea 33 cm
M881

BROCA UNIVERSAL
UNIVERSAL Drill Bit
Foret UNIVERSEL



ø	4	5	6	8	10	12
Pcs	5	5	5	5	5	5

Ref. 4995 - Nº Art. 71081: 218,31 €

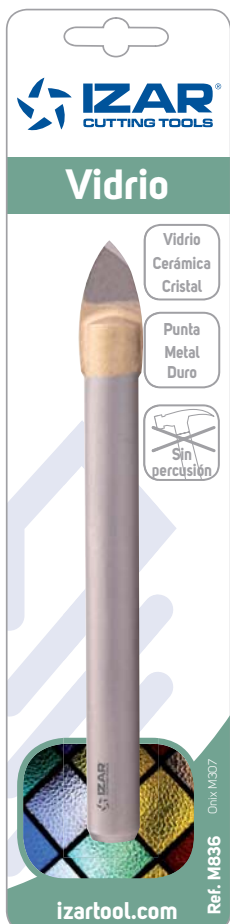

BROCA VIDRIO
GLASS Drill Bit
Foret VERRE

Ref. **M836** Onix M307



Vidrio
Glass
Verre

Cerámica
Ceramics
Céramique

Cristal
Crystal
Cristal

Punta MD/HM
Point



D mm	L mm		Nº Art.	€
3,00	58	1	67987	5,98
4,00	64	1	67989	6,55
5,00	70	1	67990	6,99
6,00	76	1	67992	7,38
8,00	83	1	67993	9,04
10,00	90	1	67995	12,66



Línea 33 cm
M836

BROCA VIDRIO
GLASS Drill Bit
Foret VERRE



ø	3	4	5	6	8	10
Pcs	5	5	5	5	5	5

Ref. 4995 - Nº Art. 71085: 242,94 €



BROCA PUNTA CENTRAR
Center Point Drill Bit
Foret auto-centreur

Ref. **M640** Onix M200



Madera
Wood
Bois
Aglomerado
Chipboard
Aggloméré

CRV

D mm	L mm	I mm		Nº Art.	€
3,00	61	33	1	68074	0,88
4,00	75	43	1	68076	0,89
5,00	86	52	1	68077	0,99
6,00	97	60	1	68078	1,20
7,00	109	69	1	68079	1,30
8,00	117	75	1	68080	1,64
9,00	125	80	1	68081	1,77
10,00	133	87	1	68082	1,88
11,00	142	89	1	68083	2,35
12,00	151	96	1	68084	2,59
13,00	191	96	1	68085	2,49
14,00	151	97	1	68086	2,71
15,00	160	100	1	68087	3,03
16,00	160	100	1	68088	3,46
18,00	180	120	1	68089	7,92
20,00	200	130	1	68090	9,64



Línea 1m
M640

BROCA PUNTA CENTRAR
Center Point Drill Bit
Foret auto-centreur



∅	3	4	5	6	7	8	9	10	11	12	13	14	15	16	18	20
Pcs	5	5	5	5	5	5	5	5	5	5	5	5	5	3	3	3

Ref. 4995 - Nº Art. 71092: 181,65 €

Sets

BROCA PUNTA CENTRAR
Center Point Drill Bit
Foret auto-centreur



5 Pcs

∅ mm	Nº Art.	€
4-10	30223	6,38



8 Pcs

∅ mm	Nº Art.	€
3-10	30226	9,59





BROCA PLANA
Flat Bit
Mèche plate

Ref. **M650** Onix M201



Madera
Wood
Bois
Aglomerado
Chipboard
Aggloméré



D mm	L mm	Icon	Nº Art.	€
6,00	160	1	68091	2,06
8,00	160	1	68092	2,06
10,00	160	1	68093	2,15
12,00	160	1	68094	2,36
14,00	160	1	68095	2,46
16,00	160	1	68096	2,59
18,00	160	1	68097	2,90
20,00	160	1	68098	2,90
22,00	160	1	68099	3,22
24,00	160	1	68100	3,46
25,00	160	1	68101	3,92
26,00	160	1	68102	4,12
28,00	160	1	68103	4,23
30,00	160	1	68104	4,47
32,00	160	1	68105	4,76
36,00	160	1	68106	5,53
38,00	160	1	68107	5,84



Línea 1m
M650

BROCA PLANA
Flat Bit
Mèche plate



ø	6	8	10	12	14	16	18	20	22	24	25	26	28	30	32	36	38	L305
Pcs	10	10	10	10	10	10	10	10	5	5	5	5	5	5	5	5	5	1

Ref. 4995 - Nº Art. 71088: 403,43 €





PRESENTACIONES

Presentations

Presentations

PRESENTACIÓN IZAR EN LÍNEA

IZAR Line Presentation

Presentation IZAR ligne

382

PRESENTACIÓN IZAR EN CASCADA

IZAR Cascade Presentation

Presentation IZAR cascade

390

EXPOSITORES APILABLES

Stacking Exhibitors

Présentoirs apilables

394



¡NUEVA IMPLANTACIÓN DOBLE BLISTER!

New Double Blister Stock Offer!

Nouveau implantation Double Blister!



¡NUEVA IMPLANTACIÓN DOBLE BLISTER!

New Double Blister Stock Offer!
Nouveau implantation Double Blister!

1m
M650 **BROCA PLANA**
Flat Bit
Meche plate

Ref. 4995 - Nº Art. 71088: **403,43 €**
>> Pag. 380

1m
M880 **BROCA PUNTA METAL DURO PARED STANDARD**
Standard MASONRY Carbide Tipped Drill Bit
Foret pointe carbure MAÇONNERIE standard

Ref. 4995 - Nº Art. 71078: **183,62 €**
>> Pag. 377

1m
M640 **BROCA PUNTA CENTRAR**
Center Point Drill Bit
Foret auto-centreur

Ref. 4995 - Nº Art. 71092: **181,65 €**
>> Pag. 379

33cm
M881 **BROCA UNIVERSAL**
UNIVERSAL Drill Bit
Foret UNIVERSEL

Ref. 4995 - Nº Art. 71081: **218,31 €**
>> Pag. 378

1m
M013 **BROCA MANGO CILÍNDRICO HSS SPEED POINT**
Speed Point HSS Straight Shank Drill Bit
Foret queue cylindrique HSS Speed Point

Ref. 4995 - Nº Art. 71045: **264,74 €**
>> Pag. 372

33cm
M836 **BROCA VIDRIO**
GLASS Drill Bit
Foret VERRE

Ref. 4995 - Nº Art. 71085: **242,94 €**
>> Pag. 378

1m
M021 **BROCA UNIVERSAL COBALTO MULTI INOX**
Multi-STAINLESS Cobalt Universal Drill Bit
Foret Universel cobalt Multi INOX

Ref. 4995 - Nº Art. 70995: **735,26 €**
>> Pag. 370

1m
M882 **BROCA PORCELÁNICO**
PORCELAIN Drill Bit
Foret PORCELAINE

Ref. 4995 - Nº Art. 71067: **661,16 €**
>> Pag. 375

1m
M020 **BROCA MANGO CILÍNDRICO COBALTO INOX**
STAINLESS Cobalt Straight Shank Drill Bit
Foret queue cylindrique Cobalt INOX

Ref. 4995 - Nº Art. 71036: **557,05 €**
>> Pag. 371

1m
M886 **BROCA PUNTA METAL DURO PARED PROFESIONAL**
Professional Concrete Carbide Tipped Drill Bit
Foret pointe carbure Béton Professionnel

Ref. 4995 - Nº Art. 71071: **509,66 €**
>> Pag. 376

1m
M007 **BROCA MANGO REBAJADO HSS**
HSS Reduced Shank Drill Bit
Foret queue reduit HSS

Ref. 4995 - Nº Art. 71049: **680,58 €**
>> Pag. 373

1m
M890 **BROCA-MARTILLO SDS PLUS**
SDS plus Rotary Hammer Drill Bit
Foret percussion SDS plus

Ref. 4995 - Nº Art. 71056: **508,46 €**
>> Pag. 374

33cm
M890 **BROCA-MARTILLO SDS PLUS**
SDS plus Rotary Hammer Drill Bit
Foret percussion SDS plus

Ref. 4995 - Nº Art. 71059: **229,73 €**
>> Pag. 374

33cm
1870 **CINCEL SDS PLUS**
SDS plus Chisel
Burin SDS plus

Ref. 4995 - Nº Art. 71023: **85,03 €**
>> Pag. 226



* Sets no incluidos / Sets not included / Jeux non inclus **TOTAL: 5.461,63 €**

Set
M013

METAL
Metal
Métal

Ø mm		Nº Art.	€
2-8	6	25365	8,88

Set
M880

PARED
Masonry
Maçonnerie

Ø mm		Nº Art.	€
4-10	5	30215	7,25

Sets
M640

MADERA
Wood
Bois

Ø mm		Nº Art.	€
4-10	5	30223	6,38

MADERA GRANDE
Wood Big
Bois large

Ø mm		Nº Art.	€
3-10	8	30226	9,59

¡NUEVA IMPLANTACIÓN LÍNEA!

New Line Stock Offer!

Nouveau implantation Ligne!

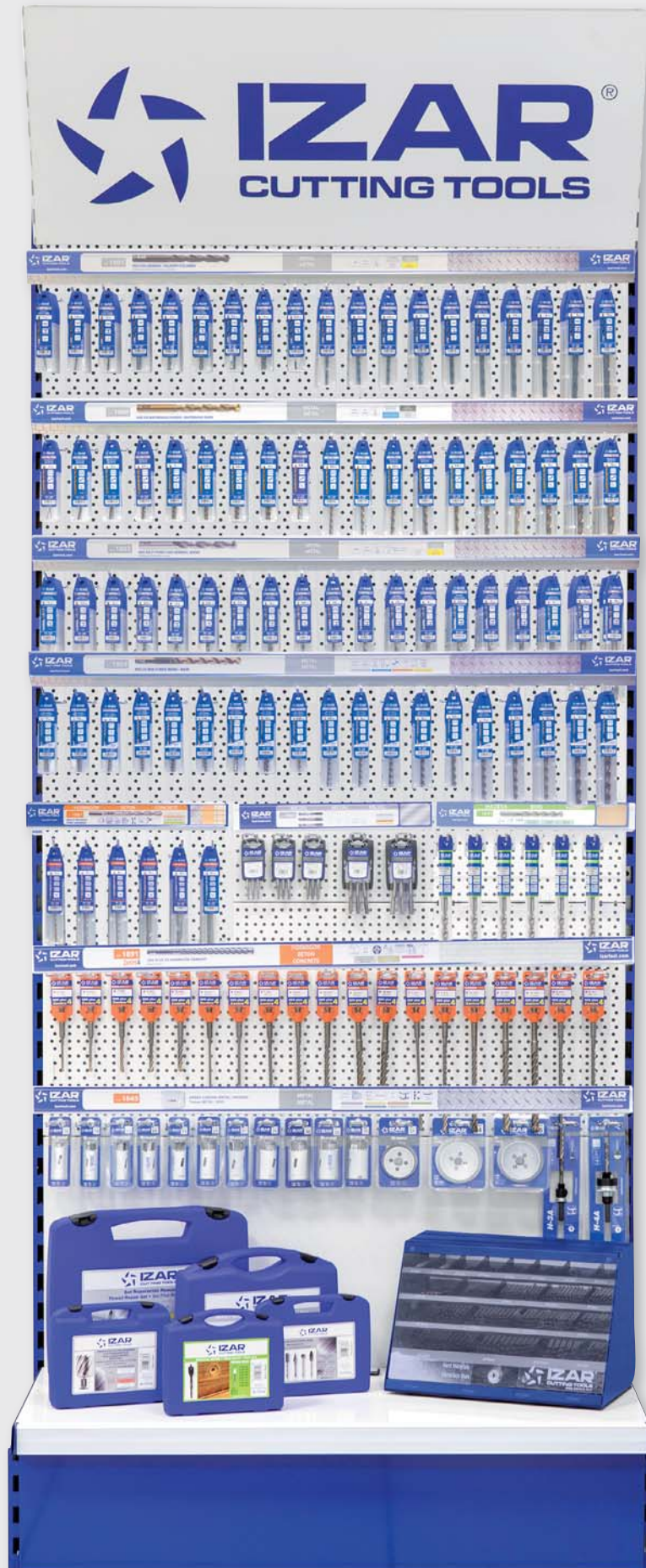

¡NUEVA IMPLANTACIÓN LÍNEA!

New Line Stock Offer!

Nouveau implantation Ligne!

1m
1001

BROCA MANGO CILÍNDRICO HSS

HSS Straight Shank Drill Bit
Foret queue cylindrique HSS

Ref. 4995 - Nº Art. 70942: **383,57 €** >> Pag. 51

1m
1006

BROCA MANGO CILÍNDRICO COBALTO

Cobalt Straight Shank Drill Bit
Foret queue cylindrique Cobalt

Ref. 4995 - Nº Art. 70936: **604,08 €** >> Pag. 27

1m
1002

BROCA MANGO CILÍNDRICO HSS SPEED POINT

Speed Point HSS Straight Shank Drill Bit
Foret queue cylindrique HSS Speed Point

Ref. 4995 - Nº Art. 70947: **421,84 €** >> Pag. 61

1m
1004

BROCA UNIVERSAL COBALTO **MULTI INOX**

Multi-STAINLESS Cobalt Universal Drill Bit
Foret universel Cobalt **Multi INOX**

Ref. 4995 - Nº Art. 70933: **599,74 €** >> Pag. 19

33cm
1881

BROCA UNIVERSAL

UNIVERSAL Drill Bit
Foret UNIVERSEL

Ref. 4995 - Nº Art. 71034: **209,22 €** >> Pag. 242

33cm
3003

JUEGO MACHOS MANO MÉTRICA

Metric Hand Tap Set
Jeu de tarauds à main métrique

Ref. 4995 - Nº Art. 70990: **340,59 €** >> Pag. 122

33cm
1641

BROCA PUNTA CENTRAR PRO

PRO Drill Bit
Foret auto-centreur PRO

Ref. 4995 - Nº Art. 71044: **115,81 €** >> Pag. 268

1m
1891

BROCA-MARTILLO SDS PLUS 4Z

4Z Cutter SDS plus Rotary Hammer Drill Bit
Foret percussion SDS plus 4Z

Ref. 4995 - Nº Art. 71015: **348,43 €** >> Pag. 211

1m
1645

SIERRA CORONA **METAL / MADERA**

METAL / WOOD Hole Saw
Trépan **MÉTAL / BOIS**

Ref. 4995 - Nº Art. 71040: **436,82 €** >> Pag. 248

TOTAL: 3.460,09 €

* **Maletines y Cabinet no incluidos**
Cases & Cabinet not included
Mallettes et Présentoir non inclus



ACCESORIOS LÍNEAS

Line Accessories
Accessoires ligne



Panel Inicial 1m

Initial Panel
Panneau initial

N° Art.	€
71120	669,29

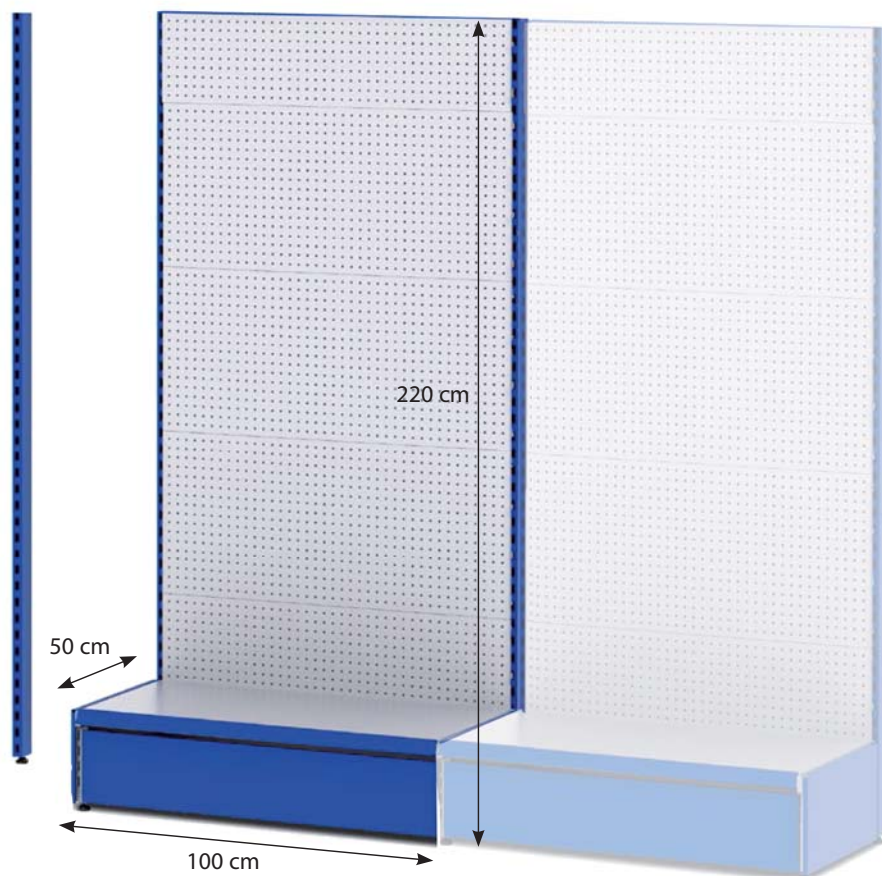

Panel Adicional 1m

Additional Panel
Panneau supplémentaire

N° Art.	€
71169	570,79

ACCESORIOS LÍNEAS

Line Accessories
Accessoires ligne

Copete Liso 1m
Straight Top
Panneau supérieur lisse



N° Art.	€
59996	94,83

Copete Curvo 1m
Curve Top
Panneau supérieur curbe



Mod.	N° Art.	€
Standard	71112	159,31
Standard + Led	71113	159,31



Cajonera zócalo 100x40
Drawer
Tiroir

N° Art.	€
71111	185,86



Balda
Shelf
Étagère

Mod.	N° Art.	€
100x30 cm	64056	48,94
100x40 cm	64057	48,94



Balda-Cesta 30x30
Basket-Shelf
Étagère-Panier

N° Art.	€
71124	26,54



Balda-Podium 30x30
Podium-Shelf
Étagère-Podium

N° Art.	€
71110	26,54

ACCESORIOS LÍNEAS

Line Accessories
Accessoires ligne

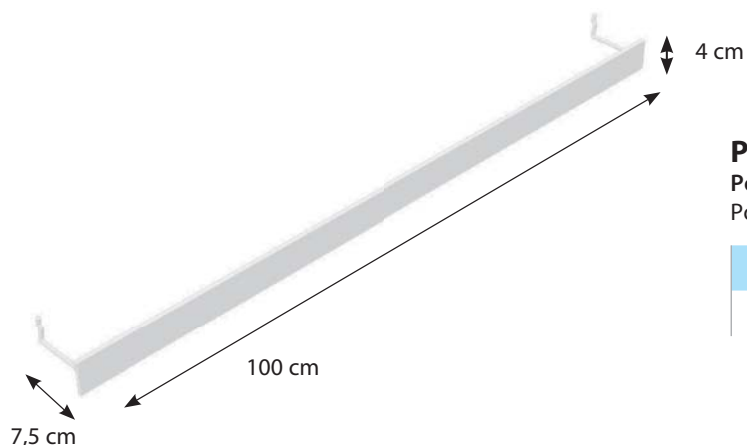

Porta-Cartel 1m

Poster-Holder
Porte-Affiche

N° Art.	€
69760	33,82

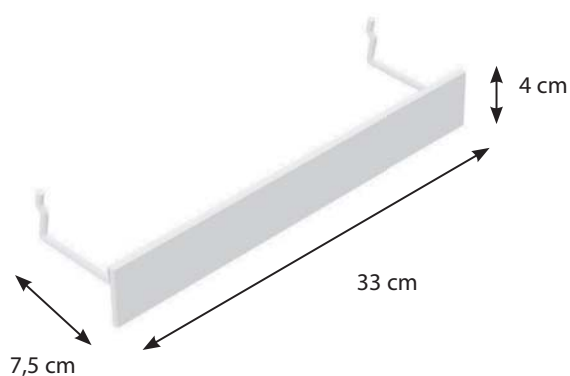

Porta-Cartel 33cm

Poster-Holder
Porte-Affiche

N° Art.	€
69781	18,39



Gancho simple

Simple Hook
Crochet simple

Mod.	N° Art.	€
4x100 mm	52956	0,56
4x150 mm	57810	0,75



Gancho doble

Double Hook
Crochet double

Mod.	N° Art.	€
4x150 mm	52957	1,12

ACCESORIOS LÍNEAS

Line Accessories
Accessoires ligne



1 Rail Rail / Raille

N° Art.	€
72270	2,39

3 Tope frontal / Front block Support adhésif frontal

N° Art.	€
71107	6,68

5 Divisor balda Shelf divider / Diviseur étagère

N° Art.	€
71106	1,78

2 Empujador Pusher / Pousser

N° Art.	€
71109	1,88

4 Tope trasero / Back block Support adhésif arrière

N° Art.	€
71108	3,87



6 Cartón Fin Gancho Hook End Carton / Carton fin crochet

	N° Art.	€
Plastic Pouch	71118	0,23
Doble Blister	71119	0,23

IMPLANTACIÓN DISPLAY 2 METROS

2 Metre Display Stock Offer

Offre implantation presentoir 2 metres

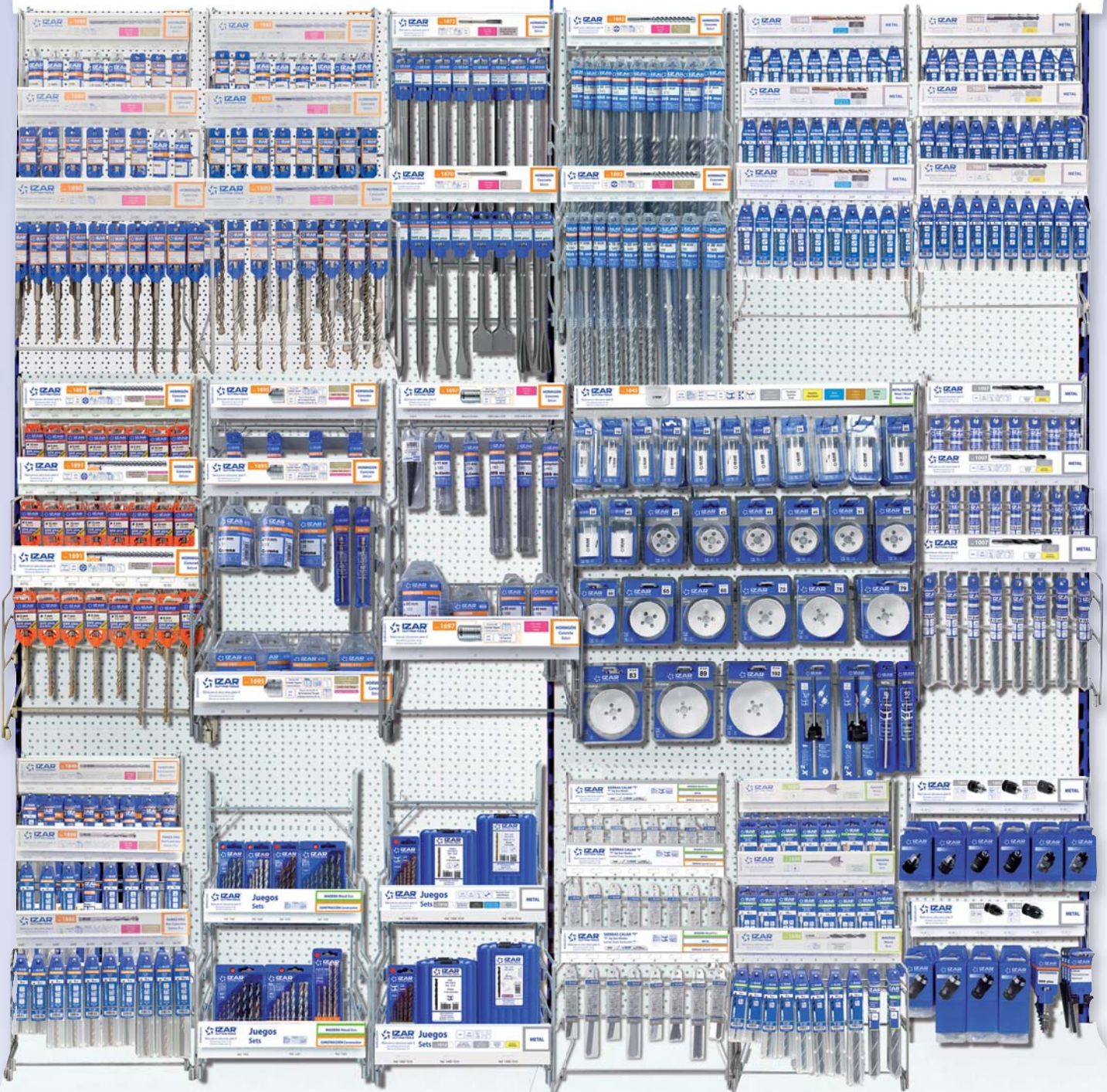

IMPLANTACIÓN DISPLAY 2 METROS

2 Metre Display Stock Offer

Offre implantation presentoir 2 metres

Display
01

BROCA-MARTILLO SDS PLUS 1

SDS plus Rotary Hammer Drill Bit 1
Foret percussion SDS plus 1

Ref. 4995 - N° Art. 22182: 558,72 €

>> Pag. 215

Display
02

BROCA-MARTILLO SDS PLUS 2

SDS plus Rotary Hammer Drill Bit 2
Foret percussion SDS plus 2

Ref. 4995 - N° Art. 22183: 659,72 €

>> Pag. 215

Display
03

BROCA-MARTILLO SDS MAX 4 PUNTAS

4-Cutter SDS max Rotary Hammer Drill Bit
Foret percussion SDS max 4 pointes

Ref. 4995 - N° Art. 22315: 1.382,87 €

>> Pag. 221

Display
04

CINCELES SDS MAX / PLUS

SDS max / plus Chisels
Burins SDS max / plus

Ref. 4995 - N° Art. 22289: 460,10 €

>> Pag. 228

Display
05

CORONA LIGERA PARED PROFESIONAL

Professional Concrete Light Hollow Core Bit
Trépan béton professionnel

Ref. 4995 - N° Art. 22418: 698,43 €

>> Pag. 219

Display
06

CORONA PERFORADORA TALADRO PERCUTOR HORMIGÓN

Tapered Hollow Hammer Core Bit
Trépan pour perceuses percussion lourds béton

Ref. 4995 - N° Art. 22463: 905,23 €

>> Pag. 223

Display
07

BROCA PUNTA METAL DURO PARED PROFESIONAL

Professional Concrete Carbide Tipped Drill Bit
Foret pointe carbure béton professionnel

Ref. 4995 - N° Art. 22191: 604,04 €

>> Pag. 236

Display
10

BROCAS MADERA PALA Y 3 PUNTAS

Wood Drill Bits Flat & 3-Pointed
Forets bois mèches plates & 3-pointes

Ref. 4995 - N° Art. 22184: 339,32 €

>> Pag. 271

Display
12

PORTA-BROCAS TALADROS PORTÁTILES Y ESTACIONARIOS

Portable & Stationary Drilling Machine Drill-Chucks
Mandrins perceuses portables & fixes

Ref. 4995 - N° Art. 22334: 858,24 €

>> Pag. 83

Display
13

BROCA MANGO CILÍNDRICO COBALTO

Cobalt Straight Shank Drill Bit
Foret queue cylindrique Cobalt

Ref. 4995 - N° Art. 22181: 601,73 €

>> Pag. 27

Display
14

BROCA MANGO CILÍNDRICO HSS

HSS Straight Shank Drill Bit
Foret queue cylindrique HSS

Ref. 4995 - N° Art. 22162: 425,18 €

>> Pag. 51

Display
18

BROCA MANGO REBAJADO HSS

HSS Reduced Shank Drill Bit
Foret queue réduit HSS

Ref. 4995 - N° Art. 22352: 629,17 €

>> Pag. 65

Display
19

SIERRA CORONA METAL / MADERA

METAL / WOOD Hole Saw
Trépan MÉTAL / BOIS

Ref. 4995 - N° Art. 22220: 934,49 €

>> Pag. 248

Display
20

SIERRAS CALAR INSERCIÓN "T"

"T" Insertion Jig Saw Blades
Lames scies insertion "T"

Ref. 4995 - N° Art. 22391: 342,16 €

>> Pag. 356

Display
23

JUEGOS CASSETTE MADERA Y CONSTRUCCIÓN

Wood & Construction Cassette Sets
Jeux cassette Bois & Construction

Ref. 4995 - N° Art. 22372: 419,23 €

>> Pag. 272

Display
24

SETS BROCAS MANGO CILINDRICO HSS + HSSE

HSS + HSSE Straight Shank Drill Bit Sets
Jeux forets queue cylindrique HSS + HSSE

Ref. 4995 - N° Art. 22320: 516,71 €

>> Pag. 29

Display
61

BROCA-MARTILLO SDS PLUS 4Z

4Z Cutter SDS plus Rotary Hammer Drill Bit
Foret percussion SDS plus 4Z

Ref. 4995 - N° Art. 29487: 456,21 €

>> Pag. 212



TOTAL: 10.791,54 €

IMPLANTACIÓN DISPLAY 1 METRO

1 Metre Display Stock Offer

Offre Implantation presentoir 1 metre



Display 01

BROCA-MARTILLO SDS PLUS 1
SDS plus Rotary Hammer Drill Bit 1
Foret percussion SDS plus 1

Ref. 4995 - N° Art. 22182: **558,72 €**

>> Pag. 215

Display 02

BROCA-MARTILLO SDS PLUS 2
SDS plus Rotary Hammer Drill Bit 2
Foret percussion SDS plus 2

Ref. 4995 - N° Art. 22183: **659,72 €**

>> Pag. 215

Display 07

BROCA PUNTA METAL DURO PARED PROFESIONAL
Professional Concrete Carbide Tipped Drill Bit
Foret pointe carbure béton professionnel

Ref. 4995 - N° Art. 22191: **604,04 €**

>> Pag. 236

Display 10

BROCAS MADERA PALA Y 3 PUNTAS
Wood Drill Bits Flat & 3-Pointed
Forets bois mèches plates & 3-pointes

Ref. 4995 - N° Art. 22184: **339,32 €**

>> Pag. 271

Display 13

BROCA MANGO CILÍNDRICO COBALTO
Cobalt Straight Shank Drill Bit
Foret queue cylindrique Cobalt

Ref. 4995 - N° Art. 22181: **601,73 €**

>> Pag. 27

Display 14

BROCA MANGO CILÍNDRICO HSS
HSS Straight Shank Drill Bit
Foret queue cylindrique HSS

Ref. 4995 - N° Art. 22162: **425,18 €**

>> Pag. 51

Display 19

SIERRA CORONA METAL / MADERA
METAL / WOOD Hole Saw
Trépan MÉTAL / BOIS

Ref. 4995 - N° Art. 22220: **934,49 €**

>> Pag. 248

Display 23

JUEGOS CASSETTE MADERA Y CONSTRUCCIÓN
Wood & Construction Cassette Sets
Jeux cassette Bois & Construction

Ref. 4995 - N° Art. 22372: **419,23 €**

>> Pag. 272

TOTAL: 4.542,42 €



ACCESORIOS DISPLAYS

Display Accessories
Accessoires presentoir

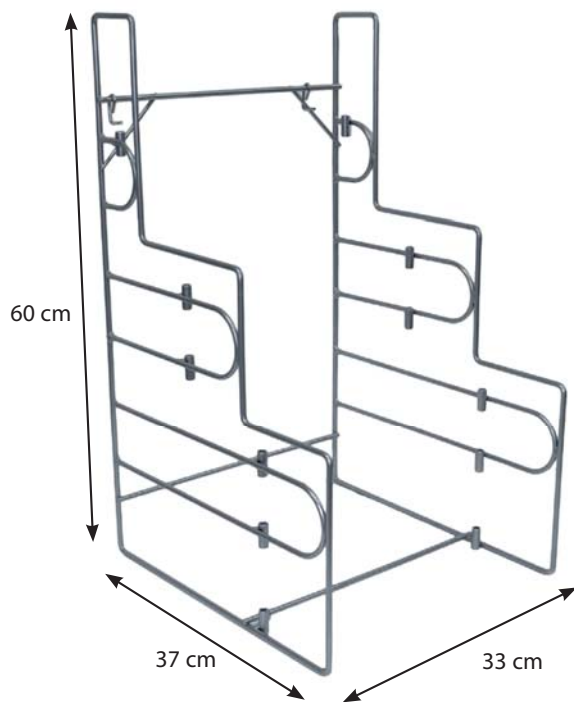

Display-Cascada
Cascade-Display
Display-Cascade

N° Art.	€
20182	47,04

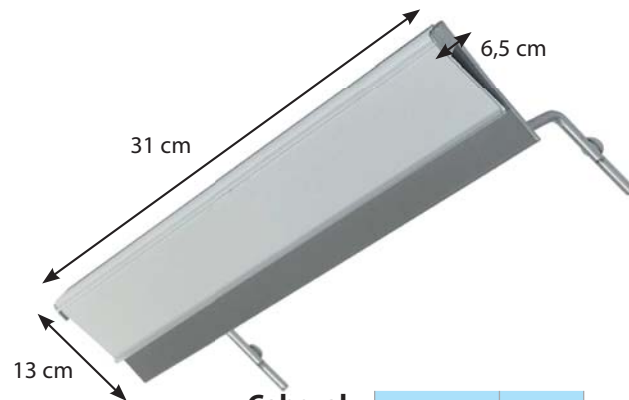

Cabezal
Header
Tête

N° Art.	€
22651	13,28

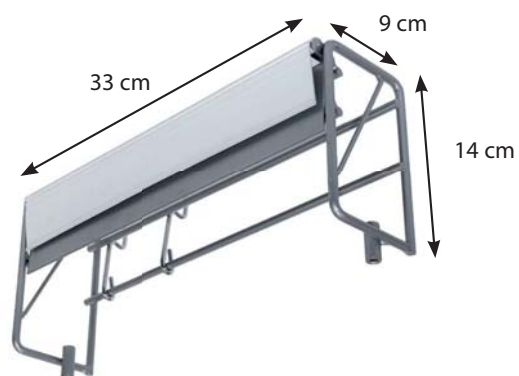

Display-Línea
Line-Display
Display-Ligne

N° Art.	€
22650	29,14



Gancho-08
Hook-08
Crochet-08

N° Art.	€
51837	11,76



Gancho-10
Hook-10
Crochet-10

N° Art.	€
51840	12,52



Gancho-06-Doble
Hook-06-Double
Crochet-06-Double

N° Art.	€
22653	13,05

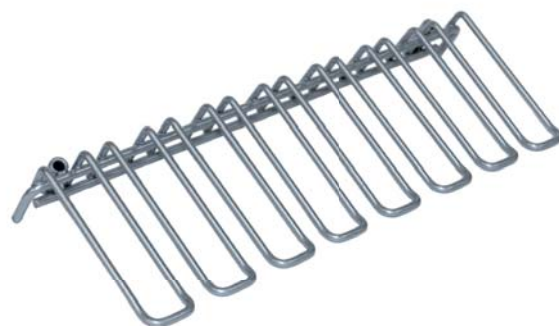

Gancho-08-Doble
Hook-08-Double
Crochet-08-Double

N° Art.	€
33241	14,87

SISTEMA DE EXPOSITORES APILABLES

Stacking Exhibitors System
Système présentoirs empilables



Expo
1602 1.

EXPOSITOR BROCAS ESCALONADAS

Step Drill Display
Présentoirs forets étagés

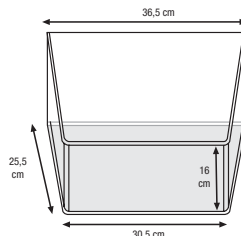

15 Pcs

N° Art. **1.486,06**
65184 €

Cap. mm	N° Art.	Uds.
4-12	12048	2
4-20	12054	2
6-30	12060	2
9-36	12066	2
12-20	56798	2
20-30	56799	2
30-40	60715	1
40-50	60716	1
50-60	60717	1

Expo
9200 2.

EXPOSITOR FRESAS ROTATIVAS

Rotary Burr Display
Présentoirs fraises limes rotativas carbure

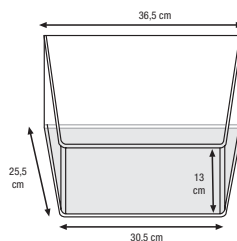

48 Pcs

N° Art. **1.509,78**
57079 €

Ref.	Diam. mm	N° Art.	Uds.
9260	06,00X06,00	44141	2
	08,00X06,00	44142	2
	09,60X06,00	44143	2
	12,70X06,00	44144	2
9251	06,00X06,00	44438	2
	08,00X06,00	44439	2
	09,60X06,00	44440	2
	12,70X06,00	44441	2
9254	06,00X06,00	44488	2
	08,00X06,00	44494	2
	09,60X06,00	44500	2
	12,70X06,00	44512	2
9258	06,00X06,00	44721	2
	08,00X06,00	44722	2
	09,60X06,00	44723	2
	12,70X06,00	44724	2
9267	06,00X06,00	44792	2
	08,00X06,00	44793	2
	10,00X06,00	44794	2
	12,70X06,00	44795	2
9268	06,00X06,00	44808	2
	08,00X06,00	44809	2
	09,60X06,00	44811	2
	12,70X06,00	44814	2

Expo
1667 3.

EXPOSITOR CORONAS REAFILABLES HSS

HSS Resharpenable Hole Saw Exhibitor
Présentoir fraises à trépaner HSS

31 Pcs

N° Art. **1.002,63**
66804 €

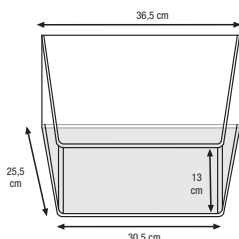

Diam.	N° Art.	Uds.	Diam.	N° Art.	Uds.	Diam.	N° Art.	Uds.	Diam.	N° Art.	Uds.
12	56569	1	20	56154	1	28	56587	1	39	56594	1
13	56570	1	21	56582	1	29	56588	1	40	56161	1
14	56572	1	22	56155	1	30	56158	1	42	56596	1
15	56573	1	23	56583	1	32	56159	1	45	56597	1
16	56152	1	24	56584	1	33	56590	1	48	56163	1
17	56576	1	25	56156	1	35	56160	1	50	56164	1
18	56578	1	26	56585	1	36	56591	1	65	56602	1
19	56579	1	27	56157	1	38	56593	1			

CONDICIONES GENERALES VENTA

General Selling Conditions

Conditions générales de vente en France

1. VENCIMIENTOS FIJOS

En caso de fechas fijas de pago que rebasen los plazos estipulados giraremos a la fecha fijada pero inmediata anterior, según corresponda, siendo el plazo máximo en todo caso de 60 días, fecha factura o envío.

2. SEGURO

Las mercancías viajarán por exclusiva cuenta y riesgo del comprador, siendo siempre a cargo del mismo la prima del seguro que se realice, en los casos que el cliente desee asegurarla.

3. RECLAMACIONES

Se atenderán aquellas reclamaciones que se planteen dentro de los 8 días siguientes a la recepción del material no aceptando ninguna devolución sin el previo conocimiento de IZAR Cutting Tools S.A.L.

4. DEVOLUCIONES

Sólo se aceptarán las devoluciones por defecto de fabricación o error atribuible a IZAR. No se aceptarán devoluciones sin previa autorización de IZAR o de nuestro delegado o representante. Las devoluciones serán a portes pagados e irán acompañadas de la factura original. No se admitirán devoluciones procedentes de promociones ni en estuches defectuosos. Toda devolución originará una nota de cargo del 20% de su valor en concepto de manipulación e inspección de control de calidad.

5. CONDICIONALIDAD

La aceptación de las mercancías sin el rechazo inmediato por parte del comprador supone la aprobación de estas condiciones generales de venta y su modificación solamente tendrá validez si consta por escrito la conformidad de IZAR.

6. I.V.A.

Los precios están sujetos al Impuesto sobre el Valor Añadido, siendo a cargo del cliente el recargo correspondiente.

7. GARANTÍAS

Todas las herramientas están garantizadas contra cualquier defecto de fabricación y materiales, sin responsabilizarse IZAR de su utilización inadecuada. En todo caso, nuestra responsabilidad estará limitada al valor de la herramienta suministrada. Nos reservamos el derecho de modificar, sin previo aviso, las dimensiones, calidades del acero y, en general, todas las características técnicas de las herramientas. No será

sustituída ninguna herramienta sin el informe previo de nuestro Dpto. de Control de Calidad.

8. PORTES

Se suministrarán con franquicia de portes todos aquellos envíos cuyo valor neto de factura supere los 180 € netos por cada envío en territorio peninsular e Islas Baleares; 300 € en Canarias, Ceuta, Melilla y Andorra. En cualquier caso IZAR se reserva el derecho de utilizar el medio de envío más económico. En las capitales donde IZAR tenga establecidos depósitos de distribución, esta cláusula se aplicará para las reexpediciones a otras poblaciones de la provincia.

9. IMPORTE MÍNIMO POR PEDIDO

Queda establecido como pedido mínimo la cantidad de 60 € netos. Los pedidos inferiores se cobrarán al contado o por reembolso.

10. RESERVA DE DOMINIO

Nuestras ventas se consideran siempre bajo la condición de Reserva de dominio según el artículo 1.506 C.C. hasta que se haya hecho efectivo íntegramente el pago de todo lo adeudado.

11. JURISDICCIÓN COMPETENTE

Para cualquier discrepancia acerca de la interpretación de estas condiciones o litigio por razón de incumplimiento por cualquiera de las partes se someten ambas al fuero de los Juzgados y Tribunales de Bilbao, con renuncia al que pudiera corresponderles.

12. NOTA IMPORTANTE SOBRE DISPLAYS MODULARES

Los Displays Modulares son propiedad de IZAR y la cesión sin costo para su uso a nuestros clientes se hace bajo las siguientes condiciones:

- Pedido inicial del Programa Completo.
- Uso único y exclusivo para los productos suministrados por IZAR.
- Ejercicio de un mantenimiento razonable que evite daños al Display.

El sistema de Displays modulares está patentado por IZAR. La infracción de dicha patente dará lugar a las acciones legales pertinentes.

1. ECHEANCES

Quelle que soit la date fixée pour le paiement des factures, celui-ci doit être effectué au maximum 30 jours après l'envoi ou la date de facture.

2. ASSURANCE

Le risque lié à l'envoi des marchandises est assumé exclusivement par l'acheteur, toute latitude lui étant laissée s'il désire les assurer.

3. RECLAMATIONS

Seront prises en compte les réclamations portées à la connaissance d'IZAR Cutting Tools S.A.L. dans un délai de 8 jours suivant la réception des marchandises. Aucun retour ne sera accepté si cette condition préliminaire n'est pas satisfaite.

4. RETOURS

Seront acceptés les retours de marchandises pour défaut de fabrication ou erreur imputable à IZAR. Ne sera accepté aucun retour de marchandises sans accord préalable de notre part ou de notre représentant.

Les retours s'effectueront port payé et seront accompagnés de la facture originale. En aucun cas ne seront acceptés les retours de marchandises liées à des promotions ou en emballages defectueux. Les avoirs seront minorés de 20% de la valeur de la marchandise pour manipulation et inspection du contrôle de qualité.

5. CONDITIONNALITE

L'acceptation des marchandises de la part de l'acheteur implique l'acceptation de ces conditions générales de vente et leur modification ne sera valable qu'après approbation écrite de la part d'IZAR.

6. T.V.A.

Les prix ne sont pas assujettis à la Taxe sur la Valeur Ajoutée.

7. GARANTIES

Tous les outils sont garantis contre les défauts de fabrication, IZAR ne pouvant en aucun cas être rendu responsable en cas d'utilisation

inadéquate de ceux-ci. En tout état de cause, notre responsabilité se limitera à la valeur de l'outil fourni. Nous nous réservons le droit de modifier, sans information préalable, les dimensions, qualités d'acier et en général toutes les caractéristiques techniques des outils. Aucun outil ne sera remplacé sans l'avis préalable de notre département de contrôle de qualité.

8. PORTS

Seront expédiées en franco de port en France Métropolitaine toutes les commandes dont le montant net dépasse les 300 €. IZAR se réserve le droit d'utiliser le moyen de transport le plus économique.

9. MONTANT MINIMUM DES COMMANDES

Le montant minimum des commandes est de 60 € nets.

10. RESERVE DE PROPRIETE

IZAR conserve tous les droits de propriété sur ses ventes jusqu'au paiement intégral des sommes dues.

11. JURIDICTION COMPETENTE

Tout litige relatif à l'interprétation de ces conditions ou au manquement de l'une des parties à ses obligations est de la compétence du Tribunal de Commerce de Bilbao.

12. NOTE IMPORTANTE SUR LES PRESENTOIRS MODULAIRES











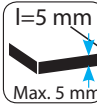

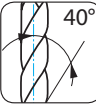
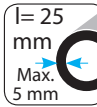

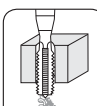

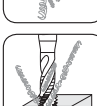

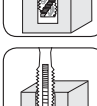
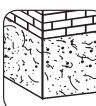

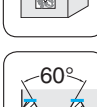

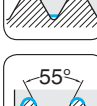



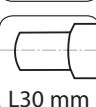
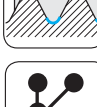

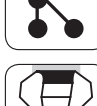

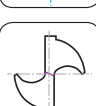
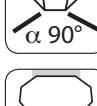

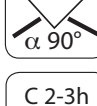
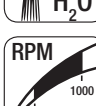

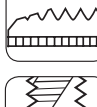
Les présentoirs modulaires sont propriété d'IZAR et leur cession sans coût à nos clients pour leur utilisation se fait sous les conditions suivantes:

- Commande initiale du programme complet.
- Utilisation exclusive de produits fournis par IZAR.
- Entretien raisonnable qui évite les dommages au présentoir.

Le système de présentoirs modulaires est breveté par IZAR. Le non-respect dudit brevet donnera lieu aux actions légales nécessaires.

ÍNDICE SÍMBOLOS

Symbol Index
Index de symboles

	Ángulo Punta Point Angle Angle de pointe		Espesor Material Material Thickness Épaisseur matériel		Corte a Izquierda Left hand Cutting Coupe à gauche
	Ángulo de Hélice Helix Angle Angle d'hélice		Espesor Tubo Pipe Thickness Épaisseur tuyau		Magnético Magnetic Magnétique
	Afilado en Cruz Tipo DIN 1412 "C" Split Point DIN 1412 "C" type		Agujero Pasante Through Hole Trou débouchant		Cabezal Zentro4 Zentro4 head Tête Zentro4
	Affûtage en croix type DIN 1412 "C"		Agujero Ciego Blind Hole Trou borgne		Hormigón Reforzado Reinforced Concrete Béton armé
	Punta Centrar DIN 1412 E Center Point DIN 1412 E		Agujero Ciego Blind Hole Trou borgne		Hormigón Concrete Béton
	Pointe à Centrer DIN 1412 E		Rosca Standard Standard Thread Filetage standard		Hormigón Bloque Concrete Block Parpaing
	Mango 3 Planos 3-Flat Shank Attachement 3 plans		Rosca de tubo cilíndrica Straight Pipe Thread Filetage tubes cylindriques		Ladrillo Brick Brique
	Taladro Portátil Portable Drilling Machine Perceuse à main		Rosca Whitworth cilíndrica Straight Whitworth Thread Filetage Whitworth cylindrique		Cabezal 4 Puntas 4-Cutter Head Tête 4 pointes
	Mango Rebajado Reduced Shank Queue réduit		Plástico Plastic Plastique		Punta MD Afilada Carbide Split Point Affûtage pointe carbure
	Punta Metal Duro Carbide Tipped Pointe carbure		Ángulo Avellanado Countersinking Angle Angle de fraisage		Porcelánico Porcelain Porcelaine
	Afilado Universal Universal Point Affûtage universel		Ángulo Avellanado Countersinking Angle Angle de fraisage		Refrigeración Agua Water Cooling Refrigeration eau
	Sin Percusión No Percussion Sans percussion		Entrada Macho Tap Point Entrée de taraud		Herramienta Diamante Diamond Tool Outil diamant
	Percusión Percussion Percussion		Ángulo de Hélice Helix Angle Angle d'hélice		Amoladora Disc Grinder Meuleuse
	Ángulo Broca Escalonada Step Drill Angle Angle de foret etagé		Entrada GUN GUN Chamfer Entrée GUN		Cerámica Ceramics Céramique
	Conicidad Taper Conicité		Corte al Centro Center Cutting Coupe au centre		Madera Wood Bois
	Puntos Soldadura Welding Point Points soudure		Sin Corte al Centro Non Center Cutting Sans coupe au centre		Vidrio Glass Verre

ÍNDICE SÍMBOLOS

Symbol Index
Index de symboles



Metal
Metal
Métal



Máquina Perforadora
Core Drilling Machine
Carotteuse électrique

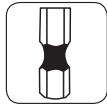

Inserción Rápida 1/4
Quick Shank 1/4
Attache rapide 1/4



Bujía
Spark Plug
Bougie



Abrasivos
Abrasives
Abrasifs



Pulido
Sanding
Poncer



Mármol
Marble
Marbre



Perfil Parabólico "S"
S Parabolic Profile
Profil parabolique S



Madera Blanda
Soft Wood
Bois tendre



Madera Dura
Hard Wood
Bois dur

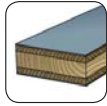

Contrachapado
Plywood
Contreplaqué



Madera+Clavos
Wood+Nails
Bois+Clous



Metal
Metal
Métal

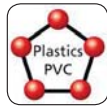

Plástico
Plastics
Plastique



Cristal
Glass
Verre



Válido Mango Multi-Función
Multi-Tool
Multifonction



Fibra Vidrio
Fibreglass
Fibre verre



Pladur
Drywall
Plâtre



No ferrosos
Non-ferrous
Non ferreux

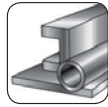

Perfiles
Profiles
Profils



Parquet-Laminados
Laminated-Parquet
Parquet-laminés



GFK

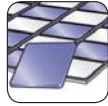

Cerámica
Ceramics
Céramique



Grout-Mortero
Grout-Mortar
Coulées-Mortier

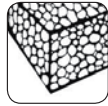

Aislamiento
Isolating
Isolant



Caucho
Rubber
Caoutchouc



Cuero
Leather
Cuir



Restos blandos (pegamento, moqueta, silicona...)
Soft remains (glue, carpet, silicone...)
Restes tendres (colle, moquette, silicone...)



Distancia entre Dientes
Distance among Teeth
Distance entre les dents

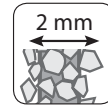

2 mm
Espesor Dentado
Teeth Thickness
Épaisseur denture



Tipo Dentado
Teeth Type
Type denture

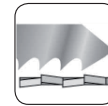

Dentado Alterno Basto
Rough Side Teeth
Denture avoyée gros

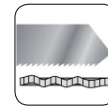

Dentado Ondulado Fino
Fine Wavy Teeth
Denture ondulé fin

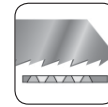

Dentado Rectificado Cónico
Conically Ground Teeth
Denture conique dépoluillée



Dentado Alterno Diagonal
Diagonally Side Teeth
Denture avoyée diagonale



Punta Atornillar HEX
HEX Screwdriver Bit
Embout vissage HEX



Punta Atornillar PH
PH Screwdriver Bit
Embout vissage PH



Punta Atornillar PZ
PZ Screwdriver Bit
Embout vissage PZ



Punta Atornillar SL
SL Screwdriver Bit
Embout vissage SL



Punta Atornillar Tx
Tx Screwdriver Bit
Embout vissage Tx



Punta Atornillar Ts
Ts Screwdriver Bit
Embout vissage Ts



P. Atornillar SQUARE ROBERTSON
SQUARE ROBERTSON Screwdriver Bit
Embout vissage SQUARE ROBERTSON



Punta Atornillar TRIWING
TRIWING Screwdriver Bit
Embout vissage TRIWING



Punta Atornillar XZN
XZN Screwdriver Bit
Embout vissage XZN



Entrada Hexagonal
HEX Input
Entrée hexagonale

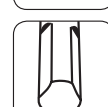

Mango 3 Planos
3-Flat Shank
Attachement 3 plans

Búsqueda por referencia (REF. - PÁGINA)

Search by reference (Ref. - Page)

Recherche par référence (Ref. - Page)

Ref.	Pag.	Ref.	Pag.	Ref.	Pag.	Ref.	Pag.	Ref.	Pag.	Ref.	Pag.	Ref.	Pag.
1001	50	1470	30-54-64	1663	113	1871	229	3001	130	4060	108	8925	196
1002	60	1476	69	1664	111-114	1872	227	3003	122	4061	109	8930	197
1003	72	1482	230	1665	114	1875	225	3005	149	4062	110	8940	197
1004	19	1485	241	1667	111	1876	243	3006	149	4067	107	8950	198
1005	34	1486	237	1669	285	1877	233	3010	128	4070	99	8960	198
1006	26	1487	237	1670	287	1879	231	3012	134	4071	100	8970	199
1007	65	1488	241	1671	287	1880	238	3016	136	4072	101	8990	200
1009	75	1489	213	1672	288	1881	242	3020	126	4074	104	8991	200
1010	45	1490	75	1673	288	1882	230	3023	131	4075	97/110	8992	201
1012	66	1491	75	1674	286	1883	232	3026	135	4076	103		
1013	56	1492	75	1676	286	1886	234	3030	121	4077	98	9001	293
1015	40	1494	218	1677	287	1889	242	3032	133	4078	97	9015	38
1016	22	1497	218	1678	286	1890	214	3036	124	4079	102	9016	154
1020	31	1499	75	1679	285	1891	210	3037	125				
1021	16			1681	288	1892	220	3040	132	4223	187	9100	39
1025	67	1510	365	1682	289	1894	222			4228	189		
1027	37	1520	358	1685	285	1899	218	3100	137	4229	191	9200	180
1030	70	1521	362	1686	289			3109	143			9230	177
1040	74	1522	363	1689	293	1910	347	3113	142	4412	185	9231	177
1050	69	1523	363	1690	296	1915	355	3119	141	4414	185	9237	178
1065	43	1524	364	1695	219	1920	325	3150	139			9238	178
1090	75	1527	365	1696	219	1930	352	3157	145	7001	295	9240	176
		1529	366	1697	223	1940	338	3181	156	7002	294	9247	179
				1698	223	1945	353	3184	156	7003	295	9248	179
1101	84			1699	244	1950	322	3191	153	7009	294	9250	171
1102	84	1601	245			1960	330					9251	171
1103	85	1602	87	1802	79	1994	192	3200	138			9252	172
1104	85	1603	92	1803	81	1996	192	3250	140	8301	202	9254	172
1110	76	1604	95	1804	80	1997	192			8302	202	9255	173
		1605	95	1806	80	1999	192	3300	165	8303	202	9256	173
1405	29-54-55	1606	95	1807	79			3303	167	8304	202	9257	174
1406	30-44-54-64	1607	90	1809	82	2010	116	3305	166	8309	264	9258	174
1407	29-54-55	1609	93	1819	82	2015	117	3307	167	8310	203	9260	170
1408	30-54-55	1610	96	1836	244	2016	117	3310	168	8318	264	9266	175
1409	29-54-55	1611	94	1846	235	2017	117	3311	168	8319	265	9267	175
1410	30-44-54-64	1612	89	1849	263	2530	119	3312	169	8320	264-265-266	9268	176
1435	273	1615	291	1851	258	2572	120			8321	207	9289	38
1438	273	1617	91	1852	258	2575	118	3404	157	8325	206		
		1620	292	1853	260			3405	157	8326	207	9411	184
		1621	282	1854	259	2900	316	3406	158	8330	206	9419	184
1456	21-28-36-44-52-55-63-64	1625	292	1855	260	2910	305	3407	367	8331	266	9459	183
		1636	115	1857	261	2930	310	3409	155	8335	206		
1459	21-28-36-44-52-63	1637	284	1858	259	2940	301	3415	159	8341	206	9674	182
		1639	283	1860	256	2950	318			8342	207		
1460	241-273	1640	270	1861	261	2960	319	3500	147	8345	208	9994	86
		1641	268	1862	262			3502	151	8350	204		
1461	94-246-282-284-368	1642	254	1863	263			3506	152	8351	205	M007	373
		1643	281	1864	262			3510	151	8352	204	M013	372
		1644	280	1869	213			3536	150			M020	371
1462	21-28-36-44-52-63-67	1645	247	1870	226			3546	152	8900	194	M021	370
		1646	254							8901	194	M640	379
		1647	250							8904	195	M650	380
1466	21-28-36-44-52-55-63-64-67	1650	276							8910	195	M836	378
		1651	274							8920	196	M880	377
		1653	274									M881	378
		1655	278									M882	375
		1659	113									M886	376
		1660	68									M890	374
		1661	252										
		1662	253										

Búsqueda por referencia (DISPLAY - PÁGINA)

Search by reference (Display - Page)

Recherche par référence (Display - Page)

Ref.	Pag.	Ref.	Pag.	Ref.	Pag.	Ref.	Pag.	Ref.	Pag.	Ref.	Pag.
D-01	215	D-13	27	D-25	216	D-37	230	D-49	35	D-61	212
D-02	215	D-14	51	D-26	216	D-38	279	D-50	20	D-62	20
D-03	221	D-15	73	D-27	217	D-39	279	D-51	52-240-271	D-63	360
D-04	228	D-16	35	D-28	217	D-40	279	D-52	20-236-269	D-64	290
D-05	219	D-17	61	D-29	217	D-41	281	D-53	317	D-65	112
D-06	223	D-18	65	D-30	217	D-42	281	D-54	95-245-283	D-66	114
D-07	236	D-19	248	D-31	213	D-43	149	D-55	269-275	D-67	212
D-08	239	D-20	356	D-32	213	D-44	123	D-56	275	D-68	212
D-09	239-242	D-21	356	D-33	221	D-45	216	D-57	275	D-69	233
D-10	271-277	D-22	123	D-34	221	D-46	51	D-58	269	D-70	231
D-11	279	D-23	236-272	D-35	228	D-47	62	D-59	62-240-272	D-71	360
D-12	83	D-24	29-53	D-36	228	D-48	27	D-60	251	D-72	243

Búsqueda por referencia (LÍNEA - PÁGINA)

Search by reference (Line - Page)

Recherche par référence (Ligne - Page)

Línea	Pag.	Línea	Pag.	Línea	Pag.
L-1001-1M	51	L-1645-1M	248	L-3409	155
L-1002-1M	61	L-1647-1M	251	L-3500	148
L-1003-1M	73	L-1650-1M	277	L-3510	151
L-1004-1M	19	L-1651-1M	274	L-3536	150
L-1005-1M	35	L-1655-1M	278	L-3912	153
L-1006-1M	27	L-1667-1M	112	L-4060	108
L-1007-1M	65	L-16FM-1M	290	L-4061	109
L-1010-1M	48	L-1836	244	L-4062	110
L-1013-1M	58	L-1846-1M	235	L-4067	107
L-1015-1M	42	L-1870	228	L-4070	99
L-1016-1M	24	L-1879	231	L-4071	100
L-1020-1M	32	L-1880-1M	238	L-4072	101
L-1021-1M	17	L-1881	242	L-4076	103
L-1027-1M	37	L-1883-1M	232	L-4077	98
L-14S1	53-237- 241-273	L-1886-1M	234	L-4078	97
L-14S2	218-237- 241	L-1890-1M	215	L-4079	102
L-1601	245	L-1891-1M	211	L-9200	170
L-1602	88	L-1892-1M	220	L-M007-1M	373
L-1603	92	L-18PB	83	L-M013-1M	372
L-1607	90	L-18PB-1M	83	L-M020-1M	371
L-1609	93	L-19C1-1M	356	L-M021-1M	370
L-1610	96	L-19C2-1M	356	L-M640-1M	379
L-1611	94	L-19SS-1M	335	L-M650-1M	380
L-1612	89	L-2530	119	L-M836	378
L-1615	291	L-2572	120	L-M880-1M	377
L-1617	91	L-2575	118	L-M881	378
L-1620	292	L-2900-1M	317	L-M882-1M	375
L-1621	282	L-3001	130	L-M886-1M	376
L-1625	292	L-3003	122	L-M890	374
L-1639	283	L-3023	131	L-M890-1M	374
L-1640-1M	270	L-3109	144		
L-1641	268	L-3119	141		
L-1644-1M	280	L-3157	146		
		L-3191	153		



COMERCIAL NACIONAL

E-mail comercial@izartool.com

Pedidos y Atención a Clientes

Tel. 94 630 02 41

Fax 94 630 02 36

Servicio Técnico

Tel. 94 630 02 43

Fax 94 630 05 42

EXPORT SALES

E-mail export@izartool.com

Orders & Customer Assistance

Tel. +34 94 630 02 46

Fax +34 94 630 02 37

VENTES FRANCE

Courriel france@izartool.com

Tel. +34 94 630 02 45

Parque Empresarial Boroa 2B2 - 48340 Amorebieta, Bizkaia (Spain)



LA CALIDAD TOTAL NOS DISTINGUE

Quality makes the difference

La qualité totale nous différencie



Comprometidos con los objetivos de crecimiento sostenible de la ONU

Committed to the United Nations Sustainable Growth Goals

Engagés envers les objectifs de croissance durable des Nations Unies

Todas nuestras publicaciones se imprimen en papel procedente de fuentes responsables con el medioambiente y la sociedad

All our publications are printed on paper from environmentally and socially responsible sources

Toutes nos publications sont imprimées sur du papier issu de sources écologiquement et socialement responsables



8 424448 247483

izartool.com